

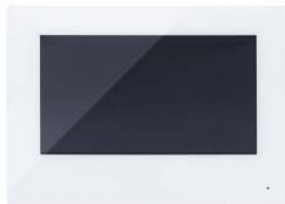

Security Tech Germany

# MODUVIS Türsprechanlage TVHS20XXX(S)



Ⓟ

## Bedienungsanleitung

Version 06/2021 (V1.2)



<p><b>(D)</b></p>	<p><b>Diese Bedienungsanleitung enthält wichtige Hinweise zur Inbetriebnahme und Handhabung. Achten Sie hierauf, auch wenn Sie dieses Produkt an Dritte weitergeben. Heben Sie deshalb diese Bedienungsanleitung zum Nachlesen auf!</b></p> <p>Eine Auflistung der Inhalte finden Sie im Inhaltsverzeichnis mit Angabe der entsprechenden Seitenzahlen auf <b>Seite 8</b>.</p>	<p><b>(DK)</b></p>	<p><b>Denne manual hører sammen med dette produkt. Den indeholder vigtig information som skal bruges under opsætning og efterfølgende ved service. Dette skal huskes også når produkter gives videre til anden part. Læs derfor denne manual grundigt igennem også for fremtiden.</b></p> <p>Indholdet kan ses med sideanvisninger kan findes i indekset på <b>side 299</b>.</p>
<p><b>(GB)</b></p>	<p><b>This user manual contains important information for installation and operation. This should be also noted when this product is passed on to a third party. Therefore look after these operating instructions for future reference!</b></p> <p>A list of contents with the corresponding page number can be found in the index on <b>page 82</b>.</p>		
<p><b>(FR)</b></p>	<p><b>Ce mode d'emploi appartient à de produit. Il contient des recommandations en ce qui concerne sa mise en service et sa manutention. Veuillez en tenir compte et ceci également lorsque vous remettez le produit à des tiers. Conservez ce mode d'emploi afin de pouvoir vous documenter en temps utile!</b></p> <p>Vous trouverez le récapitulatif des indications du contenu á la table des matières avec mention de la page correspondante á la <b>page 155</b>.</p>		
<p><b>(NL)</b></p>	<p><b>Deze gebruiksaanwijzing hoort bij dit product. Er staan belangrijke aanwijzingen in betreffende de ingebruikname en gebruik, ook als u dit product doorgeeft aan derden. Bewaar deze handleiding zorgvuldig, zodat u deze later nog eens kunt nalezen!</b></p> <p>U vindt een opsomming van de inhoud in de inhoudsopgave met aanduiding van de paginanummers op <b>pagina 226</b>.</p>		



Security Tech Germany

# MODUVIS Türsprechanlage TVHS20XXX(S)

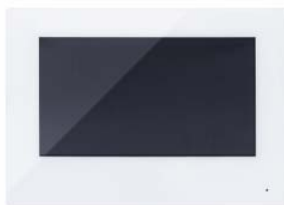

## Bedienungsanleitung

Version 06/2021 (V1.2)



*Originalbedienungsanleitung in deutscher Sprache. Für künftige Verwendung aufbewahren!*

## **DE Einführung**

Sehr geehrte Kundin, sehr geehrter Kunde,

wir bedanken uns für den Kauf dieses Produkts.

### TVHS20000 / TVHS20000S

Das Gerät erfüllt die Anforderungen der folgenden EU-Richtlinien: EMV Richtlinie 2014/30/EU sowie RoHS Richtlinie 2011/65/EU.

### TVHS20010 / TVHS20010S

Das Gerät erfüllt die Anforderungen der folgenden EU-Richtlinien: EMV Richtlinie 2014/30/EU sowie RoHS Richtlinie 2011/65/EU.

### TVHS20020 / TVHS20020S

Das Gerät erfüllt die Anforderungen der folgenden EU-Richtlinien: EMV Richtlinie 2014/30/EU sowie RoHS Richtlinie 2011/65/EU.

### TVHS20030 / THVS20030S

Das Gerät erfüllt die Anforderungen der folgenden EU-Richtlinien: EMV Richtlinie 2014/30/EU sowie RoHS Richtlinie 2011/65/EU.

### TVHS20040

Das Gerät erfüllt die Anforderungen der folgenden EU-Richtlinien: EMV Richtlinie 2014/30/EU sowie RoHS Richtlinie 2011/65/EU.

### TVHS20200

Hiermit erklärt ABUS Security-Center, dass das Gerät der RED-Richtlinie 2014/53/EU entspricht. Die Geräte erfüllen zudem die Anforderungen der folgenden EU-Richtlinien: EMV Richtlinie 2014/30/EU sowie RoHS Richtlinie 2011/65/EU. Der vollständige Text der EU-Konformitätserklärung ist unter den folgenden Internetadressen verfügbar:  
[www.abus.com/product/TVHS20200](http://www.abus.com/product/TVHS20200)

### TVHS20210

Hiermit erklärt ABUS Security-Center, dass das Gerät der RED-Richtlinie 2014/53/EU entspricht. Die Geräte erfüllen zudem die Anforderungen der folgenden EU-Richtlinien: EMV Richtlinie 2014/30/EU sowie RoHS Richtlinie 2011/65/EU. Der vollständige Text der EU-Konformitätserklärung ist unter den folgenden Internetadressen verfügbar:  
[www.abus.com/product/TVHS20210](http://www.abus.com/product/TVHS20210)

### TVHS20220

Hiermit erklärt ABUS Security-Center, dass das Gerät der RED-Richtlinie 2014/53/EU entspricht. Die Geräte erfüllen zudem die Anforderungen der folgenden EU-Richtlinien: EMV Richtlinie 2014/30/EU sowie RoHS Richtlinie 2011/65/EU. Der vollständige Text der EU-Konformitätserklärung ist unter den folgenden Internetadressen verfügbar:  
[www.abus.com/product/TVHS20220](http://www.abus.com/product/TVHS20220)

### TVHS10040 / TVHS20340

Das Gerät erfüllt die Anforderungen der folgenden EU-Richtlinien: EMV Richtlinie 2014/30/EU sowie RoHS Richtlinie 2011/65/EU.

Um diesen Zustand zu erhalten und einen gefahrenlosen Betrieb sicherzustellen, müssen Sie als Anwender diese Bedienungsanleitung beachten!

Lesen Sie sich vor Inbetriebnahme des Produkts die komplette Bedienungsanleitung durch, beachten Sie alle Bedienungs- und Sicherheitshinweise!

**Alle enthaltenen Firmennamen und Produktbezeichnungen sind Warenzeichen der jeweiligen Inhaber. Alle Rechte vorbehalten.**

**Bei Fragen wenden Sie sich an Ihren Fachhändler oder Fachhandelspartner!**



### **Haftungsausschluss**

Diese Bedienungsanleitung wurde mit größter Sorgfalt erstellt. Sollten Ihnen dennoch Auslassungen oder Ungenauigkeiten auffallen, so teilen Sie uns dies bitte mit. Die ABUS Security-Center GmbH & Co. KG übernimmt keinerlei Haftung für technische und typographische Fehler und behält sich das Recht vor, jederzeit ohne vorherige Ankündigung Änderungen am Produkt und an den Bedienungsanleitungen vorzunehmen. ABUS Security-Center ist nicht für direkte und indirekte Folgeschäden haftbar oder verantwortlich, die in Verbindung mit der Ausstattung, der Leistung und dem Einsatz dieses Produkts entstehen. Es wird keinerlei Garantie für den Inhalt dieses Dokuments übernommen.

## Wichtige Sicherheitshinweise



Bei Schäden, die durch Nichtbeachten dieser Bedienungsanleitung verursacht werden, erlischt der Garantieanspruch. Für Folgeschäden übernehmen wir keine Haftung!



Bei Sach- oder Personenschäden, die durch unsachgemäße Handhabung oder Nichtbeachten der Sicherheitshinweise verursacht werden, übernehmen wir keine Haftung. In solchen Fällen erlischt jeder Garantieanspruch!

**Sehr geehrte Kundin, sehr geehrter Kunde,**  
die folgenden Sicherheits- und Gefahrenhinweise dienen nicht nur zum Schutz Ihrer Gesundheit, sondern auch zum Schutz des Geräts. Lesen Sie sich bitte die folgenden Punkte aufmerksam durch:

- Es sind keine für Sie zu wartenden Teile im Inneren des Produkts. Außerdem erlischt durch das Öffnen/Zerlegen die Zulassung (CE) und die Garantie/Gewährleistung.
- Durch den Fall aus bereits geringer Höhe kann das Produkt beschädigt werden.

Vermeiden Sie folgende widrige Umgebungsbedingungen bei Betrieb:

- Nässe oder zu hohe Luftfeuchtigkeit
- Extreme Kälte oder Hitze
- Direkte Sonneneinstrahlung
- Staub oder brennbare Gase, Dämpfe oder Lösungsmittel
- starke Vibrationen
- starke Magnetfelder, wie in der Nähe von Maschinen oder Lautsprechern
- Die Kamera darf nicht auf unbeständigen Flächen installiert werden.

Allgemeine Sicherheitshinweise:

- Lassen Sie das Verpackungsmaterial nicht achtlos liegen! Plastikfolien/-tüten, Styroporsteile usw. könnten für Kinder zu einem gefährlichen Spielzeug werden.
- Die Videoüberwachungskamera darf aufgrund verschluckbarer Kleinteile aus Sicherheitsgründen nicht in Kinderhand gegeben werden.
- Bitte führen Sie keine Gegenstände durch die Öffnungen in das Geräteinnere
- Verwenden Sie nur die vom Hersteller angegebenen Zusatzgeräte/Zubehörteile. Schließen Sie keine nicht kompatiblen Produkte an.
- Bitte Sicherheitshinweise und Bedienungsanleitungen der übrigen angeschlossenen Geräte beachten.
- Überprüfen Sie vor Inbetriebnahme das Gerät auf Beschädigungen, sollte dies der Fall sein, bitte das Gerät nicht in Betrieb nehmen!
- Halten Sie die Grenzen der in den technischen Daten angegebenen Betriebsspannung ein. Höhere Spannungen können das Gerät zerstören und ihre Sicherheit gefährden (elektrischer Schlag).



Vergewissern Sie sich bei Installation in einer vorhandenen Videoüberwachungsanlage, dass alle Geräte von Netz- und Niederspannungsstromkreis getrennt sind.



Nehmen Sie im Zweifelsfall die Montage, Installation und Verkabelung nicht selbst vor, sondern überlassen Sie dies einem Fachmann. Unsachgemäße und laienhafte Arbeiten am Stromnetz oder an den Hausinstallationen stellen nicht nur eine Gefahr für Sie selbst dar, sondern auch für andere Personen.

Verkabeln Sie die Installationen so, dass Netz- und Niederspannungskreise stets getrennt verlaufen und an keiner Stelle miteinander verbunden sind oder durch einen Defekt verbunden werden können.

## Inhaltsverzeichnis

<b>1.</b>	<b>BESTIMMUNGSGEMÄÙE VERWENDUNG .....</b>	<b>10</b>
<b>2.</b>	<b>SYMBOLERKLÄRUNG .....</b>	<b>10</b>
<b>3.</b>	<b>SYSTEMÜBERSICHT .....</b>	<b>11</b>
3.1	2-DRAHT VARIANTE .....	13
3.1.1	KOMPONENTEN .....	13
3.1.2	EMPFOHLENE KABELTYPEN.....	14
3.2	IP NETZWERK VARIANTE.....	14
3.2.1	KOMPONENTEN .....	14
3.3	INSTALLATIONSKOMPONENTEN.....	15
3.4	SYSTEMVARIANTEN .....	16
<b>4.</b>	<b>INBETRIEBNAHME .....</b>	<b>21</b>
4.1	INSTALLATION UND VERDRAHTUNG.....	21
4.2	AKTIVIERUNGSMÖGLICHKEITEN / ERSTKENNWORTVERGABE .....	22
4.2.1	AKTIVIERUNG ÜBER TÜRSTATIONSMONITOR.....	22
4.2.2	AKTIVIERUNG ÜBER IP NETZWERK .....	25
4.2.3	PASSWORT-RESET MONITOR/VIDEO-TÜRMODUL .....	25
<b>5.</b>	<b>BEDIENUNG DES MONITORS (2-DRAHT &amp; IP) .....</b>	<b>26</b>
5.1	LIVEBILD.....	26
5.2	HAUPTSEITE ÜBERSICHT.....	27
5.2.1	MENÜPUNKT: ANRUF-EINSTELLUNGEN.....	32
5.2.2	WLAN EINSTELLUNGEN.....	35
5.2.3	ETAGENTASTER.....	36
5.2.4	SONSTIGE EINSTELLUNGEN .....	37
5.2.4.1	KONFIGURATION – LOKALE INFORMATIONEN.....	37
5.2.4.2	KONFIGURATION – NETZWERKEINSTELLUNGEN.....	41
5.2.4.3	KONFIGURATION – GERÄTEVERWALTUNG .....	42
5.2.4.4	KONFIGURATION – STANDARDEINSTELLUNGEN .....	44
5.2.5	RELAIS KONFIGURATION .....	44
5.2.6	MICROSD-KARTE.....	45
5.2.7	BILDSCHIRM SPERREN .....	45
5.2.8	GERÄTEINFORMATIONEN.....	45
5.2.9	ZEITEINSTELLUNG.....	45
5.2.10	GERÄT NEU STARTEN.....	46
5.2.11	PASSWORTEINSTELLUNGEN (PIN-CODE) .....	46
5.2.12	SYSTEMSPRACHE .....	47
5.2.13	HELLIGKEITSEINSTELLUNG .....	47
5.2.14	ETAGENTASTER.....	47
5.2.15	OPEN SOURCE LIZENZINFORMATIONEN .....	47
<b>6.</b>	<b>WARTUNG UND REINIGUNG.....</b>	<b>48</b>
6.1	FUNKTIONSTEST.....	48
6.2	REINIGUNG .....	48
<b>7.</b>	<b>ENTSORGUNG .....</b>	<b>48</b>
<b>8.</b>	<b>OPEN SOURCE LIZENZHINWEISE.....</b>	<b>49</b>



<b>9.</b>	<b>INSTALLATIONS- UND INBETRIEBNAHMEHINWEISE</b> .....	<b>50</b>
9.1	VERWENDUNG SICHERHEITSMODUL (TVHS10040/TVHS20340).....	50
9.2	EINRICHTUNG NEBENEINGÄNGE .....	52
9.3	EINRICHTUNG ERWEITERTER KLINGELTASTEN FÜR MEHRPARTEIEN-HAUS .....	54
9.4	LAUTSTÄRKE AM TÜR-VIDEOMODUL (TVHS20000(S), TVHS20010(S)) EINSTELLEN.....	58
9.5	ANSCHLUSS EINER VORHANDENEN HAUSTÜRKLINGEL .....	59
9.6	ANSCHLUSS VORHANDENER TÜRÖFFNER AN TÜRSTATIONS-MONITOR.....	60
9.7	ANSCHLUSS ETAGENKLINGELTASTER AN HAUPT-MONITOR .....	61
9.8	ANSCHLUSS ELEKTRISCHER TÜRÖFFNER AN VIDEO MODUL (INKL. „GARTENTOR“) .....	61
9.9	EINSPIELEN EIGENER KLINGELTÖNE IN DEN TÜRSTATIONS-MONITOR.....	63
9.10	ABUS CMS: FIRMWARE UPDATE DER MODUVIS-KOMPONENTEN DURCHFÜHREN .....	65
9.11	ABUS CMS: ERWEITERTE EINSTELLUNGSMÖGLICHKEITEN.....	67
9.12	FUNKTIONSUMFANG MODUVIS UND ABUS LINK STATION APP.....	70
9.13	KOMPATIBILITÄT MIT ABUS PRODUKTEN .....	71
9.14	EINBINDUNG VIDEO-TÜRMODUL IN ABUS NVR .....	71
9.15	“NOT-TÜR-ÖFFNER” TASTER AN TÜR-VIDEOMODUL .....	72
9.16	RELAISBESCHALTUNG.....	74
9.17	ANLEITUNG ZUM AUSMESSEN DES VORHANDENEN TÜRÖFFNERS.....	75
9.18	ANWENDUNGSBEISPIEL „VIDEOMODUL VOR JEDER WOHNUNGSTÜR“ .....	75
9.19	ANWENDUNGSBEISPIEL „INDIVIDUELLER WIFI ZUGRIFF“ .....	78
<b>10.</b>	<b>LEITFADEN ZUR VERDRAHTUNG (2-DRAHT)</b> .....	<b>79</b>

## 1. Bestimmungsgemäße Verwendung

Diese MODUVIS Türsprechanlage stellt eine Gegensprechanlage mit Videodarstellung des Türbereiches dar. Die Anlage kann für Ein- und Mehrfamilienhäuser verwendet werden. Durch Erweiterungsmonitore in einer Wohneinheit kann die Anlage ebenfalls als Gegensprechanlage (ohne Video) innerhalb der Wohneinheit dienen.

Die MODUVIS Türsprechanlage stellt keine Videoüberwachungsanlage dar und darf auch nicht als eine solche Anlage verwendet werden.



Eine andere Verwendung als oben beschrieben kann zur Beschädigung des Produkts führen, außerdem bestehen weitere Gefahren. Jeder andere Einsatz ist nicht bestimmungsgemäß und führt zum Verlust der Garantie bzw. Gewährleistung; sämtliche Haftung wird ausgeschlossen. Dies gilt auch, wenn Umbauten und/oder Veränderungen am Produkt vorgenommen wurden. Lesen Sie sich die Bedienungsanleitung vollständig und aufmerksam durch, bevor Sie das Produkt in Betrieb nehmen. Die Bedienungsanleitung enthält wichtige Informationen für Montage und Bedienung.

## 2. Symbolerklärung



Das Symbol mit dem Blitz im Dreieck wird verwendet, wenn Gefahr für die Gesundheit besteht, z. B. durch elektrischen Schlag.



Ein im Dreieck befindliches Ausrufezeichen weist auf wichtige Hinweise in dieser Bedienungsanleitung hin, die unbedingt zu beachten sind.



Dieses Symbol ist zu finden, wenn Ihnen besondere Tipps und Hinweise zur Bedienung gegeben werden sollen.

### 3. Systemübersicht

Diese Türsprechanlage ist mit zwei verschiedenen Verdrahtungstechnologien erhältlich:

**2-Draht Variante:** Die Kommunikation und die Spannungsversorgung erfolgen über 2 Drähte (1 Paar). Die Verdrahtung erfolgt sternförmig, den zentralen Punkt stellt ein 2-Draht Verteiler dar.  
Ein Grundsystem besteht aus 2-Draht Verteiler, 2-Draht Monitor sowie 2-Draht Videomodul.

**IP Variante:** Die Kommunikation und die Spannungsversorgung erfolgt über Ethernet-(Netzwerk)-Kabel. Die Komponenten unterstützen Power-over-Ethernet (PoE) (optional 12 VDC) Die Verkabelung erfolgt sternförmig, den zentralen Punkt stellt der (PoE)-Switch dar.  
Ein Grundsystem besteht aus IP-Monitor und IP-Videomodul.

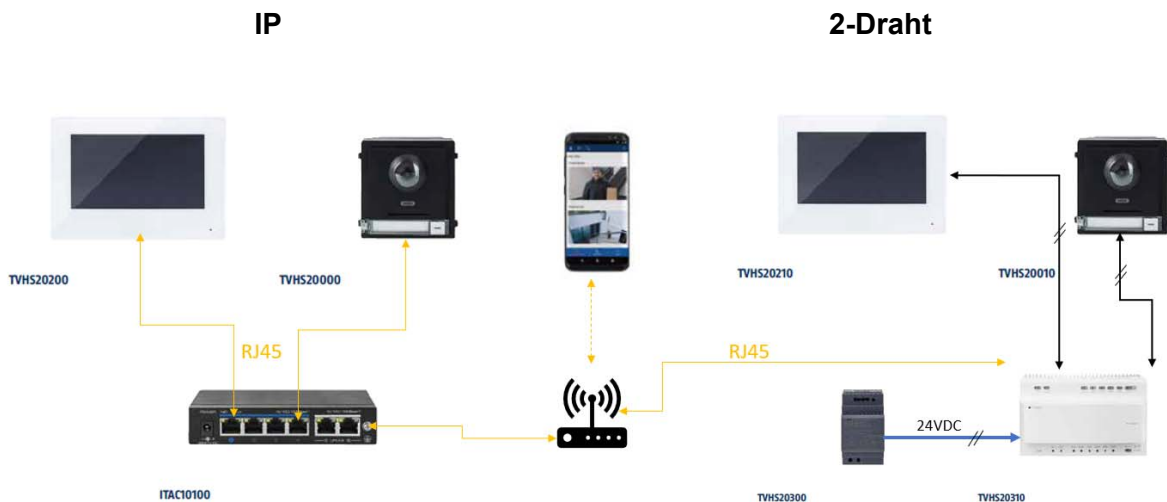

**i** Beide Systemvarianten können im Mischbetrieb verwendet werden. Dies erlaubt eine optimale Anpassung an die baulich vorhandenen Gegebenheiten.

### Beispiele für Mischbetriebe:

Dieses Beispiel zeigt den Mischbetrieb eines Hauptmonitors per 2-Draht und eines Erweiterungsmonitors per WiFi.

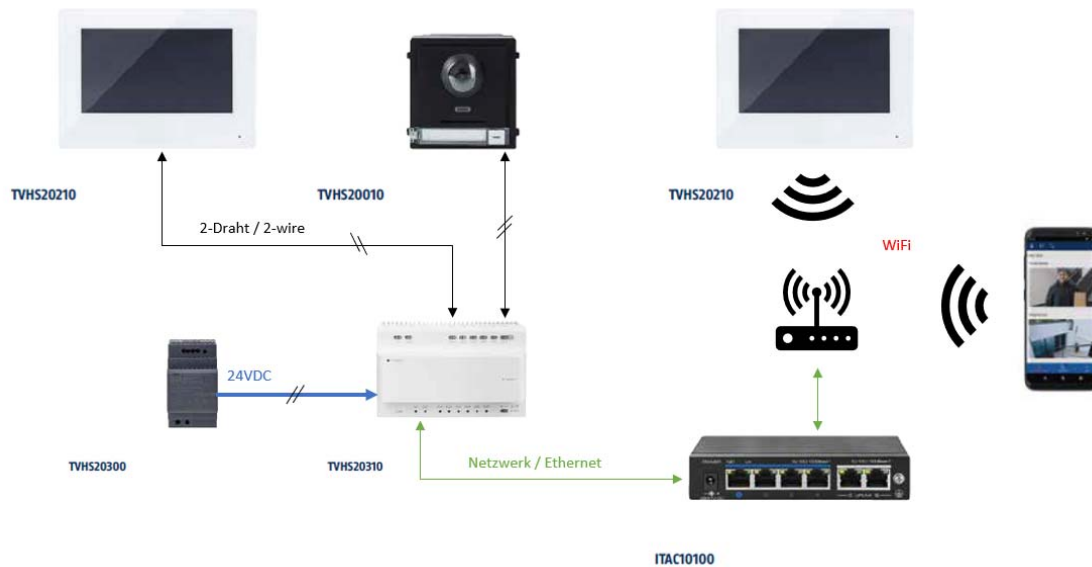



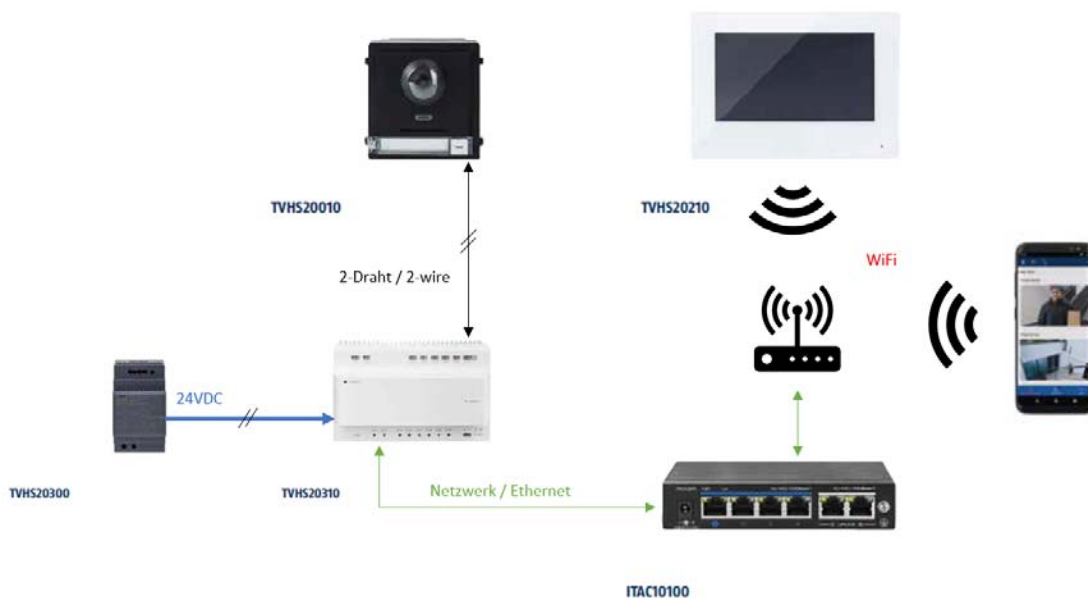



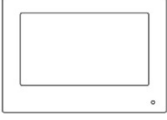

Dieses Beispiel zeigt den Mischbetrieb eines Videotürmoduls per 2-Draht mit einem Hauptmonitor per WiFi.



### 3.1 2-Draht Variante

#### 3.1.1 Komponenten

<p>TVHS20210</p>  <p>2-Draht Monitor</p>	<p>TVHS20010 / TVHS20010S</p>  <p>2-Draht Videomodul</p>	<p>TVHS20310</p>  <p>2-Draht Verteiler</p>
<p>TVHS20020 / TVHS20020S</p>  <p>Klingeltastenmodul (6-Tasten)</p>	<p>TVHS20030 / TVHS20030S</p>  <p>Nummerntastatur</p>	<p>TVHS20040</p>  <p>Infomodul</p>
<p>TVHS20300</p>  <p>24 VDC Netzteil für Hutschiene</p>	<p>TVHS10040 / TVHS20340</p>  <p>Sicherheitsmodul</p>	

### 3.1.2 Empfohlene Kabeltypen

Wählen Sie den Kabeltyp entsprechend dem Abstand zwischen Videomodul, Verteiler und Monitor aus.

2-Draht Videomodul (TVHS20010/TVHS20010S)







2-Draht Monitor (TVHS20210)

2-Draht Verteiler (TVHS20310)

Kabeltyp	24AWG (10 Ω pro 100m)	20AWG (7 Ω pro 100m)	18AWG (4 Ω pro 100m)
<b>Kabelweg</b>			
TVHS20310 / TVHS20310	Max. 60 m	Max. 60 m	Max. 60 m
TVHS20010(S) / TVHS20310	Max. 35 m	Max. 60 m	Max. 60 m
TVHS20210 / TVHS20310	Max. 35 m	Max. 60 m	Max. 60 m









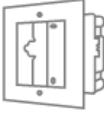
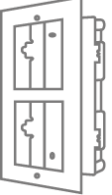

### 3.2 IP Netzwerk Variante

#### 3.2.1 Komponenten

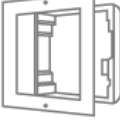
TVHS20200 / TVHS20220  IP 7" / 10" PoE Monitor	TVHS20000 / TVHS20000S  IP Videomodul	TVHS20020 / TVHS20020S  Klingeltastenmodul (6-Tasten)
TVHS20030 / TVHS20030S  Nummerntastatur	TVHS20040  Infomodul	TVHS10040 / TVHS20340  Sicherheitsmodul

### 3.3 Installationskomponenten

Diese verfügbaren Installationskomponenten können für die 2-Draht sowie die IP-Variante der Moduvis Video-Türsprechanlage verwendet werden

<p>TVHS20050</p>  <p>Leermodul Blende</p>	<p>TVHS20060</p>  <p>Blende für ungenutzte Klingeltaste</p>	<p>TVHS20100(S)</p>  <p>Rahmen für 1 Modul Unterputzmontage</p>
<p>TVHS20110(S)</p>  <p>Rahmen für 2 Module Unterputzmontage</p>	<p>TVHS20120(S)</p>  <p>Rahmen für 3 Module Unterputzmontage</p>	<p>TVHS10130(S)</p>  <p>Rahmen für 1 Modul Aufputzmontage</p>
<p>TVHS10140(S)</p>  <p>Rahmen für 2 Module Aufputzmontage</p>	<p>TVHS10150(S)</p>  <p>Rahmen für 3 Module Aufputzmontage</p>	<p>TVHS20160</p>  <p>Außengehäuse für Rahmen Aufputzmontage (1 Modul)</p>
<p>TVHS20170</p>  <p>Außengehäuse für Rahmen Aufputzmontage (2 Module)</p>	<p>TVHS20180</p>  <p>Außengehäuse für Rahmen Aufputzmontage (3 Module)</p>	

### 3.4 Systemvarianten

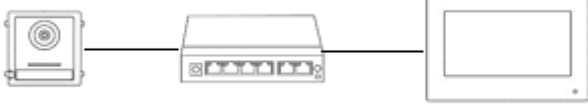
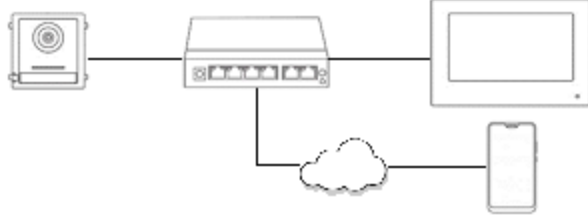
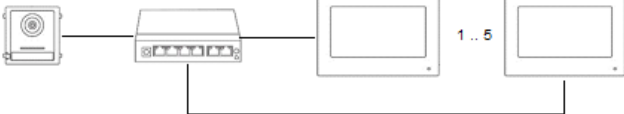
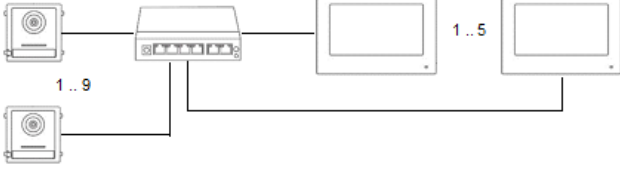
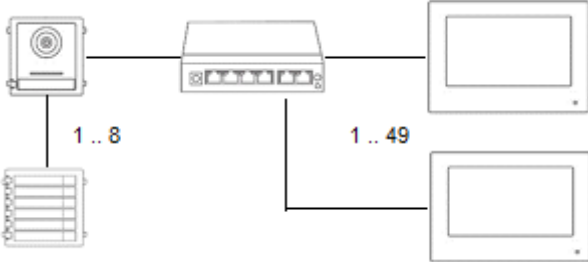
#	Technologie / Verdrahtung	Systemaufbau	Anwendungs- beispiel
1	IP		Einfamilienhaus
2	IP		Einfamilienhaus mit App-Zugriff
3	IP		Einfamilienhaus mit Innenerweiterungs- monitoren
4	IP		Einfamilienhaus mit Innenerweiterungs- monitoren und Nebeneingängen
5	IP		Mehrfamilienhaus



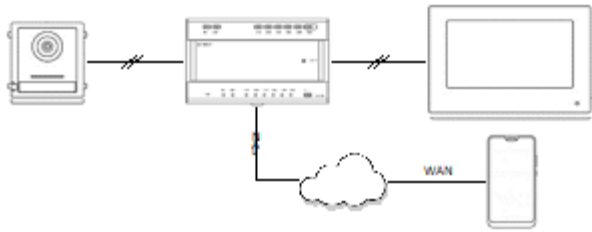
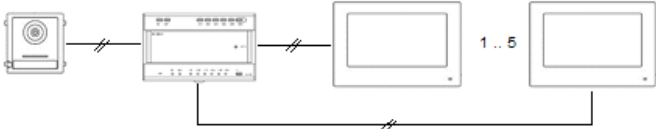
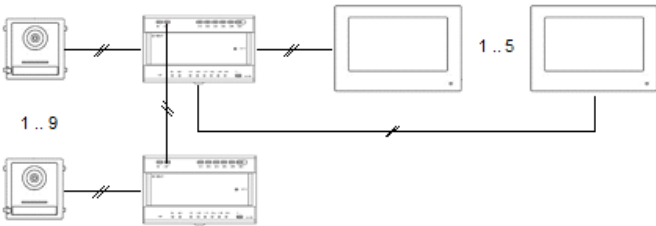
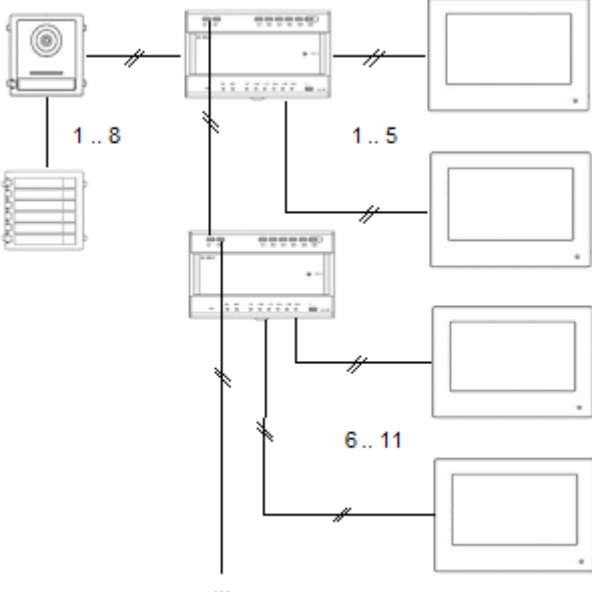

6	IP	<p>Diagram 6 shows a central hub connected to 8 cameras (1..8) and 4 monitors (1..5, 1..5).</p>	<b>Mehrfamilienhaus mit Innenerweiterungs- monitoren</b>
7	IP	<p>Diagram 7 shows a central hub connected to 7 cameras (1..7), 4 monitors (1..5, 1..5), and a keypad.</p>	<b>Mehrfamilienhaus mit Innenerweiterungs- monitoren und Nummertastatur- Modul</b>
8	IP	<p>Diagram 8 shows a central hub connected to 6 cameras (1..6), 4 monitors (1..5, 1..5), a keypad, and an info module.</p>	<b>Mehrfamilienhaus mit Innenerweiterungs- monitoren, Nummertastatur- Modul und beleuchtetes Info- Modul</b>
9	2-Draht	<p>Diagram 9 shows a camera connected to a monitor via a 2-wire line.</p>	<b>Einfamilienhaus</b>
10	2-Draht	<p>Diagram 10 shows two cameras connected to a monitor via a 2-wire line.</p>	<b>Einfamilienhaus mit Nebeneingang</b>

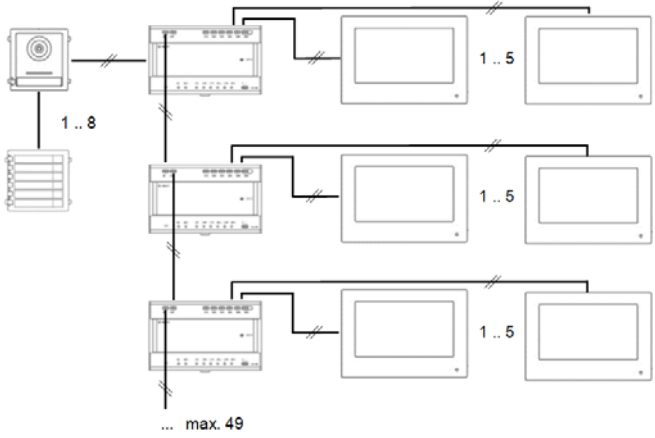
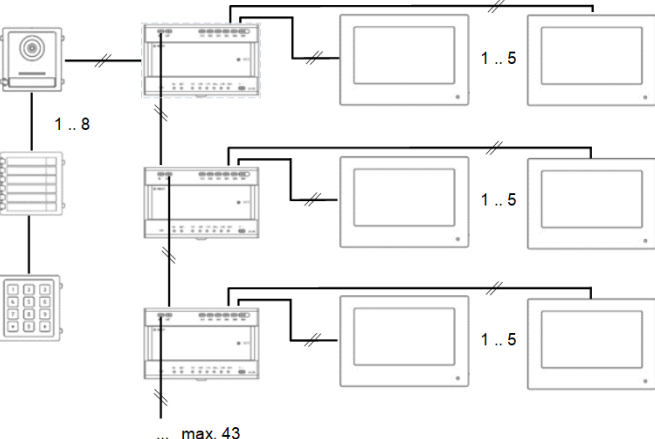
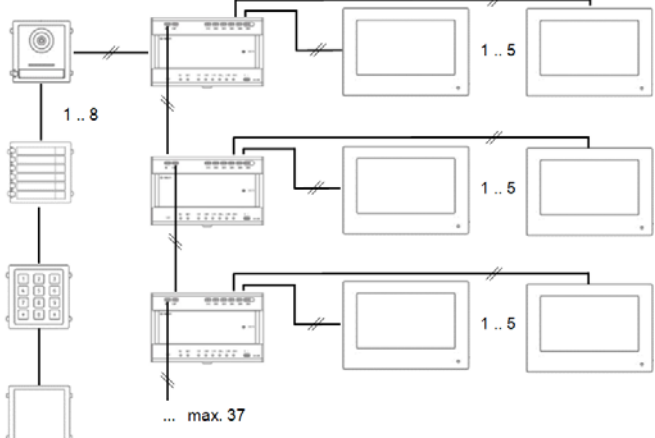
11	2-Draht		<b>Einfamilienhaus mit App-Zugriff</b>
12	2-Draht		<b>Einfamilienhaus mit Innenerweiterungs- monitoren</b>
13	2-Draht		<b>Einfamilienhaus mit Innenerweiterungs- monitoren und Nebeneingängen</b>
14	2-Draht		<b>Mehrfamilienhaus</b>

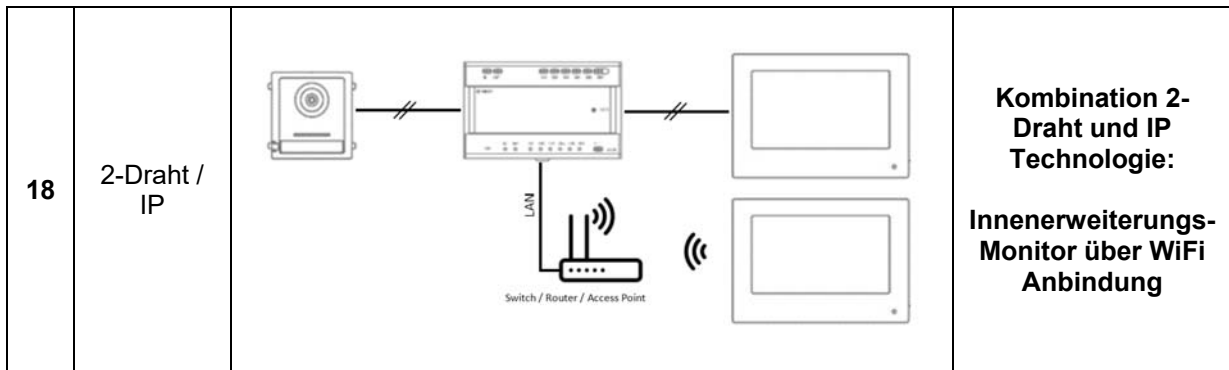
15	2-Draht	 <p>... max. 49</p>	<b>Mehrfamilienhaus mit Innenerweiterungs- monitoren</b>
16	2-Draht	 <p>... max. 43</p>	<b>Mehrfamilienhaus mit Innenerweiterungs- monitoren und Nummertastatur- Modul</b>
17	2-Draht	 <p>... max. 37</p>	<b>Mehrfamilienhaus mit Innenerweiterungs- monitoren, Nummertastatur- Modul und beleuchtetes Info- Modul</b>



	<p><b>HINWEIS:</b></p> <p>Jeder Monitor und jedes Tür-Videomodul erscheint eigenständig im Netzwerk und verfügt über eine eigene IP-Adresse. Hierbei spielt es keine Rolle, ob die Systeme via PoE-Netzwerk oder bei der 2-Draht Variante an den „2-Draht-Verteiler“ angeschlossen sind. Die Monitore „TVHS20200“ und TVHS20220 können zudem via W-LAN in die Netzwerkstruktur eingebunden werden.</p>
---	--

	<p><b>HINWEIS:</b></p> <p>Jedes Endgerät muss direkt mit der Verteilereinheit verbunden werden. Eine Weiterleitung von einem Monitor zum nächsten Monitor ist nicht zulässig.</p>
---	---

## **4. Inbetriebnahme**

### **4.1 *Installation und Verdrahtung***

Detaillierte Verdrahtungshinweise entnehmen Sie bitte den Produkten beiliegenden Kurzanleitungen. Die Kurzanleitungen sind ebenfalls über die Produktsuche auf [www.abus-sc.de](http://www.abus-sc.de) zu finden.

#### **Installationshöhe**

Die Installationshöhe des Videomoduls TVHS20000(S) bzw. TVHS20010(S) sollte 1,40 Meter nicht wesentlich unterschreiten oder überschreiten. Sonst kann es passieren, dass Personen die zu nah am Videomodul stehen nicht über das Gesicht erkannt werden können.

## 4.2 Aktivierungsmöglichkeiten / Erstkennwortvergabe

### 4.2.1 Aktivierung über Türstationsmonitor

- 1) Stellen Sie die Spannungsversorgung des Systemes her und stellen Sie sicher, dass die Türstation sich ebenfalls im gleichen Netzwerk befindet.

Vergeben Sie ein Passwort bei der Ersteinrichtung des Monitors. Dieses Passwort wird ebenfalls automatisch für die Aktivierung der Türstation verwendet. Ebenso wird das Passwort für den passwortgeschützten Bereich des Monitors benötigt.

- 8-16 Zeichen
- ültige Zeichen: Zahlen, Kleinbuchstaben, Großbuchstaben, Sonderzeichen ( ! \$ % & / ( ) = ? + - )
- 2 verschiedene Arten von Zeichen müssen verwendet werden

- 2) Wählen Sie die gewünschte Sprache aus und bestätigen mit der „WEITER“ Taste.

	Assistent Sprache 1/4
English	
Deutsch	
Italiano	
Francais	
Niederländisch	

	<b>Firmware-Versionshinweis</b>
Funktion: Niederländische Sprache	
Videomodul (THVS20000(S)/TVHS20010(S)): V2.2.3_build_201029	
Monitor (TVHS20200/210/220): V2.1.2_build_201029	



- 3) Wählen Sie nun zwischen DHCP / Fixer IP Adresse aus. Es wird dringend empfohlen jedem eigenständigen Gerät eine fixe IP Adresse zuzuteilen, da ansonsten bei einem Stromausfall unter Umständen neue IP Adressen zugewiesen werden und es zu ernsthaften Störungen im System kommen kann.

	Assistent-Netzwerk 2/4
DHCP	<input type="checkbox"/>

Lokale IP	192.168.0.11
Subnetzmaske	255.255.255.0
Gateway	192.168.0.1

	<p><b>Hinweis</b></p> <p>Beim Betätigen des Schalters für die DHCP Funktion springt der Schalter erst nach rechts und dann wieder nach links. In diesem Moment wird eine IP Adresse vom DHCP Server bezogen, welche dann als feste IP Adresse im Gerät eingestellt wird.</p>
---	--

4) Wählen Sie den Typ des Monitors aus welchen Sie einrichten möchten.

	Assistent-Netzwerk 3/4	
Innenstation Typ	Innenstation	
Etage	0	
Apartmentnr.	1	

**Innenstation:**

**Dieser Monitor stellt den Hauptmonitor der Türsprechanlage in einer Wohnung dar.** Hier spielt es keine Rolle ob ein Einfamilienhaus oder ein Mehrparteienhaus eingerichtet wird. Der Hauptmonitor einer Wohnung muss immer mit dem Typ „Innenstation“ eingerichtet werden. Wenn Sie nur eine Klingeltaste und eine Wohnung verwenden, bleibt die Apartmentnummer auf „1“ stehen. Sobald mehrere Wohnungen / Hauptmonitore verwendet werden, muss die Apartmentnummer angepasst werden.

Beispiel: Wohnung 1 => Apartmentnummer 1  
Wohnung 2 => Apartmentnummer 2  
(etc...)

Nur so können die Klingeltaster den verschiedenen Parteien zugewiesen werden.

**Hinweis:** Ein Hauptmonitor (Innenstation) muss immer mit der Haupt-Türstation im System verlinkt werden.

**Innenerweiterung:**

Der Monitor wird als Erweiterungsmonitor in einem System eingesetzt um weitere Zimmer in einem Haus auszustatten. Sämtliche Erweiterungsmonitore werden mit dem Hauptmonitor verknüpft und zeigen bei einem Klingelruf die gleichen Funktionen wie der Hauptmonitor.



Sie können maximal 5 Zusatzmonitore an einen Hauptmonitor knüpfen. (Nr. 1-5).  
 Zudem kann der „Raumname“ vergeben werden. Dieser erscheint automatisch unter „Kontakte“ in den anderen Monitoren im System.

**Hinweis:** Ein Erweiterungsmonitor (Innenerweiterung) muss immer mit dem Haupt-Monitor im System verlinkt werden!

Beim Installationstyp „Innenerweiterung“ stehen am Monitor folgende Menüpunkte nicht zur Verfügung. **Diese sind nur am Hauptmonitor des Systems einstellbar/abrufbar:**

- „Automatische Annahme“ des Anrufbeantworters an/ausschalten.
- Anrufbeantworter Nachrichten abhören
- ABUS LINK Station App – Menü
- Netzwerkkameras hinzufügen
- Konfiguration der Netzwerk-Adresse und setzen von Werkseinstellungen auf Endgeräten

5) „Assistent-Verbundene Geräte“

<span style="font-size: 2em; color: blue;">&lt;</span> <span style="margin-left: 100px;">Assistent Verbundene Geräte</span>				
Nach Seriennummer suchen				
ABUS Artikelnummer	IP-Adresse	Firmwareversion	Aktivieren	
				
ABUS Artikelnummer	IP-Adresse	Firmwareversion	Aktivieren	
				
ABUS Artikelnummer	IP-Adresse	Firmwareversion	Aktivieren	
				

Hier sehen Sie die verfügbaren Netzwerkgeräte der TVHS20xxx Türstations-Serie.

Im Falle einer Einrichtung eines Hauptmonitors muss hier die Haupttürstation ausgewählt werden.

Im Falle einer Einrichtung einer Innenerweiterung muss hier der Hauptmonitor ausgewählt werden.

Sie haben hier die Möglichkeit die Türstation ebenfalls zu „Aktivieren“. Der Hauptmonitor aktiviert dann automatisch die Türstation mit dem gleichen Passwort des Monitors.

Wählen Sie hierfür die Haupttürstation in der Liste aus und klicken auf „Aktivieren“. Nach erfolgreicher Aktivierung wählen Sie bitte die Türstation aus. Es erscheint ein grüner Bestätigungshaken an der linken Seite der Liste. Die Türstation ist nun aktiviert und erfolgreich verknüpft.



Sollte kein Gerät im Netzwerk gefunden werden, stellen Sie sicher, dass die Türstation sich im gleichen Netzwerk befindet und mit Strom versorgt wurde.

Mit dem jeweiligen „Zahnrad“ werden die IP-Einstellungen der Geräte geöffnet. So kann die IP Adresse des Tür-Videomoduls angepasst werden.

Möchten Sie neben einer Türe weitere Nebeneingänge hinzufügen, wechseln Sie bitte zu Kapitel „9.2 Einrichtung Nebeneingänge“ unter Installations- und Inbetriebnahmehinweise.

#### **4.2.2 Aktivierung über IP Netzwerk**

Installieren und starten Sie den ABUS IP Installer, welcher über die ABUS Web-Seite [www.abus.com](http://www.abus.com) beim jeweiligen Produkt verfügbar ist.

Jedes verbundene Gerät sollte nun in der Auswahlliste erscheinen, ggf. noch mit nicht zu dem Zielnetzwerk passender IP Adresse.

Als erstes muss jedes Gerät aktiviert werden, d.h. es muss ein entsprechend sicheres Passwort für den Hauptbenutzer „admin“ vergeben werden. Ein sicheres Kennwort muss mindestens folgende Anforderungen erfüllen:

- 8-16 Zeichen
- Gültige Zeichen: Zahlen, Kleinbuchstaben, Großbuchstaben, Sonderzeichen ( ! \$ % & / ( ) = ? + - )
- 2 verschiedene Arten von Zeichen müssen verwendet werden

Die IP-Einstellungen der Kamera können über den IP Installer geändert werden.

Die Schaltfläche „Browser“ steht bei den Komponenten der Türsprechanlage nicht zur Verfügung, da diese über keinen eigenen Webserver verfügen.

Die Programmierung der Komponenten kann weitestgehend über den Monitor der Türsprechanlage vorgenommen werden. Für komplexere Systemaufbauten ist jedoch eine Programmierung über die CMS Software nötig (Einbindung einer Komponente wie ein IP Gerät, Öffnen des Menüpunktes „Fern-Konfiguration“).





	<p>Die Aktivierung im IP Netzwerk kann ebenfalls über die ABUS CMS Software erfolgend.</p> <p>Für bestimmte weiterführende Einrichtungsschritte ist die ABUS CMS Software gegebenenfalls nötig.</p>
---	---

#### **4.2.3 Passwort-Reset Monitor/Video-Türmodul**

Für ein Rücksetzen des Passwortes von Monitor oder Video-Türmodul setzen Sie sich bitte mit unserem Technischen Support in Verbindung.

## 5. Bedienung des Monitors (2-Draht & IP)

### 5.1 Livebild

Schaltfläche / Anzeige	Beschreibung
	Nimmt den Anruf an und öffnet die Video/Sprachverbindung.
	Beendet einen Anruf und legt auf.
	Speichert einen Sofort-Schnappschuss des aktuellen Videobildes
	<p>Öffnet die Tür. Werden mehrere Relais-Ausgänge zeitgleich verwendet, gibt es bis zu 3 Schlüsselsymbole. (2x Tür-Relais im Tür- Videomodul, 1x Tür-Relais im Monitor).</p> <p>Hilfe zum Anschluss eines Türöffners an das Relais oder zur Verwendung des Sicherheitsmoduls TVHS10040/TVHS20340 finden Sie im Abschnitt <u>Installations- und Inbetriebnahmehinweise</u> im Kapitel „9.8 Anschluss elektrischer Türöffner an Video Modul (inkl. „Gartentor“)" und „9.1 Verwendung Sicherheitsmodul (TVHS10040/TVHS20340)“</p>

## 5.2 Hauptseite Übersicht

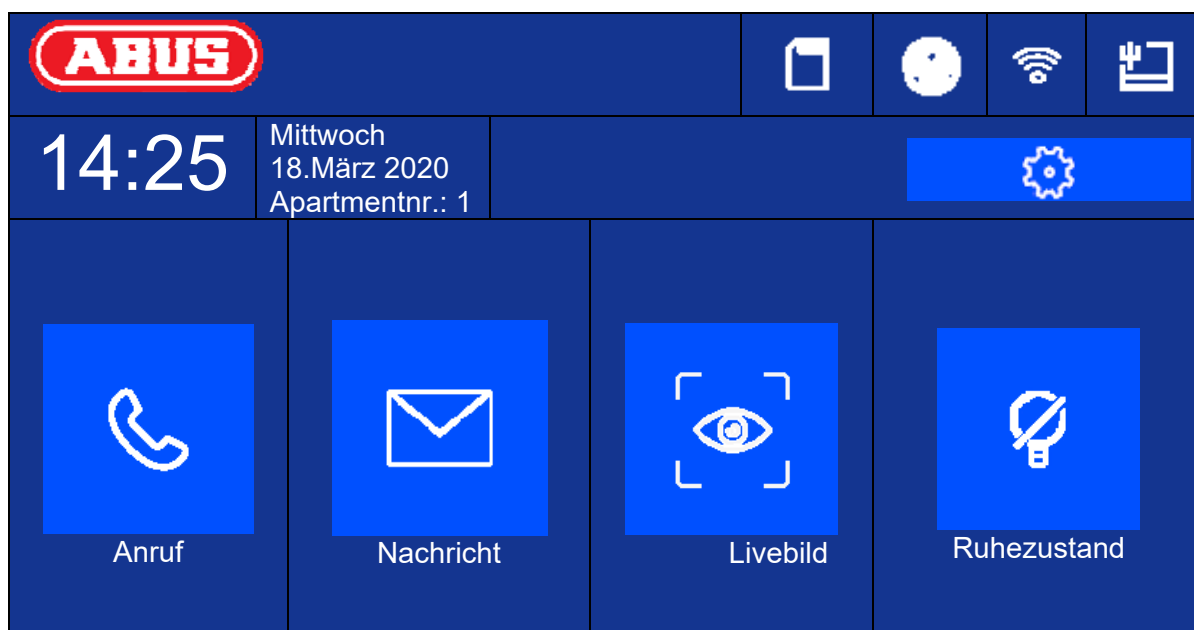









Schaltfläche / Anzeige	Beschreibung
Uhrzeit	Anzeige der Uhrzeit  Durch einmaliges Tippen auf das Anzeigefeld wird der Dialog zum Einstellen von Datum und Uhrzeit geöffnet.
Wochentag / Datum	Anzeige des aktuellen Wochentages Anzeige des Datums
Apartmentnummer	Anzeige der konfigurierten Apartmentnummer dieser Innenstation. Max. 49 Apartments pro System möglich.
[ Anruf ]	Gegensprechen zu Innenstation bzw. Innenerweiterung aufbauen.  Kontakte anzeigen / verwalten  Anrufprotokoll einsehen (inkl. Informationen über Klingelstation, Einzelbild, Datum, Uhrzeit)
[ Nachricht ]	Informationen über Hinweise, Besuchermittelungen und Einzelbilder der Rufannahme
[ Livebild ]	Livebild von angeschlossenen Türstationen sowie konfigurierten Netzwerkkameras anzeigen
[ Einstellungen / Zahnrad ]	Generelle Anrufeinstellungen: Klingelton, Klingeldauer, Anrufdauer, Anrufumleitung, Mikrofonlautstärke, Klingellautstärke, Gesprächslautstärke, Tastenton, Auto-Annahme, Nicht-Stören-Modus  WLAN-Einstellungen für den Monitor (nur bei

	IP Variante zu verwenden!)  Weitere Geräteeinstellungen: Konfiguration (System), Relaisverhalten, microSD Karte, Uhrzeit, Bildschirmhelligkeit,
[ Ruhezustand ]	Bildschirm sofort deaktivieren







## Anruf

Anrufe zwischen Apartments oder Erweiterungsmonitoren starten. Ebenso können hier Kontakte angelegt werden. Eine Innenerweiterung wird automatisch angelegt.

	*Rufnummer eingeben (0-0 für Innenstation,0-1 Innenstation Erweiterung Nr.1)				
					
					
					



















## Kontaktliste

Hier können Sie angelegte Kontakte bearbeiten oder löschen. Zum Löschen für 3 Sekunden auf die Kontakt-Zeile drücken. Daraufhin erscheint ein Menü zum Löschen von Kontakten.





	Kontaktliste		
Room 1			
			
			

## Anrufprotokoll

Zeigt die eingegangenen Anrufe / Klingelrufe an. Zusätzlich kann direkt auf einen Schnappschuss zugegriffen werden.







	Anrufprotokoll			
	Haupt-Türstation		14-03-2020 11:21:08	
	Haupt-Türstation		14-03-2020 10:55:37	
	Haupt-Türstation		14-03-2020 10:55:37	
	Haupt-Türstation		14-03-2020 10:55:37	
	Haupt-Türstation		14-03-2020 10:55:37	
	Haupt-Türstation		14-03-2020 10:55:37	
	Haupt-Türstation		14-03-2020 09:55:37	

## Hinweis

	Hinweis		
Kein Hinweis		...	
			
			













### Besuchermittellung (Anrufbeantworter)

Hier können, falls vorhanden und aktiviert, die Audio-Mitteilungen des Anrufbeantworters abgehört werden.















<		Besuchermittellung		  
Nr.1			14-03-2020 10:47:35	
Nr.2			13-03-2020 14:47:39	
Nr.3			13-03-2020 14:26:06	

### Aufnahmeprotokolle

Hier finden Sie eine Übersicht der Bilder sortiert nach Tagen

<		Aufnahmeprotokolle			  
14-03					
					
					
					

### 5.2.1 Menüpunkt: Anrufeinstellungen

<	Anrufeinstellungen				
Klingelton	Klingelton 6	>			
Klingelton aktivieren	<input type="checkbox"/>				
Klingeltondauer		30 s			
Anrufdauer		30 s			
Anrufumleitung		0 s			
Mikrofonlautstärke		10%			
Klingeltonlautstärke (Monitor)		70%			
Gesprächslautstärke		10%			
Tippton	<input type="checkbox"/>				
Automatische Annahme	<input type="checkbox"/>				
Sofortige Automatische Annahme	<input type="checkbox"/>				
Nicht-Stören-Modus	Innenstation	>			
Nicht Stören	Ganztägig	>			

Schaltfläche / Anzeige	Beschreibung
Klingelton (1~6):	Wählen sie zwischen den 6 Standard-Klingeltönen aus.
Klingelton aktivieren:	Hier können Sie den Klingelton aktivieren oder stummschalten.
Klingeltondauer (1~60s):	Legt die Klingeltondauer bei einem eingehenden Anruf fest. Nach der festgesetzten Zeit wird der Klingelton automatisch stummgeschaltet. Der Anruf bleibt weiterhin aktiv.
Anrufdauer (1~60s):	Legt die Anrufdauer fest. Nach der eingestellten Zeit wird der eingehende Anruf automatisch beendet.



Anrufumleitung (0~20s):	Die Anrufumleitung verzögert das Anrufen der ABUS Link Station App. Beispiel: 10 Sekunden. Nach einem Klingelanruf klingelt der Monitor der Türstation sofort aber die ABUS LINK Station wird mit einer Verzögerung von 10 Sekunden angerufen.
Mikrofonlautstärke (0~100%):	Stellen Sie hier die Mikrofonlautstärke des Monitors ein. Je mehr Prozent desto lauter (empfindlicher) ist das Mikrofon am Monitor.
Klingeltonlautstärke (Monitor) (0~100%):	Stellen Sie hier die Klingeltonlautstärke vom Monitor ein.
Gesprächslautstärke (10~100%):	Stellen Sie hier die gewünschte Gesprächslautstärke am Monitor ein
Tipton:	Aktiviert den Tastenton beim Tippen auf dem Touch-Screen des Monitors.
Automatische Annahme	Bei aktivierter Funktion nimmt die Türsprechanlage nach Ablauf des Klingelrufs (Klingeltondauer) den Anruf mit dem Anrufbeantworter an.
Sofortige Automatische Annahme	Bei aktivierter Funktion nimmt die Türsprechanlage beim Klingeln den Anruf sofort automatisch mit dem Anrufbeantworter an.  Bei deaktivierter Funktion wird der Anrufbeantworter den Anruf nach der eingestellten Anrufdauer automatisch annehmen.
Nicht-Stören-Modus:	Innenstation: Anrufe von Türstationen und Erweiterungsmonitoren erlaubt. Nicht zugelassen werden Anrufe von fremden Apartments. Um Anrufe aus Apartments zuzulassen bitte die Funktion „Nicht Stören“ auf „Deaktiviert“ setzen.  Alle: Es werden alle Anrufe abgelehnt. (Anrufe von Türstation, Erweiterungsmonitor oder anderes Apartment)
Nicht stören:	Deaktiviert, Ganztägig, Zeitplan (täglich von-bis Stunde/Minute). Legt fest, in welchem Zeitraum die „Nicht stören“ Funktion aktiv ist.

	<b>Firmware-Versionshinweis</b>
	<p>Funktion: Automatische Annahme, Sofortige Automatische Annahme</p> <p>Videomodul (THVS20000(S)/TVHS20010(S)): V2.2.3_build_201029</p> <p>Monitor (TVHS20200/210/220): V2.1.2_build_201029</p>







Möchten Sie eine (bereits vorhandene) Hausklingel / Türgong weiterverwenden, wechseln Sie zum Kapitel „9.5 Anschluss einer vorhandenen Haustürklingel“ im Abschnitt Installations- und Inbetriebnahmehinweise.

Für Informationem zum Ändern der Lautstärke vom Video-Türmodul wechseln Sie zum Kapitel „

#### 9.4 Lautstärke am Tür-Videomodul (TVHS20000(S), TVHS20010(S)) einstellen“.

Um eigene Klingeltöne in die Monitore einzuspielen, wechseln Sie zum Kapitel „9.9 Einspielen eigener Klingeltöne in den Türstations-Monitor“.

#### 5.2.2 WLAN Einstellungen

	Wlan-Einstellungen	
		
MAX_MUSTERWLAN		
		

Schaltfläche / Anzeige	Beschreibung
Aktivieren/Deaktivieren	Aktivieren/Deaktivieren Sie die WLAN Schnittstelle des Monitors
WLAN Netzwerkliste	Hier finden Sie verfügbare WLAN Netzwerke in Ihrer Umgebung. Durch Anwählen eines Eintrages werden Sie zur Eingabe des WLAN Passwortes aufgefordert. Nach erfolgreicher Verbindung erscheint in der Liste vor dem ausgewählten Netzwerk ein grüner Bestätigungshaken.
WLAN Info Icon	Hier sehen Sie die WLAN Parameter wie Netzwerkname, Signalpegel und IP-Parameter.  Wenn Sie auf „TRENNEN“ klicken, wird der Monitor vom WLAN getrennt.

### 5.2.3 Etagentaster

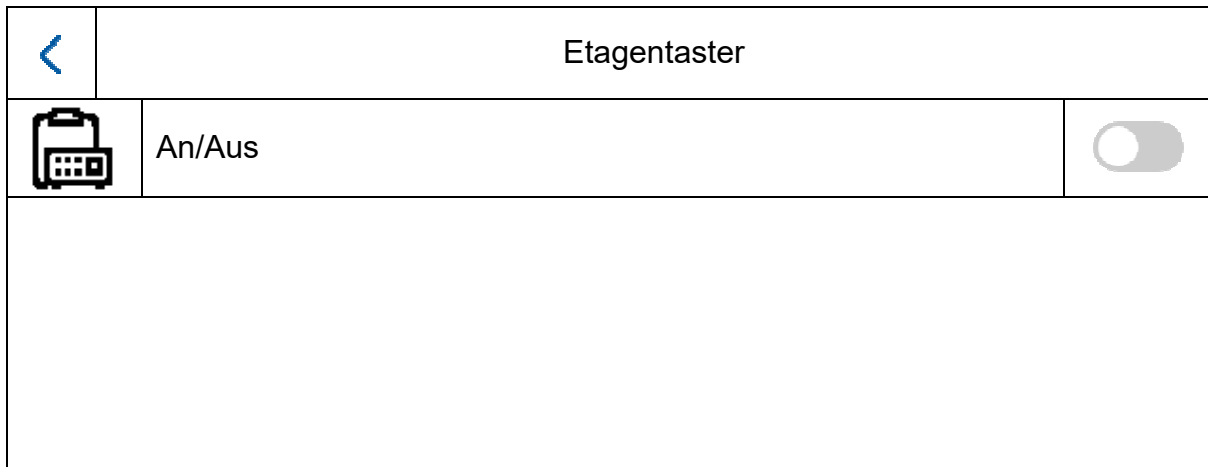











Der Etagentaster wird über die verdrahteten Eingänge direkt am Monitor angeschlossen und realisiert eine direkte Klingel an der Wohnungstür. Diese Funktion findet überwiegend in Mehrparteien-Häuser Verwendung. Hier ist die Haupttürstation unten am Haupteingang verbaut. Jede Wohnung hat aber noch ein direkten Klingeltaster an der Wohnungstür. Der Klingelton vom Etagen-Taster unterscheidet sich zum normalen Klingelton vom Video-Türmodul.

Schaltfläche / Anzeige	Beschreibung
Linie 1 – Linie 8	Beschreibt welcher Eingang am Monitor für den Etagentaster verwendet wird. In der Regel wird Eingang 1 (Linie 1) verwendet.
NO / NC	Normally Open / Normally Closed. Hier wird festgelegt ob der Klingeltaster der Wohnungstür ein Öffner- oder Schließerkontakt ist. In der Regel ist es ein „NO“ Kontaktschalter.

Weitere Informationen finden Sie im Abschnitt Installations- und Inbetriebnahmehinweise im Kapitel „9.7 Anschluss Etagen Klingeltaster an Haupt-Monitor“.

## 5.2.4 Sonstige Einstellungen

### 5.2.4.1 Konfiguration – Lokale Informationen

	Lokale Informationen			
Apartmentnr.			1	
Livebilddauer		30 s		
Einstellungen ABUS Link Station-Dienst				
Zeit synchronisieren				
Sommerzeit				
Assistent				

Dieser Bereich ist Passwort-geschützt. Geben Sie bitte das Passwort der Ersteinrichtung ein.

**Hinweis:** Beim Installationstyp „Innenerweiterung“ stehen am Monitor folgende Menüpunkte nicht zur Verfügung. **Diese sind nur am Hauptmonitor des Systems einstellbar/abrufbar:**

- „Automatische Annahme“ des Anrufbeantworters an/ausschalten.
- Anrufbeantworter Nachrichten abhören
- ABUS LINK Station App – Menü
- Netzwerkkameras hinzufügen
- Konfiguration der Netzwerk-Adresse und setzen von Werkseinstellungen auf Endgeräten

Installationstyp:                      Auswahlmöglichkeiten: Innenstation, Innenerweiterung

**Innenstation:** Hauptmonitor des Türsprechsystems innerhalb einer Wohnung/Apartment

**Innenerweiterung:** max. 5 weitere Monitor können innerhalb einer Wohnung/Apartment verbunden werden

Beispiel: Videomodul + Hauptmonitor + 5 Innenerweiterungen

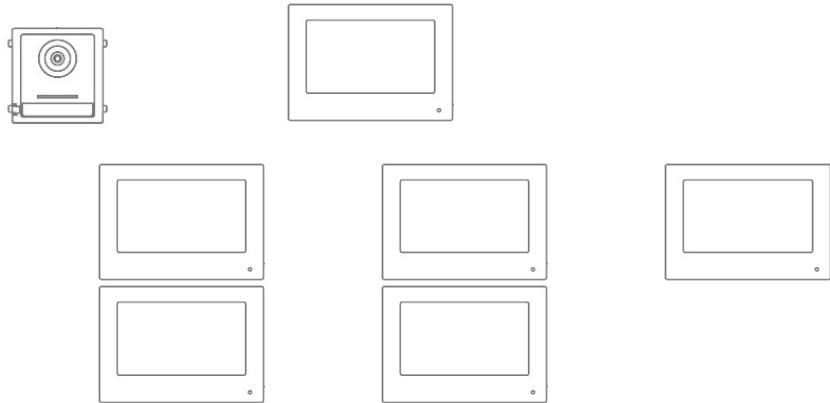

Apartmentnr.: Diese ist die maximale Anzahl von Innenstations-Monitoren welche über ein Tür-Videomodul mit 8 Klingeltastenerweiterungen verbunden werden kann. Diese max. Anzahl beträgt 49 Innenstation-Monitor bzw. 49 Wohnungen/Apartments.

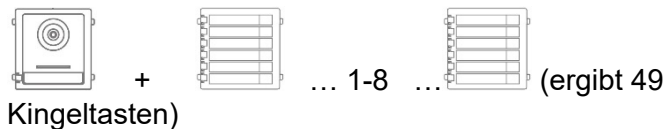

Nur bei Einstellung „Innen-Erweiterung“:

Nr. (1~5): Konfiguration der Nummer der Innen-Erweiterung. Es sind max. 5 Erweiterungsmonitor möglich.

Raumname: Bezeichnung für den Raum wo sich der Erweiterungsmonitor befindet.

Livebilddauer (10~60s): Dauer für die Anzeige des manuell angeforderten Livebildes eines Tür-Videomoduls oder angeschlossenen IP Kamera. (aufrufbar über Hauptseite / Livebild)

Informationen zum Einrichten weiterer Klingeltasten im Mehrparteienhaus finden Sie im Abschnitt Installations- und Inbetriebnahmehinweise im Kapitel „9.3 Einrichtung erweiterter Klingeltasten für Mehrparteien-Haus“.

### **Einstellungen ABUS Link Station-Dienst:**

Die ABUS Link-Station Funktion dient zur einfachen Einrichtung und Verbindung einer Smartphone App mit dem Türsprechsystem. Es sind dazu nur wenige Schritte nötig. Es muss dazu eine aktive Internetverbindung der Türstation mit dem Internet vorliegen.



Dieses Menü existiert nur an einem Monitor mit der Einstellung „Innenstation“ (Hauptmonitor).

Aktivieren Sie diese Funktion, wenn Sie den App-Zugriff auf die Türsprechanlage verwenden möchte.

Vorgehensweise:









1. Installieren Sie die ABUS Link Station APP (lite/pro) (Android/iOS)
2. Klicken Sie in der App auf „Gerät hinzufügen“ bzw. „QR-Code scannen“.
- 3 Scannen Sie den QR-Code welcher in der Einstellungsseite zum ABUS Link Station Dienst abgebildet ist. Jeder Innenstation-Monitor hat einen eigenen QR Code.
4. Während des Einrichtungsprozesses ist die Eingabe des Verifizierungscode notwendig. Dieser ist ebenfalls in der Einrichtungsseite abgebildet und kann nach belieben geändert werden.

Ein QR-Code kann nur zu einem ABUS Link Station Konto hinzugefügt werden. Weitere Konten können per Freigabe Zugang zur Türsprechanlage erhalten.

	Einstellungen ABUS Link Station-Dienst	
ABUS Link Station-Dienst aktivieren		
Verifizierungscode		xxxxx
ABUS Link Station-Serverstatus		Verbunden
		











Zeit synchronisieren:

Zeiteinstellung über das NTP Protokoll aktivieren.  
Der Intervall legt die Aktualisierungsfrequenz in Minuten fest.  
Das Feld IP-Adresse erlaubt die Eingabe einer NTP Serveradresse oder IP-Adresse.  
Die Portnummer ist auf 123 fixiert (Standard Port für das NTP Protokoll).  
Wählen Sie die Zeitzone aus in der sich die Türsprechanlage befindet (üblicherweise GMT+01:00)

	Zeitsynchronisation		
 NTP aktivieren			
Inervall synchronisieren	60		
IP-Adresse	0.pool.ntp.org		
Port-Nr.	123		
Anrufumleitung	(GMT+1:00 Amsterdam, Berlin, Rom, Paris		
			

	<p><b>Bei Verwendung des ABUS Link Station Dienstes in Verbindung mit der Push Funktion bei Klingelruf muss unbedingt die NTP funktion aktiviert und korrekt konfiguriert sein.</b></p> <p><b>Achten Sie unbedingt auf die korrekte NTP Serveradresse „0.pool.ntp.org“.</b></p>
--	---

**Sommerzeit:** Eingabe der Details zu den Umschaltzeiten zwischen Sommerzeit und Winterzeit.

	Sommerzeit		
 Sommerzeit aktivieren			
Startzeit	März Letzte Woche Sonntag 2:00		
Endzeit	Oktober Letzte Woche Sonntag 3:00		
Verschiebung	60min		
			

**Assistent:** Erneutes Starten des Installationsassistenten. Folgende Schritte werden beim Assistenten durchlaufen:  
a) Spracheinstellung  
b) Netzwerkeinstellung (drahtgebundene Schnittstelle)



c) Installationstyp bzw. Arbeitsweise des Monitors (Innenstation oder Innenerweiterung) und Apartmentnummer







d) Geräteverbindung zum Monitor.

Wenn Innenstation-> Zuweisung eines Tür-Videomoduls

Wenn Erweiterung -> Zuweisung des Hauptmonitors  
(Innenstation)







#### 5.2.4.2 Konfiguration – Netzwerkeinstellungen

Dieses Menü befasst sich mit den Einstellungen für die drahtgebundene Netzwerkschnittstelle

	Netzwerkeinstellungen		
 DHCP			
Lokale IP	192.168.0.11		
Subnetzmaske	255.255.255.0		
Gateway	192.168.0.1		
DNS-Adresse	192.168.0.1		
DNS-Adresse 2	194.25.2.129		

Schaltfläche / Anzeige	Beschreibung
DHCP	DHCP an/ausschalten. Es wird dringend empfohlen sämtliche Komponenten des Türsprechsystems auf eine fixe IP zu setzen.
Lokale IP	Stellen Sie hier die lokale IP des Gerätes ein
Subnetzmaske	Stellen Sie hier die Subnetzmaske des Gerätes ein
Gateway	Stellen Sie hier das Gateway des Gerätes ein. Im Regelfall wird hier die IP des Routers verwendet.
DNS-Adresse	Stellen Sie hier die DNS Adresse für das Gerät ein. Im Regelfall wird hier die IP des Routers verwendet.
DNS-Adresse 2	Stellen Sie hier die alternative DNS Adresse für das Gerät ein. Im Regelfall wird hier die IP des Routers verwendet.

### 5.2.4.3 Konfiguration – Geräteverwaltung

	Geräteverwaltung		
Haupt-Türstation	192.168.0.26		
			  

Die Funktion dieses Menüs unterscheidet sich grundlegend zwischen Innenstation und Innen-Erweiterung. Hier können Sie die Zuweisungen der Geräte untereinander ändern.

#### **Achtung:**

Der Hauptmonitor eines Systems muss immer mit dem Haupt-Videomodul verknüpft werden. Ein Erweiterungsmonitor eines Systems muss immer mit dem Hauptmonitor des Systems verknüpft werden.

**Innenstation:**

- Zuweisung der Haupt-Türstation
- Hinzufügen von weiteren IP Netzwerkkameras für eine Live-Ansicht.







Klicken Sie hierfür rechts oben auf das „+“ Symbol und wählen sie „Privates Protokoll“ für eine ABUS Netzwerkkamera aus.

**Innen-Erweiterung:** - Zuweisung der Innenstation (Haupt-Monitor)

In diesem Menü können zusätzlich folgende Interaktionen durchgeführt werden:

- Einstellen der Netzwerkparameter (DHCP, IP Adresse etc.) des Video-Türmoduls
- Durchführung eines Reset auf Werkseinstellung des Video-Türmoduls

### Einstellen der Netzwerkparameter des Video-Türmoduls

Türstation Einstellungen	
192.168.0.26	
255.255.255.0	
192.168.0.1	
DHCP	<input type="checkbox"/>
Mikrofonlautstärke	 70% 
Klingeltonlautstärke	 70% 
Gesprächslautstärke	 70% 
Abbrechen	OK

- Zeile 1 -3:** IP Adresse, Gateway und Subnetzmaske
- DHCP:** Bei Betätigen der Schaltfläche wird die Abfrage der IP Adressdaten vom DHCP Server gestartet. Der Schalter geht anschließend wieder nach links. Die erhaltenen IP Adressdaten werden anschließend als feste Daten eingestellt. Eine weitere automatische Abfrage der Daten erfolgt nicht.
- Mikrofonlautstärke:** Einstellen der Empfindlichkeit des Mikrofons im Video-Türmodul
- Klingeltonlautstärke:** Einstellen der Lautstärke des Ruftones nach Betätigen der Klingeltaste am Video-Türmodul
- Gesprächslautstärke:** Einstellen der Lautstärke während des Gespräches am Video-Türmodul

### Durchführung eines Reset auf Werkseinstellung des Video-Türmoduls

Hier können alle Einstellungen des Video-Türmoduls über den Hauptmonitor zurückgesetzt werden.

Alle Standardparameter wiederherstellen?	
Abbrechen	OK

## Hinzufügen einer ABUS Netzwerkkamera

Um eine ABUS Netzwerkkamera dem System hinzuzufügen, klicken Sie bitte auf das „+“ Symbol rechts oben unter „Gerät hinzufügen“.

Wählen Sie „Privates Protokoll“ für ABUS Kameras aus und vergeben Sie einen beliebigen Gerätenamen. Zusätzlich wird die IP Adresse der Kamera im Netzwerk sowie der RTSP Port (Standard 554) zur Einbindung benötigt. Abschließend müssen Sie noch den Benutzernamen und Passwort ihrer Netzwerkkamera eintragen.









Die Liste kompatibler ABUS Netzwerkkameras finden Sie [www.abus.com](http://www.abus.com).

### 5.2.4.4 Konfiguration – Standardeinstellungen

**Standardeinstellungen:** Setzt den Monitor auf Standardeinstellungen zurück. Die Aktivierung/Passwort bleibt erhalten.

**Werkseinstellungen:** Setzt den Monitor komplett inkl. Passwort auf Werkseinstellungen zurück. Der Monitor befindet sich danach im „Inaktiven“ Zustand.

### 5.2.5 Relais Konfiguration

<		Relais Konfiguration		
	Relais 1			
Dauer			3s	
Intervall			5s	
	Relais 2			

Unter „Relais-Konfiguration“ werden die zwei Relais des Monitors selbst konfiguriert. Die Konfiguration in diesem Menü hat keinerlei Einflüsse auf die Relais des Video-Türmoduls.

Die Relaisausgänge befinden sich an der Rückseite des Monitors und können über die mitgelieferte Kabel-Peitsche angeschlossen werden. Die Belegung befindet sich aufgedruckt auf der Rückseite des Monitors.

Das **Relais 1** wird zwischen COM1 und NO1 geschaltet, das **Relais 2** wird an COM2 und NO2 abgegriffen.

Schaltfläche / Anzeige	Beschreibung
Relais 1	Aktiviert / Deaktiviert die Funktion einer zusätzlichen (oder einer bereits bestehenden) Hausglocke. Das Relais 1 am Monitor wird parallel zu einem Anruf getriggert.
Dauer	Legt die Dauer fest wie lange das Relais für

	die zusätzliche Türglocke bei einem Klingelruf getriggert wird.
Intervall	Legt das Intervall fest in welchem das Relais für die eingestellte „Dauer“ die zusätzliche Türglocke bei einem Klingelruf ausgelöst wird.
Relais 2	Aktiviert / Deaktiviert den zusätzlichen Schaltausgang am Monitor (z.B.: für einen Türöffner an der Wohnungstür in der jeweiligen Etage). Bei aktivierter Funktion erscheint ein weiteres „Schlüssel-Symbol“ mit der Beschriftung „3“ am lokalen Monitor.

Für weitere Informationen lesen Sie die Kapitel „9.6 Anschluss vorhandener Türöffner an Türstations-Monitor“ und „9.5 Anschluss einer vorhandenen Haustürklingel“ im Abschnitt Installations- und Inbetriebnahmehinweise.

Ebenfalls finden Sie hier Informationen zu folgendem Thema: „9.8 Anschluss elektrischer Türöffner an Video Modul (inkl. „Gartentor““

### 5.2.6 *microSD-Karte*

Schaltfläche / Anzeige	Beschreibung
Formatieren	<b>Achtung !</b> Die komplette microSD Karte wird formatiert und alle darauf befindlichen Daten gelöscht.
Deinstallieren	Deaktiviert die microSD Karte, es findet danach keine Aufzeichnung mehr statt. Sie können die microSD Karte problemlos entnehmen.

### 5.2.7 *Bildschirm sperren*

Sperrt den Bildschirm für 30 Sekunden. In dieser Zeit ist das Touchpanel deaktiviert und kann z.B. gereinigt werden

### 5.2.8 *Geräteinformationen*

Hier finden Sie die Firmwareversion des Monitors sowie Modell und Seriennummer ihres Gerätes. Zur Update-Anleitung wechseln Sie bitte zum Kapitel „ABUS CMS Software: Firmware Update“ im Abschnitt Installations- und Inbetriebnahmehinweise.

### 5.2.9 *Zeiteinstellung*





Hier können Sie die Uhrzeit/Datum des Monitors manuell einstellen. Alternativ können Sie auch im Hauptbildschirm auf die Uhrzeit direkt klicken.

### 5.2.10 Gerät neu starten

Startet den Monitor neu.

### 5.2.11 Passworteinstellungen (PIN-CODE)

#### PIN-Vergabe für Tastenfeld TVHS20030(S)

	Passworteinstellungen	
Pin-Code		
		

Hinweis: Hierfür benötigen Sie das Tastenfeld für die PIN CODE Eingabe TVHS20030(S).

Hier können Sie einen 6-stelligen Key einstellen welcher dann gültig für das Öffnen der Tür 1 (Relais 1 am Video-Türmodul 1) via Tastenfeld ist. Der PIN Code ist immer 6-stellig.

Um den PIN am Tastenfeld einzugeben, bitte folgende Kombination drücken:

Bis Firmware V2.0.8 / V2.1.2 build 200410:

„#“ 6-stelliger PIN „#“. Beispiel: #123456#

Ab Firmware V2.2.3 / V2.1.2 build 201029:

„#“ Wohnungsnummer 6-stelliger PIN „#“. Beispiel: #1123456#

→ d.h. ab dieser Firmware kann der PIN für jede Wohnung individuell eingestellt werden.

→ Ändern und Löschen es wohnungsabhängigen PINs ist nun möglich

Lokal am Monitor kann **ein** PIN CODE vergeben werden. **Drei** weitere Codes können über die Remote-Konfiguration der ABUS CMS Software eingegeben werden (globale Codes, nicht wohnungsbezogen. Um einen Code via ABUS CMS Software hinzuzufügen, öffnen Sie hierzu die Remote-Konfiguration des Tür-Videoomoduls und wählen den Menüpunkt „Intercom“ und „Permission password“. Die PIN Codes werden generell im Videomodul gespeichert und nicht im Tastenfeld.

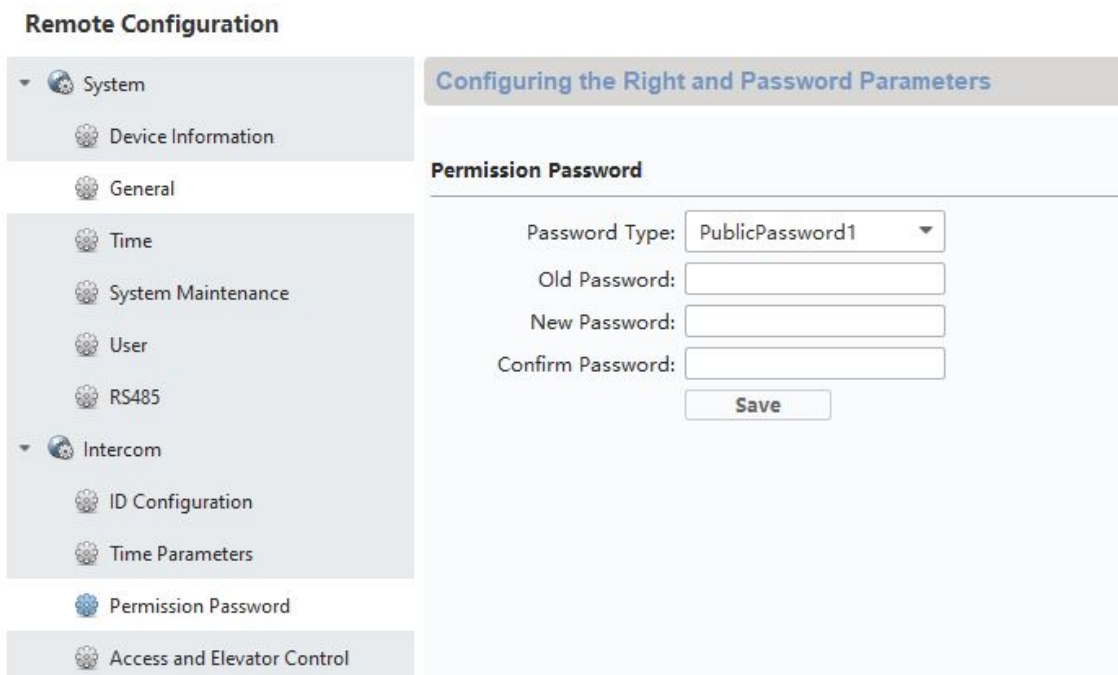

### 5.2.12 *Systemsprache*

Wählen Sie ihre gewünschte Sprache aus.

### 5.2.13 *Helligkeitseinstellung*

Hier können Sie die Helligkeit des Monitors im Bereich von 0 – 100 % einstellen.

### 5.2.14 *Etagentaster*

Aktiviert / Deaktiviert die Etagentaster-Funktion. Bei aktivierter Funktion erscheint auf der rechten Seite ein weiterer Menüpunkt unter dem „WLAN“ Symbol. Die Etagentaster-Funktion steht nun zur Verfügung und kann über die verdrahteten Eingänge des Monitors verwendet werden. Weitere Erklärungen finden Sie unter „9.7 Anschluss Etagen Klingeltaster an Haupt-Monitor“ im Abschnitt Installations- und Inbetriebnahmehinweise

### 5.2.15 *Open Source Lizenzinformationen*

Bitte lesen Sie die Open Source Lizenzinformationen am Ende dieses Dokumentes (Abschnitt 8).

## 6. Wartung und Reinigung

### 6.1 Funktionstest

Überprüfen Sie regelmäßig die technische Sicherheit des Produkts, z. B. Beschädigung des Gehäuses.

Wenn anzunehmen ist, dass ein gefahrloser Betrieb nicht mehr möglich ist, so ist das Produkt außer Betrieb zu setzen und gegen unbeabsichtigten Betrieb zu sichern. Es ist anzunehmen, dass ein gefahrloser Betrieb nicht mehr möglich ist, wenn

- das Gerät sichtbare Beschädigungen aufweist
- das Gerät nicht mehr funktioniert
- eine längere Lagerung unter ungünstigsten Verhältnissen zurückliegt
- das Gerät beim Transport Beanspruchungen ausgesetzt war



**Bitte beachten Sie:**

Das Produkt ist für Sie wartungsfrei. Es sind keinerlei für Sie zu überprüfenden oder zu wartenden Bestandteilen im Inneren des Produkts – öffnen Sie es niemals.

### 6.2 Reinigung

Reinigen Sie das Produkt mit einem sauberen trockenen Tuch. Bei stärkeren Verschmutzungen kann das Tuch leicht mit lauwarmem Wasser angefeuchtet werden.



Achten Sie darauf, dass keine Flüssigkeiten in das Geräteinnere kommen, dadurch wird das Gerät zerstört. Verwenden Sie keine chemischen Reiniger, dadurch

könnte die Oberfläche des Gehäuses angegriffen werden.

## 7. Entsorgung



Geräte, die so gekennzeichnet sind, dürfen nicht über den Hausmüll entsorgt werden. Entsorgen Sie das Produkt am Ende seiner Lebensdauer gemäß den geltenden gesetzlichen Bestimmungen.

Bitte wenden Sie sich an Ihren Händler bzw. entsorgen Sie die Produkte über die kommunale Sammelstelle für Elektroschrott.



## **8. Open Source Lizenzhinweise**

Das Produkt enthält Softwarebestandteile, die von den Rechteinhabern als Freie Software bzw. Open Source Software lizenziert werden (nachfolgend als „OSS“ bezeichnet). Die entsprechenden Lizenzen sind in gedruckter Ausgabe dem Produkt beiliegend und/oder über eine grafische Benutzeroberfläche abrufbar. Sie können Nutzungsrechte in dem dort geregelten Umfang unmittelbar von den Rechteinhabern erwerben. Die Open Source-Lizenzen haben Vorrang vor allen anderen Lizenzbedingungen und vertraglichen Vereinbarungen mit ABUS in Bezug auf die entsprechenden im Produkt enthaltenen OSS-Softwarekomponenten.

Generell können Lizenzinformationen zu ABUS Produkten auf [www.abus.com](http://www.abus.com) im Downloadbereich der Produktbeschreibung abgerufen werden.

## 9. Installations- und Inbetriebnahmehinweise

### 9.1 Verwendung Sicherheitsmodul (TVHS10040/TVHS20340)

Das Sicherheitsmodul TVHS10040 (bzw. neue Artikelnummer TVHS20340) dient dazu, den Türöffner-Anschluss in den geschützten Innenbereich zu verlegen und somit vor Sabotage zu schützen. Das Sicherheitsmodul wird mit 12V Spannung versorgt und mittels RS485-BUS an das Tür-Video modul angeklemt.

Bitte verwenden Sie das beim Tür-Video modul beiliegende 4-Pin Kabel. Dieses Kabel muss an einer Steckerseite abgetrennt werden und die Kabel mit dem Sicherheitsmodul verbunden werden. Die ID Dip-Schalter am Sicherheitsmodul werden hier nicht benötigt und bleiben auf Standard-Wert gesetzt. (DIP Schalter 1 an, DIP Schalter 2/3/4 aus)

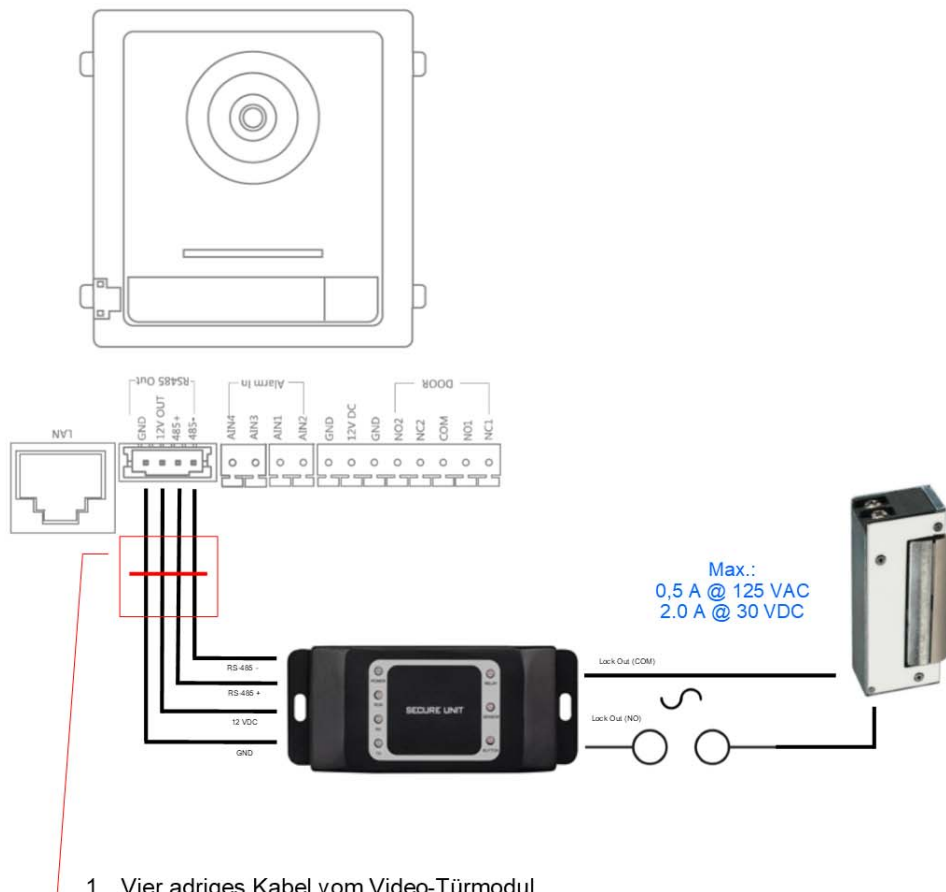

1. Vier adriges Kabel vom Video-Türmodul durchtrennen (Lieferumfang)
2. Die 4 Adern mit folgender Farbzugehörigkeit an das Sicherheitsmoduls anschließen.





**Bis Firmware V2.0.8 / V2.1.2 build 200410:**

Das Sicherheitsmodul muss noch als neues Tür-Relais konfiguriert werden. Hierzu öffnen Sie die Remote-Konfiguration des Tür-Videomoduls mit der ABUS CMS Software und gehen auf das Menü „Intercom“ / „IO In Out“ und setzen „IO Out“ für „DOOR 1“ auf „securityModule“

**Ab Firmware V2.2.3 / V2.1.2 build 201029:**

Nach Anschluss des Sicherheitsmoduls wird dieses Automatisch erkannt.

Nun wird beim Tür-öffnen-Vorgang nicht mehr das interne Relais des Tür-Videosprechmoduls sondern das Relais Sicherheitsmodules angesteuert. Während das Relais aktiv ist, leuchtet die grüne LED „Relay“ am Sicherheitsmodul auf.

**Achtung:** Es kann nur ein Sicherheitsmodul TVHS10040/TVHS20340 pro Video-Türmodul verwendet werden!

**Hinweis:** Das Sicherheitsmodul wird immer als letztes Modul angesteckt. Hierbei spielt es keine Rolle ob nur ein Video-Türmodul oder zusätzliche Erweiterungsmodul angesteckt sind.

Belastbarkeit des Relais: max. 2A 30VDC / 0.5A 125AC

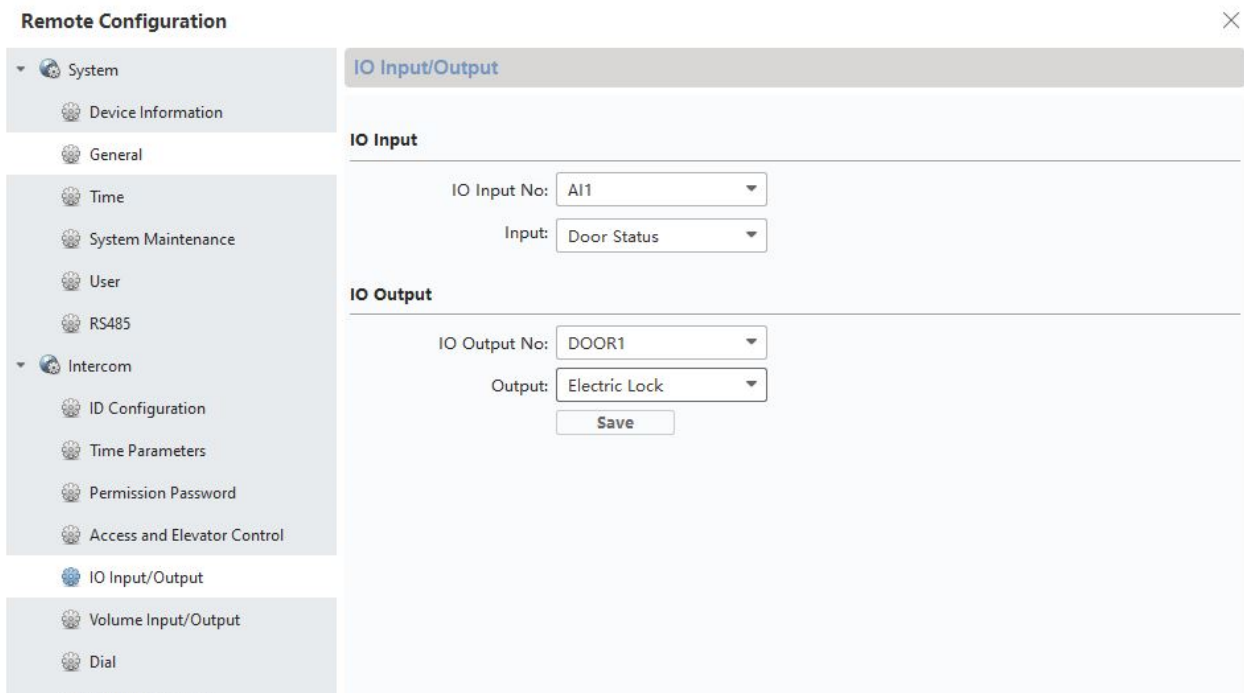

## 9.2 Einrichtung Nebeneingänge

Wenn Sie einen weiteren Tür-Videomodul (maximal 16) in das System integrieren möchten um einen Neben-Eingang zu realisieren (Z.B.: Warenannahme, Kellertüre etc) gehen Sie bitte folgende Schritte durch:

- 1) Verbinden Sie das Tür-Videomodul des Nebeneingangs mit dem Netzwerk der Haupt-Türsprechstelle. Sämtliche Geräte der Türsprechstation müssen sich im physikalischen LAN befinden.
- 2) Öffnen Sie die ABUS CMS Software und aktivieren Sie das Türmodul des Nebeneinganges.
- 3) Fügen Sie das Türsprechmodul des Nebeneinganges der ABUS CMS Software hinzu und öffnen die Remote-Konfiguration.
- 4) Unter „Intercom“ wechseln Sie nun in das „Room Number“. Unter „No.“ wird die Nummer des Nebeneinganges eingetragen. Das Haupt-Türvideomodul muss die Nummer „0“ haben. Die zusätzlichen Nebeneingänge werden von 1-16 durchnummeriert. Verändern Sie nicht „Period/Building/Unit oder Floor“-Nummern.

Nachdem Speichern startet das System neu. Hierzu bitte mit „OK bestätigen“.

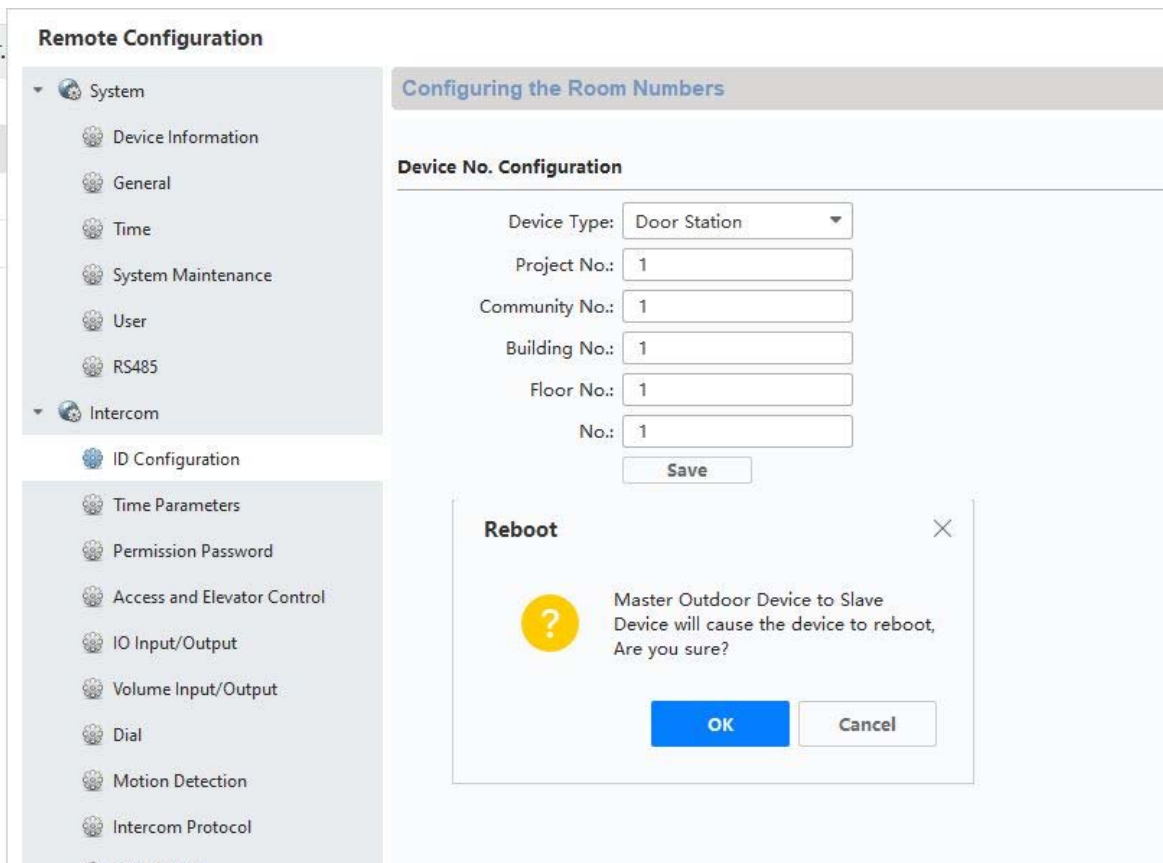

- 5) Nachdem erfolgreichen Neustart müssen Sie dem Nebeneingang noch die Haupt-Türe zugewiesen werden. Hierzu unter „*Network / Linked Network Configuration / (Main) Door IP Address*“ die IP Adresse der **Haupt-Türstation** eintragen und speichern.

**Achtung:** Das Menü „*(Main) Door IP Adress*“ erscheint nur, wenn Sie Schritt 4) ordnungsgemäß durchgeführt haben.

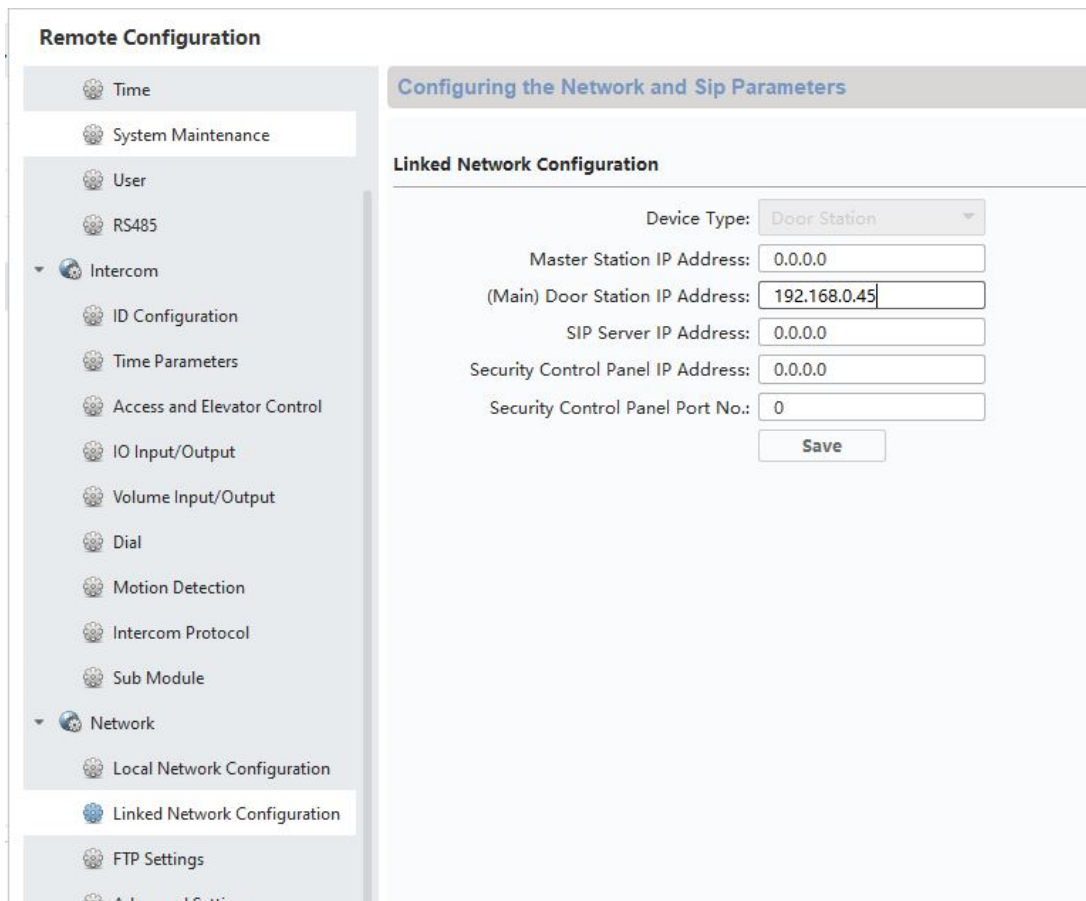

- 6) Die Einrichtung eines Nebeneinganges ist nun fertig gestellt. Wenn nun am Nebeneingang ein Klingelruf gestartet wird, erscheint am Monitor auch, dass der Anruf von einem Nebeneingang gestartet wurde. Unter „LIVEBILD“ beim Monitor kann nun auch direkt auf das Videobild vom Nebeneingang zugegriffen werden und die Türe geöffnet werden.

### 9.3 *Einrichtung erweiterter Klingeltasten für Mehrparteien-Haus*

Über die zusätzlichen Zusatzmodule (TVHS20020(S)) können bis zu 49 Klingeltaster für Mehrparteien-Häuser realisiert werden. Das Erweiterungsmodul wird via Verbindungskabel am Haupt-Videomodul angeschlossen.

Wenn nur ein Zusatz-Klingeltastermodul verwendet wird, kann die Installation ohne der ABUS CMS Software erfolgen.

Das Haupt-Türmodul ist standardmäßig die Klingel mit der „Apartment-Nummer 1“. Das Erweiterungsmodul TVHS20020(S) ist automatisch auf Apartment-Nummer 2 – 7 eingestellt. Das „Apartment“ entspricht hier je einer eigenständigen Wohnung.

Wenn Sie die Klingeltaste des Haupt-Videomoduls nicht verwenden und mittels Abdeckplatte verschließen, müssen Sie das Erweiterungsmodul TVHS20020(S) via ABUS CMS Software konfigurieren. Unter „Intercom“ / „Submodule“ finden Sie alle am RS-485 BUS

angeschlossenen Erweiterungsmodule. (Ausnahme: Das Sicherheitsmodul TVHS10040/TVHS20340 erscheint hier nicht)

Im Menü „*Sub module*“ klicken Sie bitte auf das „Einstellungen“-Symbol um die Zuweisung der Apartmentnummern vorzunehmen.

Die Submodul ID hängt von der eingestellten ID via DIP-Schalter an der Gehäuse-Rückseite der Erweiterungsmodule ab. Damit lässt sich bei einem Aufbau mit mehreren Erweiterungsmodulen einfach das passende zuordnen.

**Achtung:** Nach Änderung der ID via DIP Schalter muss das jeweilige Erweiterungsmodul kurz vom Kabel getrennt werden und neugestartet werden.

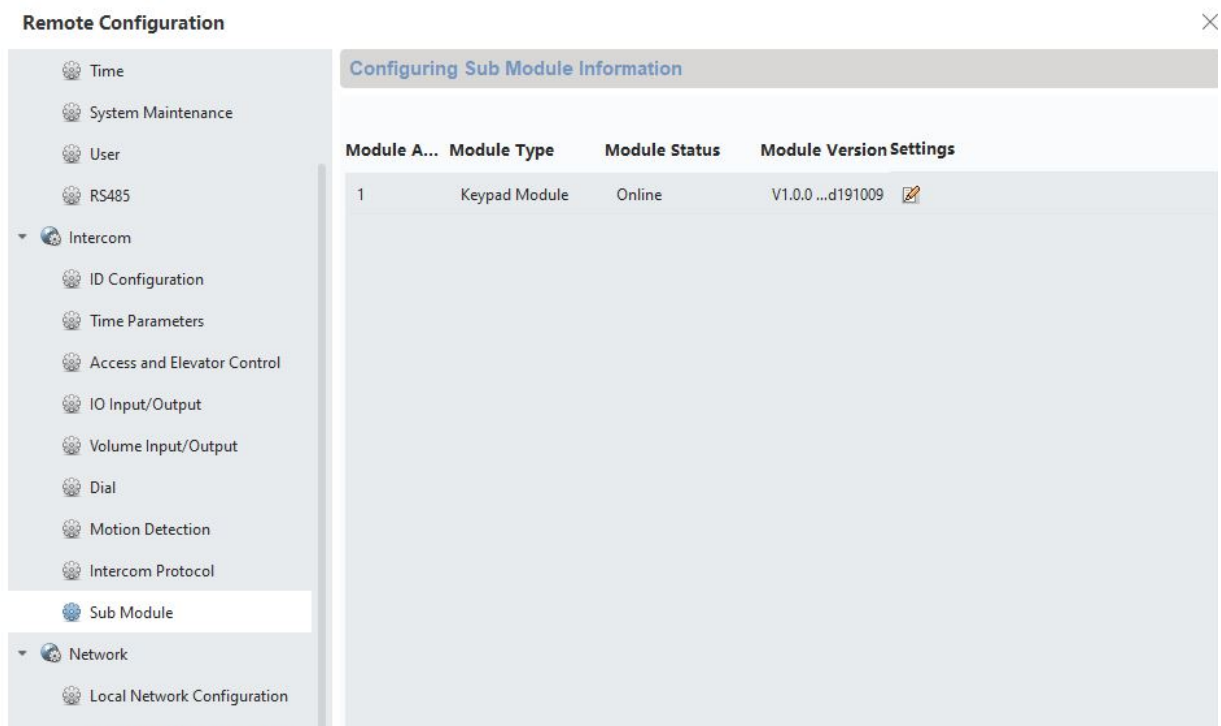

The screenshot displays the 'Remote Configuration' window with a sidebar menu on the left and a main configuration area on the right. The sidebar menu includes options like Time, System Maintenance, User, RS485, Intercom, and Network. The 'Sub Module' option is selected. The main area is titled 'Configuring Sub Module Information' and contains a table with the following data:

Module A...	Module Type	Module Status	Module Version Settings
1	Keypad Module	Online	V1.0.0 ...d191009 

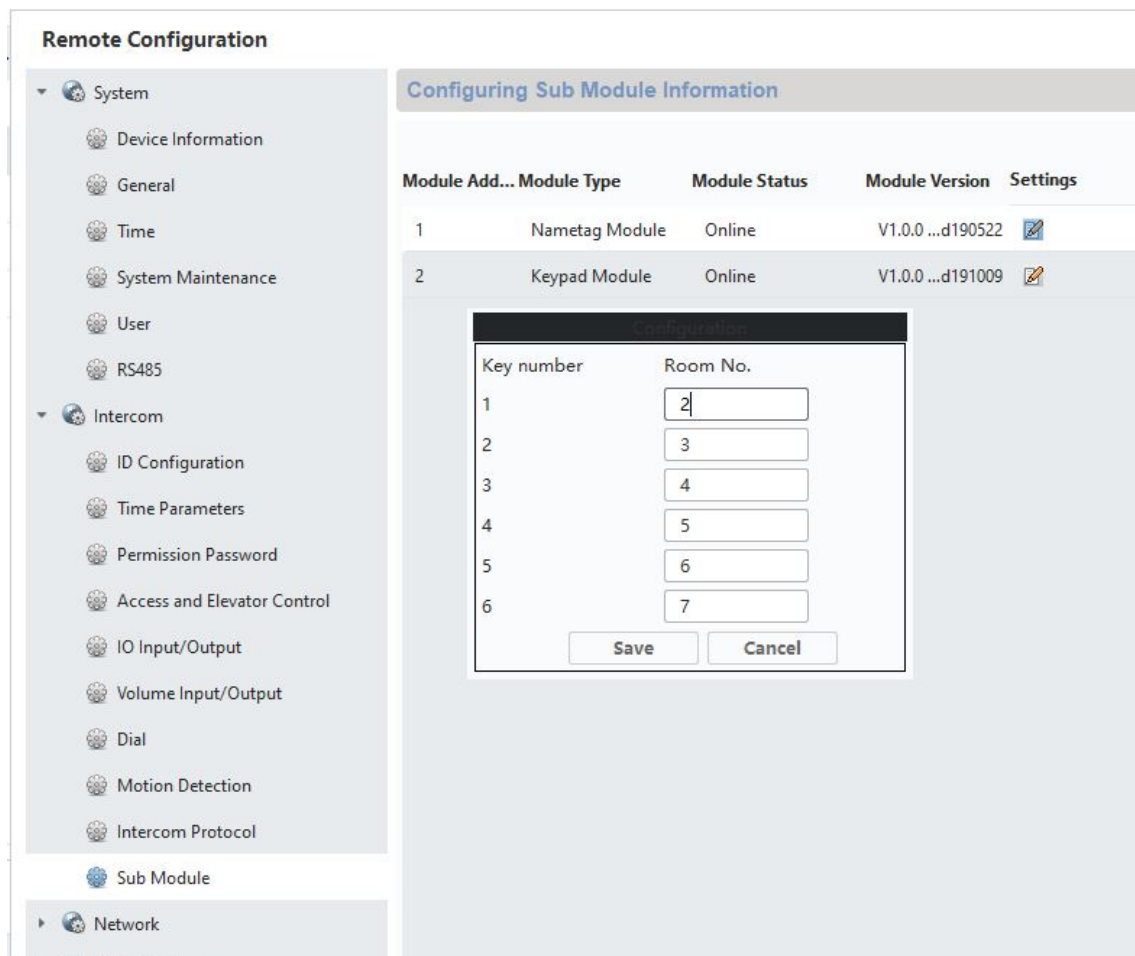

Konfiguration der Apartmentnummer/Wohnungsnummer im Monitor:

Damit die Klingeltasten der Wohnungen den richtigen Monitoren zugewiesen werden, müssen die Apartmentnummern der Monitore mit den Klingeltasten-Nummern übereinstimmen.

Die Apartmentnummer des jeweiligen Monitors wird in der Haupt-Übersicht des Monitors angezeigt.

Sie können die Nummer entweder direkt in der Konfiguration im Monitor ändern (Konfiguration/ Apartmentnr.) oder auf den jeweiligen Monitor mittels ABUS CMS Software zugreifen und im Menü „Intercom“/„Room Number“ die Apartment/Wohnungsnummer unter „room.No.“ ändern.



Beispiel für die Abdeckung der Klingeltaste am Video-Türmoduls

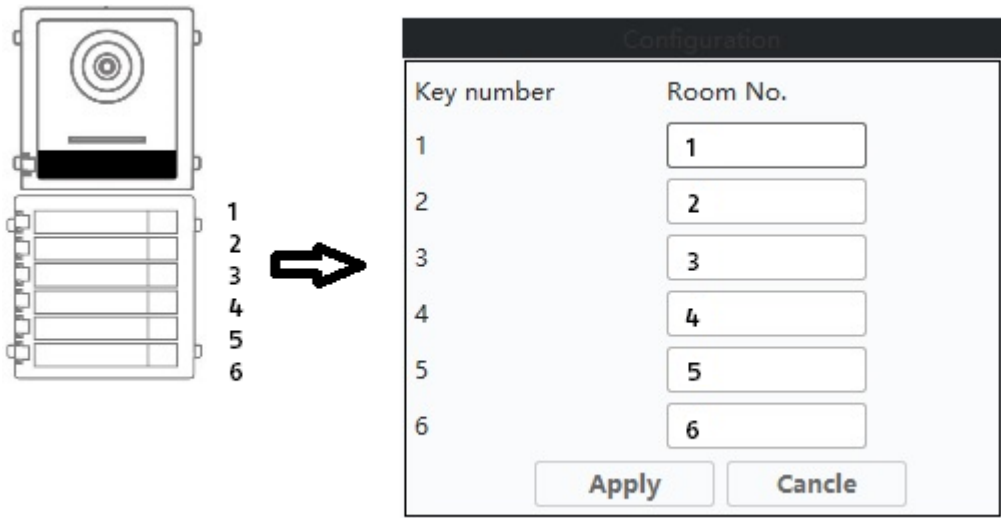

#### 9.4 Lautstärke am Tür-Videomodul (TVHS20000(S), TVHS20010(S)) einstellen

Über die ABUS CMS Software können die Mikrofon-Empfindlichkeit und Sprachlautstärke am Tür-Videomodul eingestellt werden. Zusätzlich können Sie die Bestätigungstöne / Anruf-Wahlöne / Belegt-Zeichen- Lautstärke einstellen oder gänzlich deaktivieren.

Schaltfläche / Anzeige	Beschreibung
Volume In	Regelt die Mikrofon-Empfindlichkeit des Tür-Videomoduls. Je höher der Wert, desto lauter wir die Sprache zum Monitor übertragen.
Volume Out	Regelt die automatische Sprachausgabe (z.B.: Hinterlassen Sie eine Nachricht, Anruf fehlgeschlagen etc. Zudem kann über diesen Regler die Lautstärke der Bestätigungstöne / Anruf-Wahlöne und Belegt-Zeichen eingestellt werden. (Auf 0 ist es komplett lautlos)
Talk Volume	Hier wird die Sprachlautstärke eingestellt. Je höher der Wert, desto lauter wird die Sprache vom Monitor an die Türstation übertragen.

**Remote Configuration**

- System
  - Device Information
  - General
  - Time
  - System Maintenance
  - User
  - RS485
- Intercom
  - ID Configuration
  - Time Parameters
  - Permission Password
  - Access and Elevator Control
  - IO Input/Output
  - Volume Input/Output**
  - Dial
  - Motion Detection
  - Intercom Protocol

### Configuring the Volume Input or Output

**Volume Input**

Volume:  7

**Volume Output**

Volume:  7

**Talk Volume**

Talk Volume:  7

## 9.5 Anschluss einer vorhandenen Haustür Klingel

Wenn Sie bereits eine vorhandene Haustür-Klingel / Gong besitzen, kann dieser am Relaisausgang 1 (COM / NO I) des Monitors angeschlossen werden.

	<p><b>Das Relais darf maximal mit max. 2A @ 30VDC bzw. 0.5A @ 125AC belastet werden.</b></p>
---	--

Bei einem Klingelruf wird das Relais dann im gewünschten Intervall und Zeitdauer geschaltet. Die Konfiguration des „Relais 1“ finden Sie im Menü des Monitors unter „Relais-Konfiguration“.

Das Relais wird, ebenso wie der lokale Klingelton am Monitor, solange angesteuert wie unter „Klingeltondauer“ im Menü „Anrufeinstellungen“ eingestellt ist.

Wenn Sie nur das Klingeln Ihres externen Hausgongs hören möchten, können Sie den Klingelton am Monitor einfach in den „Anrufeinstellungen“ im Menü „Klingelton aktivieren“ aktivieren oder deaktivieren.

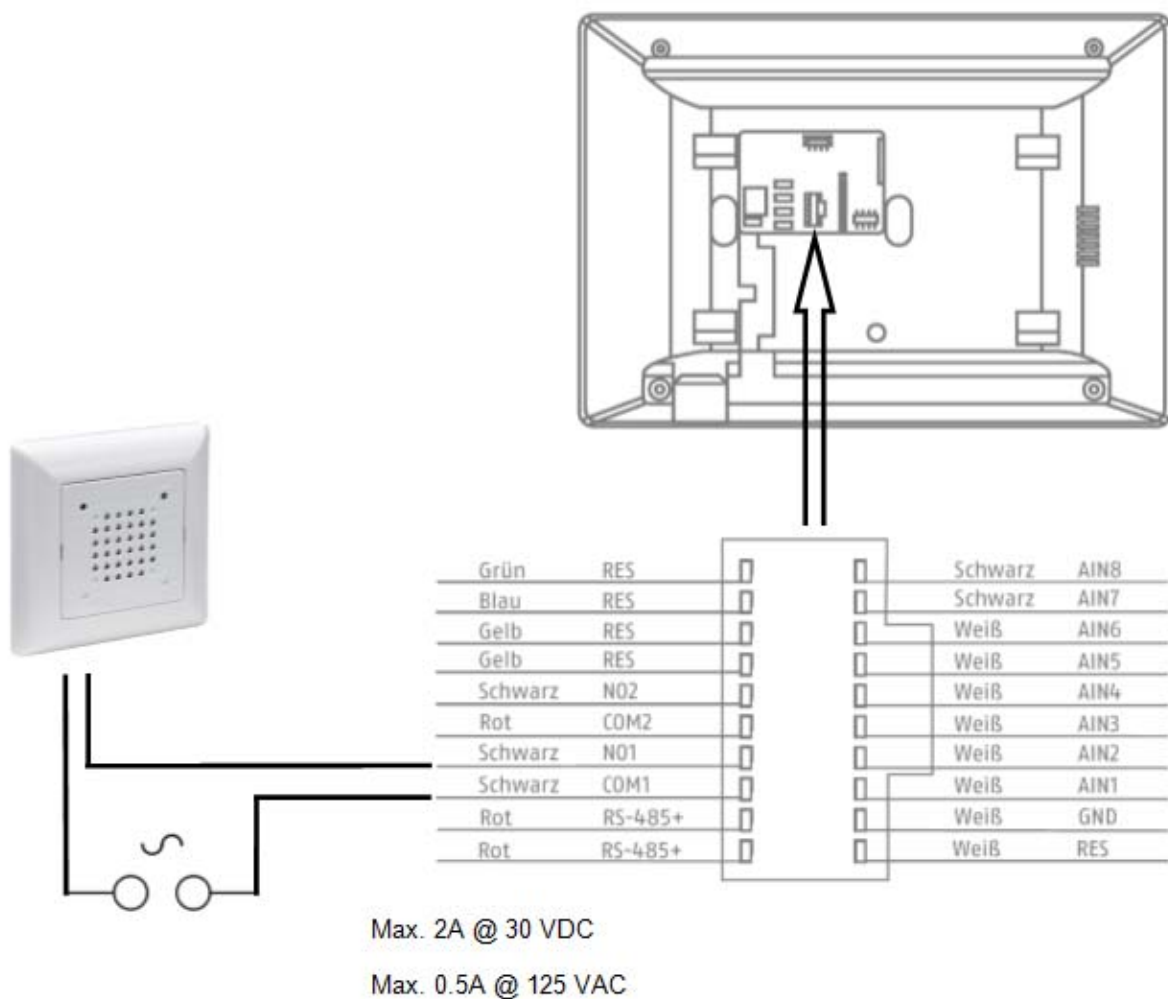

## 9.6 Anschluss vorhandener Türöffner an Türstations-Monitor

Um eine Wohnungstür getrennt von einer Haupt-Eingangstür zu Öffnen bietet der Monitor die Möglichkeit über einen Relaisausgang (Relais 2) eine weitere Türe anzusteuern.

	<p><b>Das Relais darf maximal mit max. 2A @ 30VDC bzw. 0.5A @ 125AC belastet werden.</b></p>
---	--

Um das Relais am Monitor zu verwenden, bitte zuvor im Monitor-Menü unter „Relais-Konfiguration“ das „Relais 2“ aktivieren. Im Monitor erscheint nun ein weiteres „Schlüssel“-Symbol mit einer „3“ als Kennung. Kennung „1“ und „2“ sind für die Relais vom Tür-Videomodul reserviert.

Das Relais „3“ am Monitor kann nur über den Monitor direkt geschaltet werden, nicht via ABUS LINK STATION App.

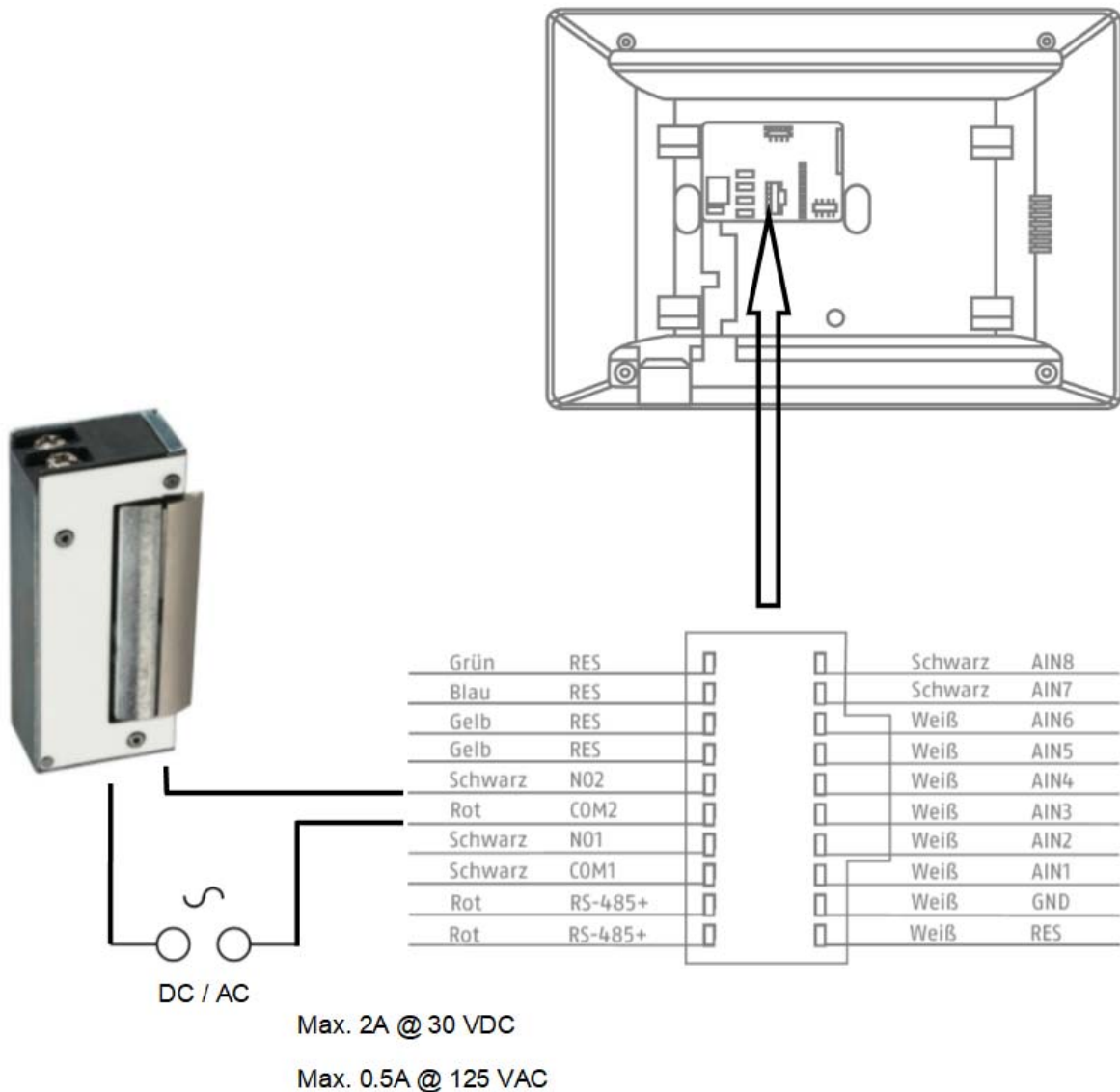

## 9.7 Anschluss Etagen Klingeltaster an Haupt-Monitor

Der Etagentaster (Klingeltaster direkt an der Wohnungstür an einem Mehrparteien-Haus) kann direkt an den Monitor angeschlossen werden. Direkt verdrahtet an den Alarmeingang 1 kann der Monitor ein Klingelsignal ausgeben und dem Kunden signalisieren, dass an der oberen Wohnungstür geklingelt wurde.

**Hinweis:** Der Klingelton des Etagentasters kann nicht geändert werden. Er unterscheidet sich von einem Klingelruf vom Tür-Video modul, so dass ersichtlich ist, woher der Klingelruf gestartet wurde. Der Etagentaster führt zu keiner Interaktion am Monitor. Es ertönt nur ein kurzer Klingelton.

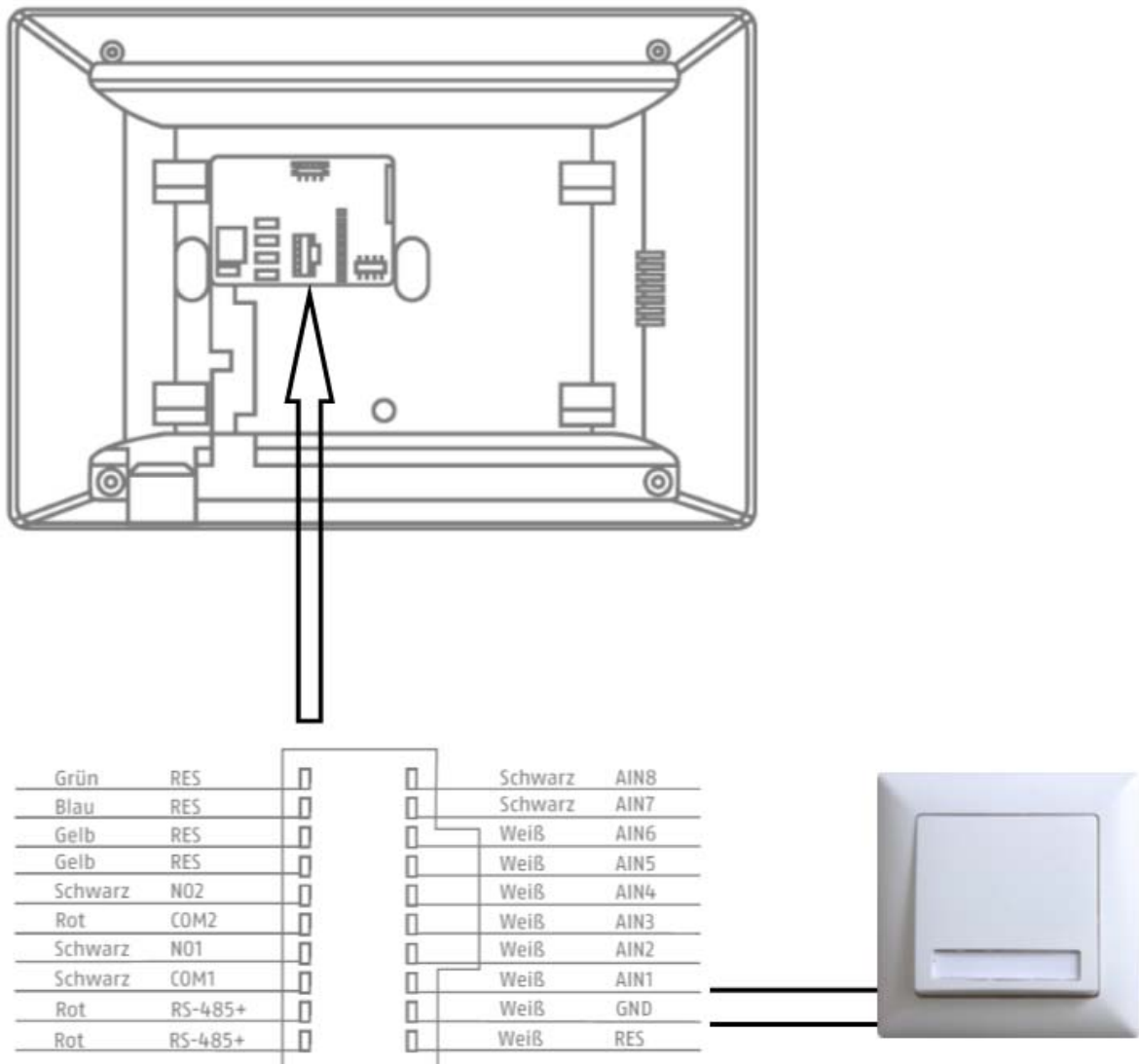

## 9.8 Anschluss elektrischer Türöffner an Video Modul (inkl. „Gartentor“)

Am Tür-Video modul können 2 unabhängige Relais geschaltet und damit z.B.: Türen geöffnet werden. Um die Relais zu konfigurieren, öffnen Sie die Remote-Konfiguration des Tür-Video moduls in der ABUS CMS Software und wechseln zum Menü „Intercom“ / „IO in out“.

Unter „IO out“ können die jeweiligen Relais für DOOR 1 und DOOR 2 konfiguriert werden, bei Bedarf auch deaktiviert. Bei Deaktivierung Relais erscheint das „Schlüssel“-Symbol zum Tür-Öffnen weder in der ABUS Link Station App noch direkt am Monitor.

Hinweis: Es darf nur eines der beiden Relais auf „securityModule“ (Sicherheitsmodul TVHS10040/TVHS20340) stehen (**bis Firmware-Version V2.0.8 / V2.1.2 build 200410 - ab Firmware-Version V2.2.3 / V2.1.2 build 201029 automatische Erkennung**).

Schaltfläche / Anzeige	Beschreibung
Disable	Das Relais wird nicht verwendet und ausgeblendet
electricLock	Das interne Relais des Tür-Videomoduls wird verwendet
securityModule	Das externe Sicherheitsmodul TVHS10040/TVHS20340 wird verwendet. (Siehe Menüpunkt „Sicherheitsmodul“)

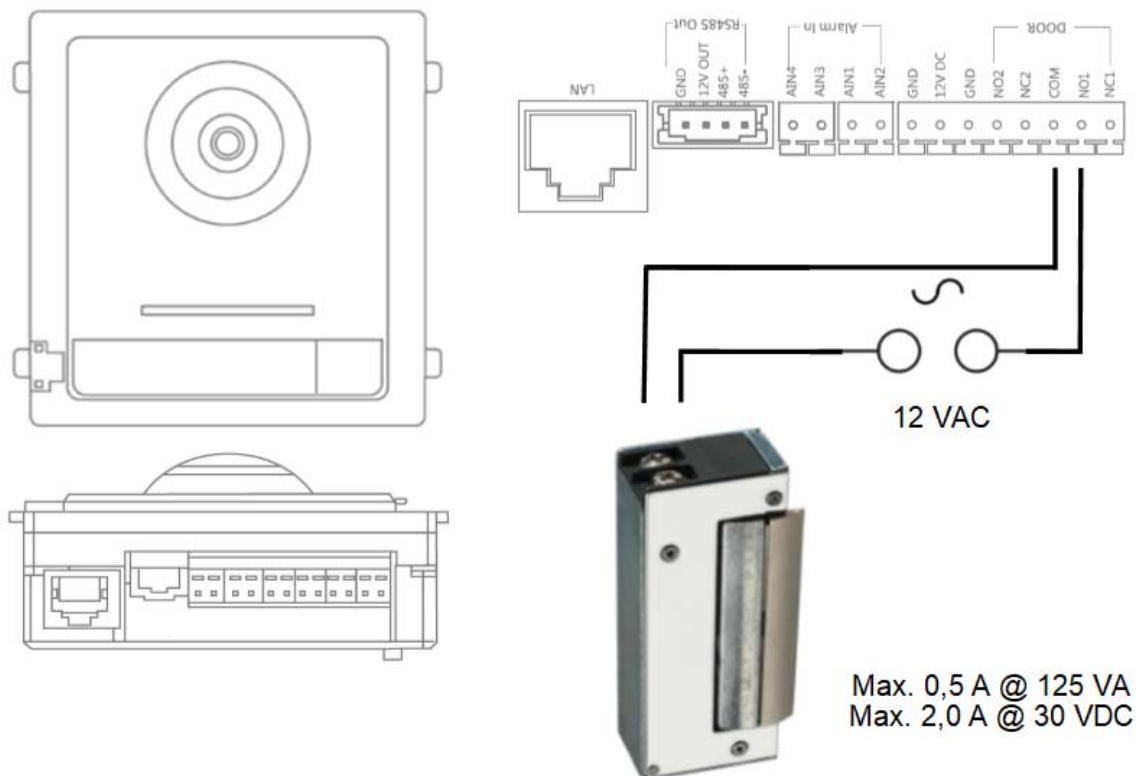

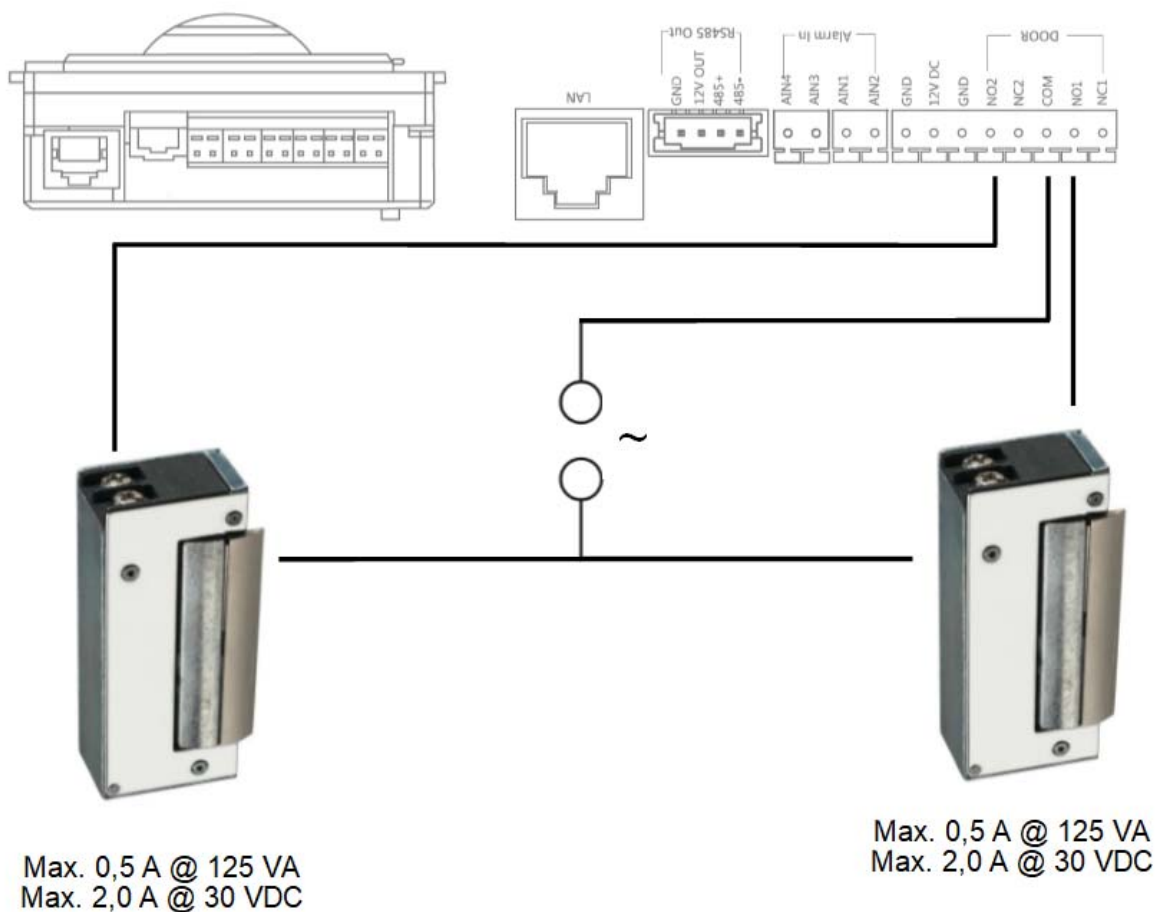

### 9.9 Einspielen eigener Klingeltöne in den Türstations-Monitor

Sie können eigene Klingeltöne im \*wav-Format über die ABUS CMS Software in ihren Monitor spielen. Hierfür öffnen Sie die Remote-Konfiguration des jeweiligen Monitors und wechseln unter „Intercom“ in das Menü „Ring import“. Wählen Sie hier einen freien Slot und laden Sie die \*WAV-Audiodatei hoch. Nach erfolgreichem Upload steht die Datei unter „Klingeltöne“ direkt am Monitor zur Verfügung.

**Achtung:** Ein im Monitor ausgewählter Klingelton kann nicht über die ABUS CMS gelöscht werden. Wählen Sie zuerst einen anderen Klingelton im Monitor aus und versuchen Sie dann erneut den Klingelton in der CMS zu löschen.

Bitte unbedingt die folgenden Parameter der WAV-Datei berücksichtigen:

Format: wav;  
 Maximale Größe: ≤300Kbit/s  
 Bitrate: 8KHz;  
 Kanal: Mono  
 Bitrate: 128Kbps

## Remote Configuration



- System
  - Device Information
  - General
  - Time
  - System Maintenance
  - User
  - RS485
- Intercom
  - ID Configuration
  - Time Parameters
  - Permission Password
  - Zone Alarm
  - IP Camera Information
  - Volume Input/Output
  - Ring Import
- Deploy Info
- Incoming Call Linkage
- Relay
- Network

### Ring Configuration

Index	Name	Size	Type	Add	Delete
1	Sprach...1_sd_2	185466	wav	+	×
2				+	×
3				+	×
4				+	×



## 9.10 ABUS CMS: Firmware Update der Moduvis-Komponenten durchführen

**Achtung:** Trennen Sie niemals die Spannungsversorgung oder das Netzkabel während eines Upgrades

**Achtung:** Führen Sie das Update nur in einer stabilen Netzwerkkumgebung (LAN) durch.

Es wird empfohlen, jedes Gerät nach einem Firmwareupdate auf Werkseinstellungen zu setzen.

Um ein Firmwareupdate auf einem Monitor oder das Videotürmodul aufzuspielen, wird die ABUS CMS Software benötigt. Verbinden Sie die Geräte mit dem Netzwerk und öffnen Sie die Remote-Konfiguration der jeweiligen Geräte.

Gehen Sie unter „Maintenance“ / „System Maintenance“ und wählen Sie die für das Gerät passende Datei aus.

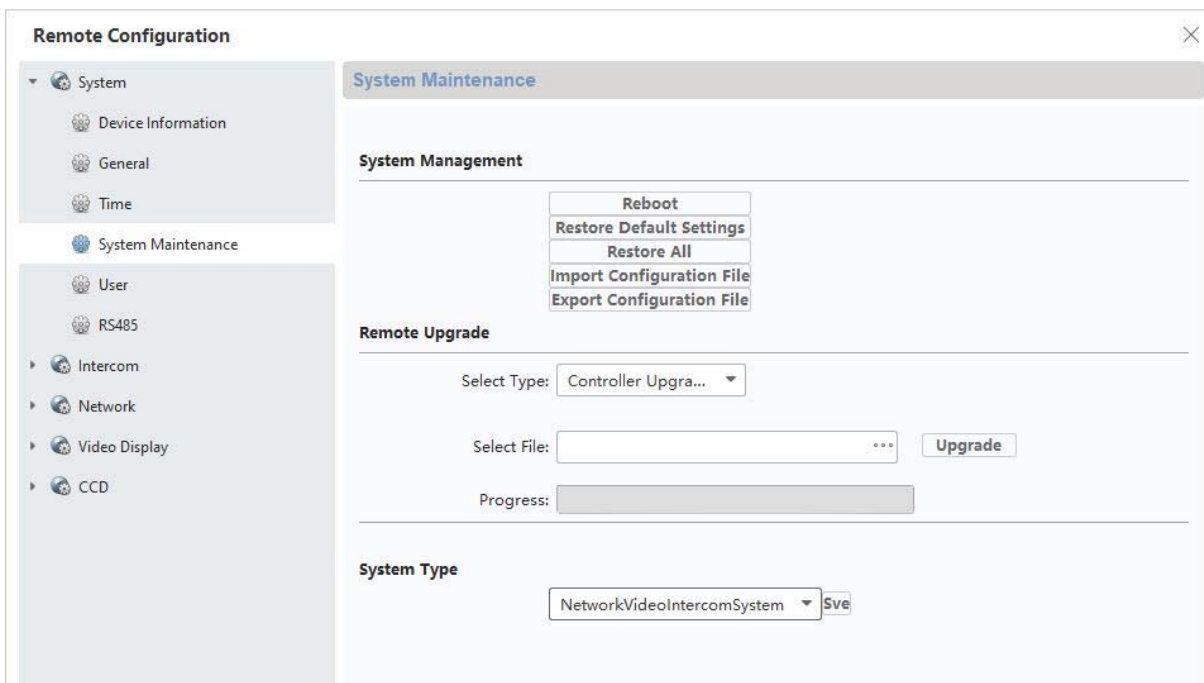

Beim Update eines Tür-Videomoduls (TVHS20000(S), TVHS20010(S)) muss „Controller-Upgrade“ ausgewählt sein.

Die aktuelle Firmware-Version kann mittels ABUS IP Installer oder in der CMS Software in der jeweiligen Gerätekonfiguration unter „Device Information“ ermittelt werden.

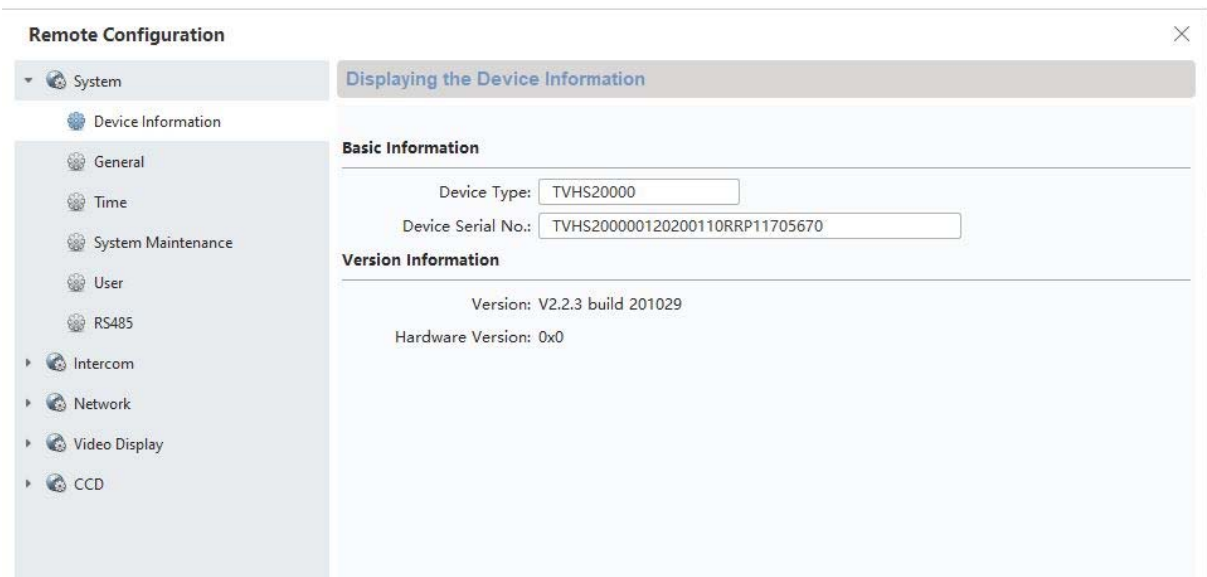

	<p>Nach einer Firmware-Aktualisierung müssen folgende Schritte durchgeführt werden:</p> <ol style="list-style-type: none"><li>1. Neustart des kompletten Systems durch entfernen der Versorgungsspannung</li><li>2. Alle aktualisierten Geräte auf Werkseinstellungen zurücksetzen („Restore all“)</li></ol>
--	--

## 9.11 ABUS CMS: Erweiterte Einstellungsmöglichkeiten

Im Folgenden findet sich eine kurze Übersicht über die Einstellungsmöglichkeiten via Remote-Konfiguration mit der ABUS CMS Software.

Jeder Monitor und jedes Tür-Videomodul erscheint als eigenständiges Netzwerkgerät im Netzwerk. Hierbei spielt es keine Rolle, ob das Gerät mittels 2-Draht oder PoE angebunden wird.

Remote Einstellungen von **TVHS2000(S)**, **TVHS20010(S)**, Video-Türmodul:

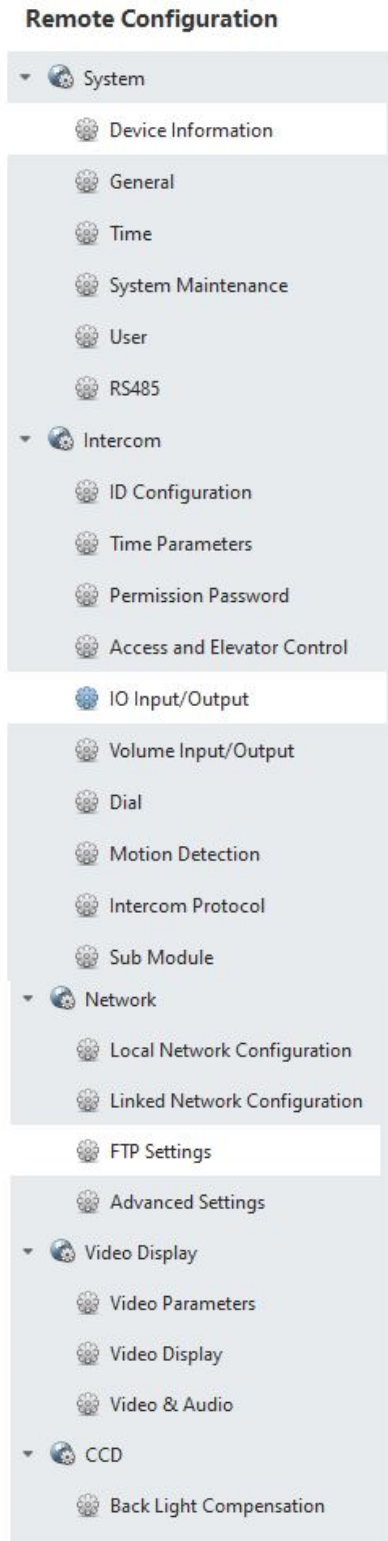

	Abschnitt „System“
Device Information	Generelle Informationen zu Firmware, Seriennummer
General	Gerätename und Geräte ID (nicht relevant für Türsprech-System)
Time	Einstellungen für Datum/Zeit, Sommerzeit und NTP Server
Maintenance	Wartungsmenü für Firmwareupdate, Werkseinstellungen setzen und Geräteneustart
User	Menü wird nicht verwendet
RS485	Menü wird nicht verwendet
	Abschnitt „Intercom“
ID Configuration	„Device-Typ“ muss immer auf „Outdoor unit“ stehen. Bitte verändern Sie keine Zahlenwerte der Einheiten „Period, Building, Unit, Floor“, da diese Werte hier nicht benötigt werden. Unter „No.:“ werden Nebeneingänge eingerichtet. 0 = Haupt-Türe, „1“ – „9“ = Nebeneingänge. Bitte im Kapitel „Einrichtung Nebeneingänge“ nachlesen. (Siehe <u>Installations- und Inbetriebnahmehinweise</u> )
Time Parameters	<b>Max talk time:</b> Maximale Gesprächsdauer eines angenommenen Anrufes. (90-120s) <b>Max Msg time:</b> Aufnahmedauer des Anrufbeantworters (30-60s)
Permission password	Hier können 3 zusätzliche PIN-Codes (6-stellig) für die Verwendung in Kombination mit TVHS20030 eingestellt werden.
Access and elevator control	<b>Door. No.:</b> Auswahl zwischen Relaisausgang 1 oder 2. <b>Open door time:</b> Legt die Zeit fest, wie lang das Relais den Tür-Öffner betätigen soll. (1-255s)

	„ <b>Door name</b> “ und „ <b>Card encrypt</b> “ wird nicht verwendet.
IO Input Output	Einstellungen der Digitalen Eingänge (für Not-Tür-Öffner) und der Relais für Tür-Öffner.
Volume Input Output	Einstellungen der Audioparameter des Video-Türmoduls. (Siehe <u>Installations- und Inbetriebnahmehinweise</u> )
Dial	Legt die Apartment-Zuweisung für die Klingeltaste am Tür-Video modul selbst fest. Von Werk aus steht unter „room No,“ eine „1“. Somit wird der Monitor mit der Apartment-Nummer 1 angerufen.
Motion detection	Einstellung der Bewegungserkennung in Verbindung mit ABUS NVR. (Bitte die Bewegungserkennung nur über den ABUS NVR direkt einrichtungen und konfigurieren)
Intercom Protocol	Wird nicht verwendet
Sub module	Übersicht über angeschlossene Erweiterungs module wie z.B.: TVHS20020(S), TVHS20030(S), TVHS20040(S)
	Abschnitt „Network“
Local NetCfg	IP Adresse des Video-Türmoduls. ( <b>IP Adresse, Subnetmaske, Standardgateway</b> )  <b>Port: 8000</b> wird für die Einbindung in einen ABUS NVR benötigt  <b>http Port</b> wird nicht benötigt da kein Webinterface vorhanden
Linked network configuration	Menüpunkt wird bei einem Haupt- Videotürmodul nicht verwendet.  <b>Main Outdoor IP Adress:</b> Wird bei der Zuweisung der Haupt-Türstation an einem Nebeneingang verwendet. (Siehe <u>Installations- und Inbetriebnahmehinweise</u> )
FTP Configuration	Wird nicht verwendet
Advanced settings	Konfiguration der DNS Server Adresse des Tür-Video moduls
	Abschnitt „Display“
Video parameters	Einstellungen der Bildparameter (Helligkeit, Kontrast, Sättigung)
Video Display	Einstellungn von OSD Einblendung (Kameraname, Datum, Zeit, Text Position)

Video&Audio	Einstellung der Streamparameter der Kamera des Video-Türmoduls. <b>Achtung:</b> Es wird nicht empfohlen Einstellungen zu verändern.
Back Light compensation	Einstellmöglichkeiten der BLC Funktion um Gegenlicht zu kompensieren.

Remote Konfiguration „ Monitor  
TVHS20200, TVHS20210, TVHS20220“:

System	<ul style="list-style-type: none"> <li>Device Information</li> <li>General</li> <li>Time</li> <li>System Maintenance</li> <li>User</li> <li>RS485</li> </ul>
Intercom	<ul style="list-style-type: none"> <li>ID Configuration</li> <li>Time Parameters</li> <li>Permission Password</li> <li>Zone Alarm</li> <li>IP Camera Information</li> <li>Volume Input/Output</li> <li>Ring Import</li> <li>Deploy Info</li> <li>Incoming Call Linkage</li> <li>Relay</li> </ul>
Network	<ul style="list-style-type: none"> <li>Local Network Configuration</li> <li>Linked Network Configuration</li> <li>Advanced Settings</li> <li>ABUS Link Station</li> </ul>

Device Information	Informationen wie „Firmware“, „Seriennummer“ etc.
General	Gerätename und Geräte ID (nicht relevant für Türsprech-System)
Time	Einstellungen für Datum/Zeit, Sommerzeit und NTP Server
Maintenance	Wartungsmenü für Firmwareupdate, Werkseinstellungen setzen und Gerätereustart
User	Wird nicht verwendet
RS485	Wird nicht verwendet
Abschnitt „Intercom“	
ID configuration	<p>Auswahl der Aparmentnummer (Wohnungsnummer) in der Betriebsart „Indoor Station“(Haupt-Monitor) Im Modus „Station Extension“ (Erweiterungsmonitor) wird die Nummer des Erweiterungsmonitors konfiguriert.</p> <p>Hinweis: Die Auswahl der Betriebsart „Hauptmonitor“ oder „Erweiterungsmonitor“ sowie die Zuweisungen der Nummern erfolgt in der Regel über das Menü der jeweiligen Monitore selbst. (z.B.: Im Einrichtungsprozess via Installations-Wizard)</p>
Time Parameters	<p>Einstellungen von Anrufdauer, Livebild-Anzeigedauer, Anruf-Weiterleitungsverzögerung, Klingeltondauer.</p> <p>Hinweis: Diese Einstellungen können auch direkt im Menü des Monitors verändert werden.</p>
Permission Password	Wird in der Remote Konfiguration des Monitors nicht verwendet.
Zone Alarm	Wird nicht verwendet
IP camera information	Hinzufügen von ABUS Netzwerkkameras. (Siehe Kompatibilitätsliste) Es können bis zu 16 ABUS Netzwerkkameras hinzugefügt und Live betrachtet werden. (Keine Wiedergabe oder Konfiguration der Kamera über die Türstation direkt möglich)

Volume Input Output	(Siehe <u>Installations- und Inbetriebnahmehinweise</u> )
Ring Import	Verwaltung eigener Klingeltöne (Siehe <u>Installations- und Inbetriebnahmehinweise</u> )
Deploy Info	Wird nicht verwendet
Incoming Call Linkage	Wird nicht verwendet
Relay	Wird nicht verwendet
	Abschnitt „Network“
Local NetCfg	IP Adresse des Monitors. ( <b>IP Adresse, Subnetmaske, Standardgateway</b> )  <b>Port: 8000</b> wird hier nicht benötigt  <b>http Port</b> wird nicht benötigt da kein Webinterface vorhanden
Linked network configuration	Zuweisung des Hauptmonitors and das Haupt-Türvideomodul. Im Falle eines Hauptmonitors wird hier die IP Adresse des Haupt-Türmoduls eingetragen. Der Eintrag „MainOutdoorUnit“ darf nicht verändert werden. <b>Hinweis:</b> Die Zuweisung von Tür-Videomodul an Monitor erfolgt in der Regel bereits bei der Einrichtung lokal am Monitor selbst.
Advanced settings	Konfiguration des DNS Servers vom Monitor.
ABUS Link Station	Konfiguration des Zugriffs via ABUS Link Station App. <b>Siehe Einstellungen ABUS Link Station-Dienst.</b> Die Verbindung mit der ABUS Link Station App kann einfach über die Oberfläche am Monitor selbst erfolgen.

### 9.12 Funktionsumfang MODUVIS und ABUS Link Station APP

Die MODUVIS Türsprechanlage kann in die ABUS Link Station APP eingebunden werden. Folgende Möglichkeiten stehen zur Verfügung:

- Verification Code ändern: Der Verification Code sollte als erstes im Menüpunkt „ABUS Link Station Dienst“ geändert werden. Klicken Sie dazu auf den aktuell angezeigten Code.
- Hinzufügen: Scannen des QR Codes und hinzufügen des Gerätes zur APP. Weiterhin ist die Eingabe des Verificaiton Codes nötig
- Gerät teilen: Die Türsprechanlage kann mit weiteren Benutzern geteilt werden. So haben mehrere Personen bzw. Apps Zugriff auf die Anlage.
- Pushmöglichkeiten: Beim Klingeln an der Türsprechanlage kann direkt oder verzögert die ABUS Link Station App angerufen werden. Der

Ruf kann über die App angenommen werden, und Gegensprechen mit dem Video der Türstation ist möglich. Bei eingeschränkter Empfangsqualität bzw. mobiler Bandbreite kann das Video deaktiviert werden und nur gesprochen werden.

- Tür öffnen: Relais 1 oder Relais 2 kann über die App geschaltet werden. Damit lassen sich z.B. elektrische Türöffner betätigen.
- Ereignislog: Die App verfügt über eine Nachrichtenseite mit Einträgen der letzten Klingelaktivitäten mit einem Ereignisbild.

### 9.13 Kompatibilität mit ABUS Produkten

Dieser Abschnitt geht auf ein mögliches Zusammenspiel mit anderen ABUS Produkten ein.

ABUS Produkt	Kompatibilität
Secvest	Nein
WAppLoxx	Relaisbeschaltung
WAppLoxx Pro	Relaisbeschaltung
ABUS IP Kameras	Siehe Kompatibilitätsliste <a href="http://www.abus.com">www.abus.com</a> , <a href="http://www.abus-sc.de">www.abus-sc.de</a>
ABUS NVR	Einbindung des Videos der Türstation, siehe Abschnitt 9.14
ABUS Link Station APP	Aufruf des Live Bildes der Türstation Push Nachricht bei Klingeln

### 9.14 Einbindung Video-Türmodul in ABUS NVR

Das Videobild des Video-Türmoduls kann auch in einem ABUS NVR eingebunden werden. Dabei wird das Video über das RTSP Protokoll abgegriffen, welches ausschließlich eine Daueranzeige oder Daueraufzeichnung möglich macht (keine Bewegungserkennung oder andere Ereignisaufnahmetypen).

	Bitte beachten Sie die am Installationsort vorherrschenden Datenschutzbestimmungen!
---	---

Folgende Schritte sind für die Einbindung nötig:

1. Erstellung eines benutzerdefinierten Protokolls im Kamera-Management des ABUS NVRs.
2. Folgende Streamdetails sind zu verwenden:  
 Protokoll: RTSP  
 Transfer Protokoll: Automatic  
 Port: 554 (Standardport)  
 Streampfad: Streaming/Channels/101 (Main Stream)  
                   Streaming/Channels/102 (Sub Stream)
3. Beim Hinzufügen eines neuen Kanals zum NVR wird dann dieses Benutzerdefinierte Protokoll für das Video-Türmodul ausgeählt.  
 Benutzername („admin“) und Passwort sind in der Regel gleich dem Türstationmonitor. Falls das Passwort über die CMS Software geändert wurde, dann muss dieses geänderte Passwort verwendet werden.

### 9.15 "Not-Tür-Öffner" Taster an Tür-Videomodul

An das Tür-Videomodul kann über den Alarm-Eingang 3 (AIN 3 = Relais 1) und Alarm-Eingang 4 (AIN 4 = Relais 2) direkt ein Taster/Schalter angebracht werden, welcher bei Betätigung das Tür-Relais schaltet.

Um den Alarmeingang 3 (AI3 und AI4) zu aktivieren, öffnen Sie die Remote-Konfiguration des jeweiligen Tür-Videomoduls mit der ABUS CMS Software und setzen AI3 auf „openDoorBtn“

Der AIN3 des Tür-Videomoduls öffnet nun die Tür des Relais 1  
Der AIN4 des Tür-Videomoduls öffnet nun die Tür des Relais 2

Aus Sicherheitsgründen ist diese Funktion bei Auslieferung deaktiviert.

The screenshot shows the 'IO Input/Output' configuration window. It is divided into two sections: 'IO Input' and 'IO Output'. In the 'IO Input' section, 'IO Input No:' is set to 'AI3' and 'Input:' is set to 'Door Switch'. In the 'IO Output' section, 'IO Output No:' is set to 'DOOR1' and 'Output:' is set to 'Electric Lock'. A 'Save' button is located at the bottom of the configuration area.

Section	Parameter	Value
IO Input	IO Input No:	AI3
	Input:	Door Switch
IO Output	IO Output No:	DOOR1
	Output:	Electric Lock



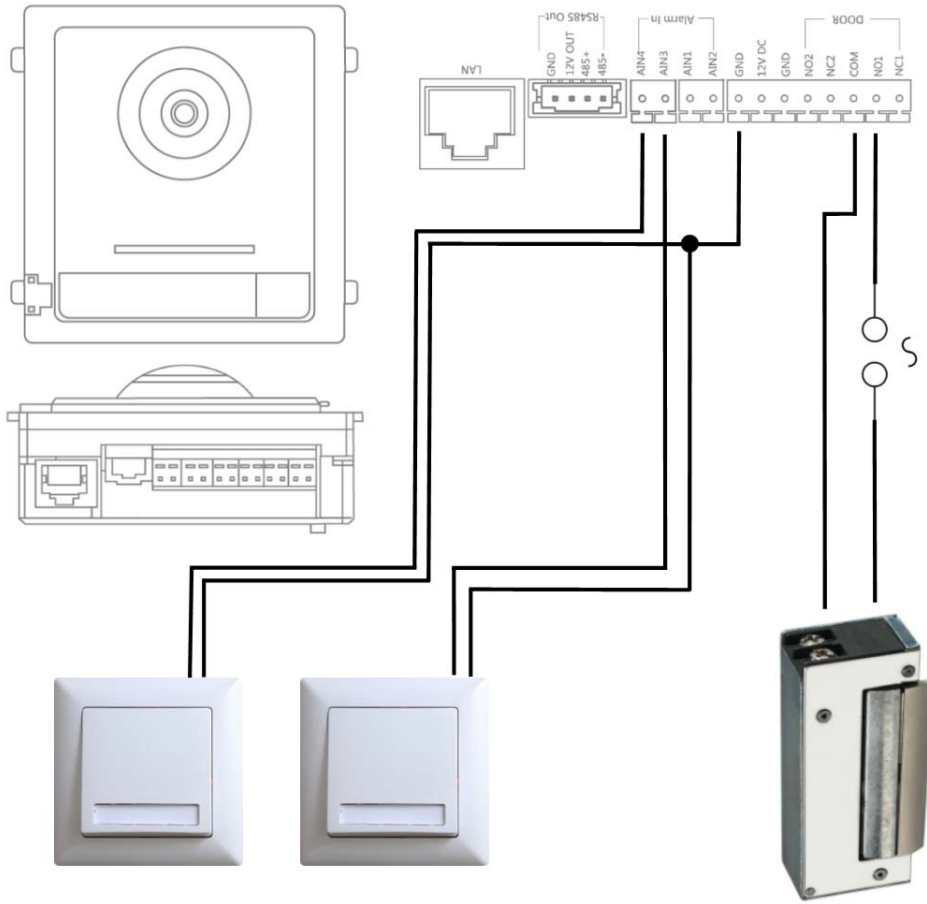

Max. 2A @ 30 VDC  
 Max. 0.5A @ 125 VAC

## 9.16 Relaisbeschaltung

Die Relais von Tür-Video-Modul (TVHS20000(S), TVHS20010(S)), Sicherheits-Modul TVHS10040/TVHS20340 sowie Monitore TVHS202x0 dürfen mit maximal max. 2A 30VDC / 0.5A 125AC belastet werden. Eine Überlastung hat ein Defekt des Gerätes zur Folge.

Bitte ermitteln Sie unbedingt die Stromaufnahme Ihres vorhandenen Türöffners / Motorschloss. Falls die zulässige Stromstärke überschritten wird, empfehlen wir ein externes Relais anzukoppeln.

Das Türvideo-Modul hat einen separaten 12V DC Spannungsausgang. Hiermit kann ein externes Hilfs-Relais ohne weitere Spannungsversorgung direkt angeklemt werden.

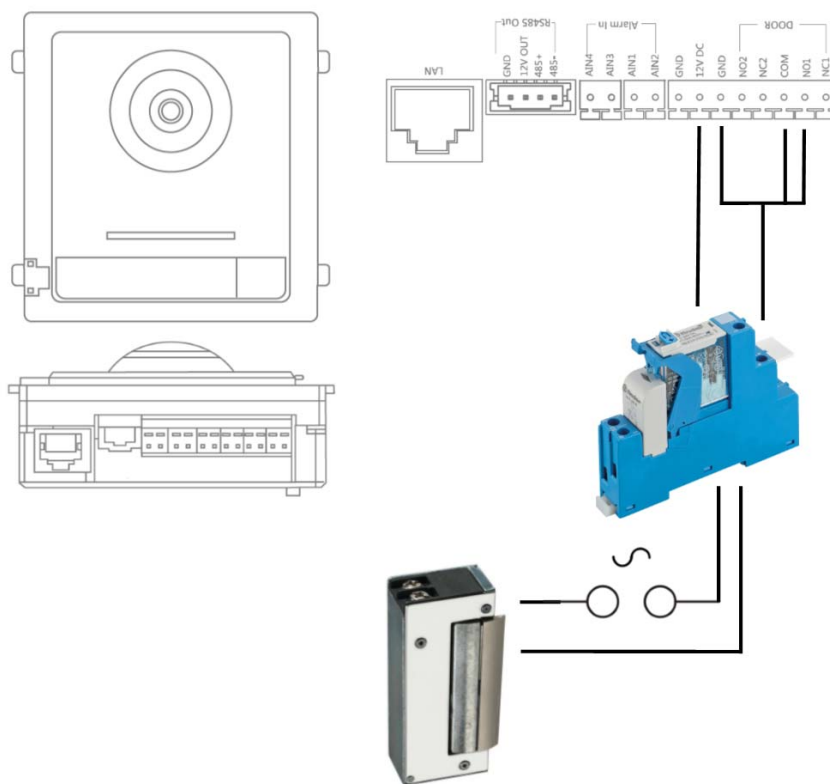

Hutschienen Relais:

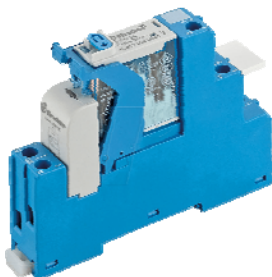

Beispiel: Fertig aufgebaute 12V Relais-Platine



## 9.17 Anleitung zum Ausmessen des vorhandenen Türöffners

Falls Sie einen bereits vorhandenen Türöffner ansteuern wollen und hier keinerlei Informationen über den Stromverbrauch haben, muss vor dem Anschließen an das Relais des Tür-Videomoduls ermittelt werden, ob die maximale Stromaufnahme das Relais nicht überlastet.

Messen Sie hierfür mit einem Multimeter im Strom-Messbereich (A) in Reihe geschaltet die Stromaufnahme des Türöffners.

## 9.18 Anwendungsbeispiel „Videomodul vor jeder Wohnungstür“

Oft besteht der Wunsch vor jeder Wohnungstür in einem Mehrparteienhaus ebenfalls ein Videomodul zu platzieren, um auch dort ein 180° Video vom Bereich vor der Wohnungstür zu bekommen (Türspione sind meist recht spitzwinklig in ihrem Blickfeld).

Für bis zu 16 Wohnungstüren kann dies über die Funktion „Nebeneingang“ im Videomodul programmiert werden.

### LAN Variante

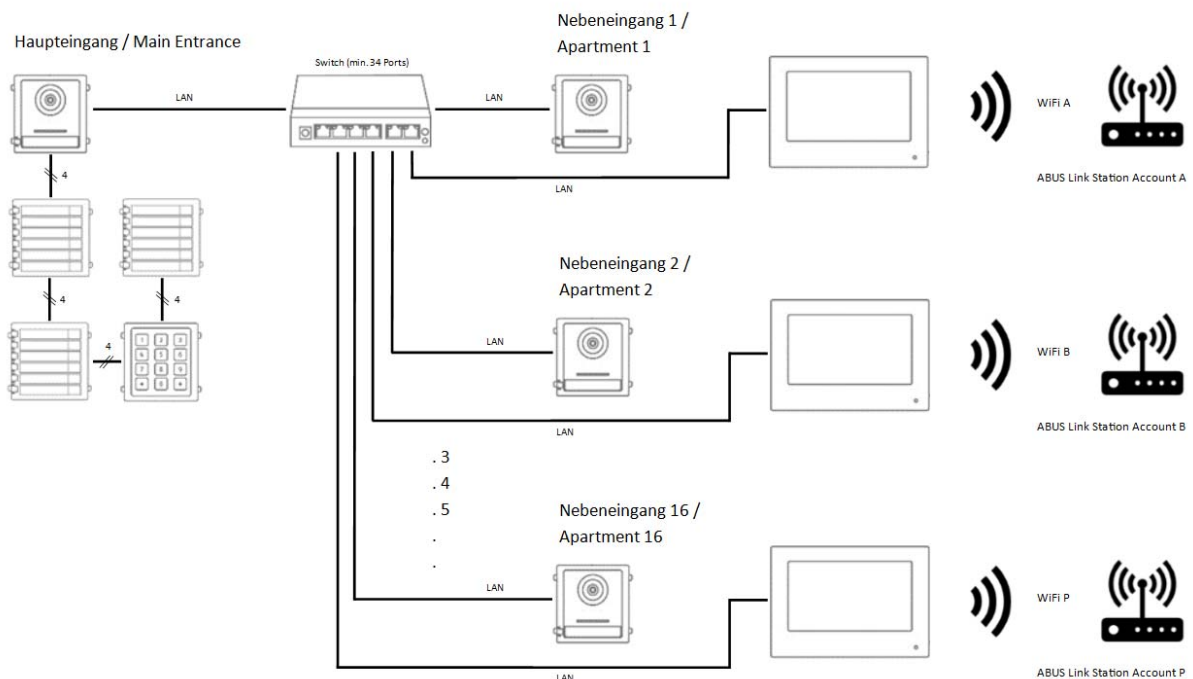

### 2-Draht Variante

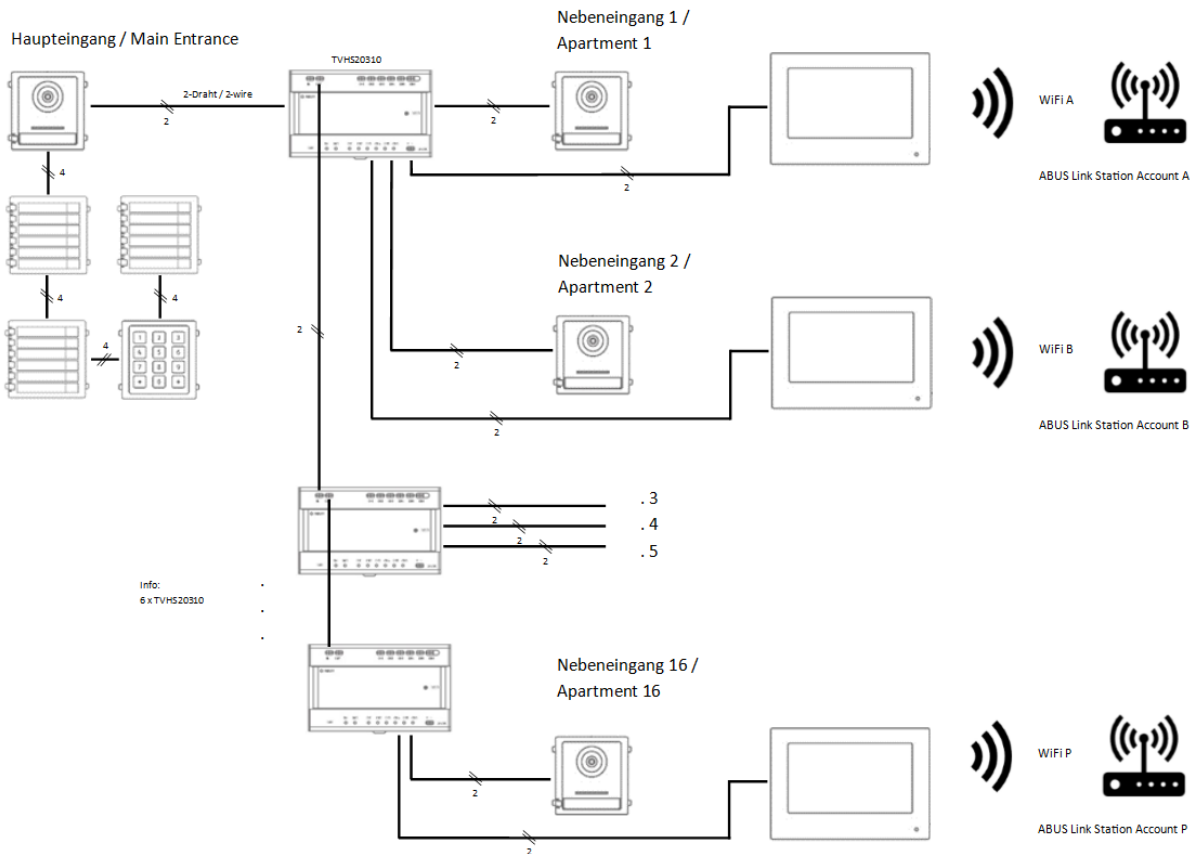

### Remote Configuration

- System
  - Device Information
  - General
  - Time
  - System Maintenance
  - User
  - RS485
- Intercom
  - ID Configuration
  - Time Parameters
  - Permission Password
  - Access and Elevator Control
  - IO Input/Output
  - Volume Input/Output
  - Dial
  - Motion Detection
  - Intercom Protocol
  - Sub Module
- Network
- Video Display
- CCD

#### Configuring the Room Numbers

**Device No. Configuration**

Device Type:

Project No.:

Community No.:

Building No.:

Floor No.:

No.:

**Reboot**

Master Outdoor Device to Slave Device will cause the device to reboot, Are you sure?

**Remote Configuration** ✕

- Time
- System Maintenance
- User
- RS485
- ▼ Intercom
  - ID Configuration
  - Time Parameters
  - Access and Elevator Control
  - IO Input/Output
  - Volume Input/Output

**Configuring the Network and Sip Parameters**

**Linked Network Configuration**

Device Type: Door Station

Master Station IP Address: 0.0.0.0

(Main) Door Station IP Address: 192.168.0.45

SIP Server IP Address: 0.0.0.0

Security Control Panel IP Address: 0.0.0.0

Security Control Panel Port No.: 0

Save

**Remote Configuration** ✕

- ▼ System
  - Device Information
  - General
  - Time
  - System Maintenance
  - User
  - RS485
  - ▼ Intercom
    - ID Configuration
    - Time Parameters
    - Permission Password
    - Access and Elevator Control
    - IO Input/Output
    - Volume Input/Output
  - Dial
- Motion Detection
- Intercom Protocol
- Sub Module
- ▶ Network
- ▶ Video Display
- ▶ CCD

**Configuring the Key Call Room Parameters**

**Dial**

Number: 1

Room No.: 1

Quick Press for Calling Center

Save

### 9.19 Anwendungsbeispiel „Individueller WiFi Zugriff“

In einem Mehrparteienhaus besteht oft nicht die Möglichkeit eines zentralen Internetanschlusses für alle Wohneinheiten. Jede Wohneinheit hat ggf. ihren eigenen Internetanschluss.

Über die WiFi Funktion des Hauptmonitors kann eine Verbindung zum kundenspezifischen Internetanschluss hergestellt werden.

Somit besteht dann auch ein Zugang zur ABUS Link Station Funktion mit Pushbenachrichtigung bei Klingelruf individuell für jede Wohneinheit.

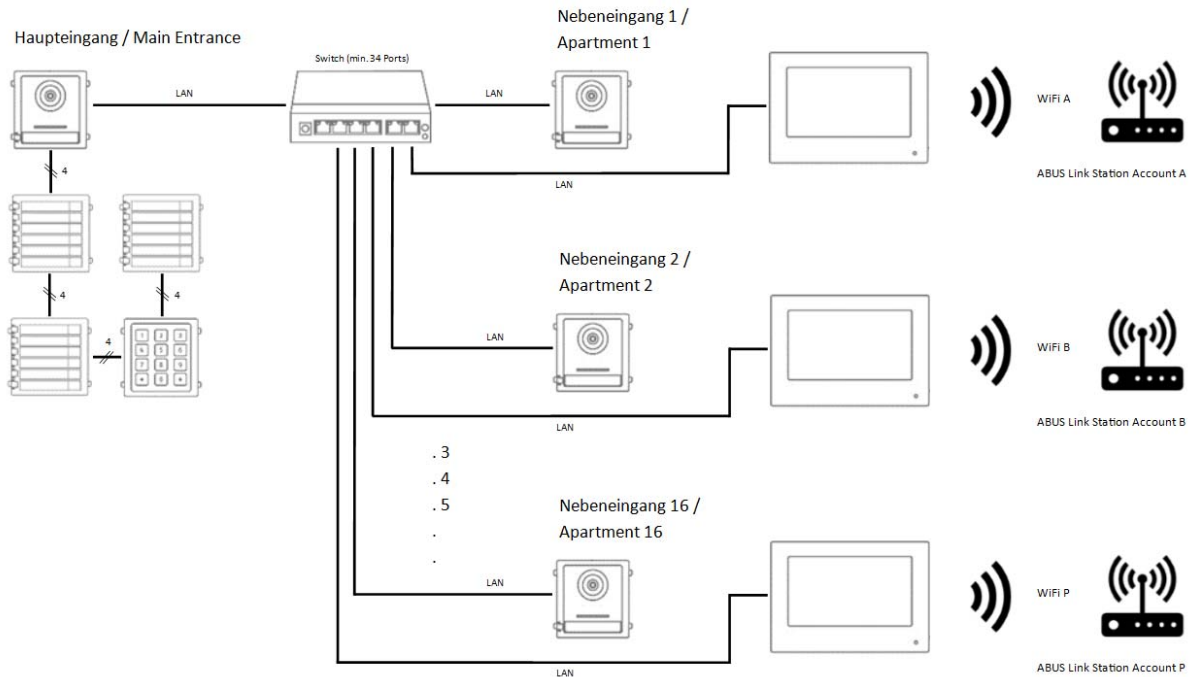

Wlan-Einstellungen		
	<input type="checkbox"/>	
MAX_MUSTERWLAN		

## 10. Leitfaden zur Verdrahtung (2-Draht)

Ein Dokument mit weiteren Hinweisen zur Verdrahtung der 2-Draht Türsprechanlage finden Sie unter [www.abus.com](http://www.abus.com), z.B. am Produkt TVHS20010:

[https://www.abus.com/var/ImagesPIM/d110001/medias/docus/25/Moduvis\\_Verkabelung\\_Wirring\\_2wire\\_V1.1.pdf](https://www.abus.com/var/ImagesPIM/d110001/medias/docus/25/Moduvis_Verkabelung_Wirring_2wire_V1.1.pdf)

## MODUVIS Door intercom TVHS20XXX(S)

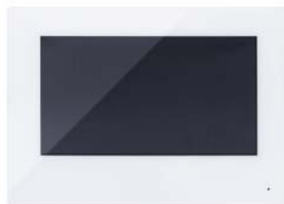

## User manual

Version 06/2021 (V1.2)



*English translation of the original German user manual. Retain for future reference.*



## **EN Introduction**

Dear Customer,

Thank you for purchasing this product.

### TVHS20000 / TVHS20000S

The device complies with the requirements of the following EU directives: EMC Directive 2014/30/EU and the RoHS Directive 2011/65/EU.

### TVHS20010 / TVHS20010(S)

The device complies with the requirements of the following EU directives: EMC Directive 2014/30/EU and the RoHS Directive 2011/65/EU.

### TVHS20020 / TVHS20020(S)

The device complies with the requirements of the following EU directives: EMC Directive 2014/30/EU and the RoHS Directive 2011/65/EU.

### TVHS20030 / TVHS20030S

The device complies with the requirements of the following EU directives: EMC Directive 2014/30/EU and the RoHS Directive 2011/65/EU.

### TVHS20040

The device complies with the requirements of the following EU directives: EMC Directive 2014/30/EU and the RoHS Directive 2011/65/EU.

### TVHS20200

ABUS Security-Center hereby declares that the device complies with Radio Equipment Directive (RED) 2014/53/EU. Additionally, these devices comply with the requirements of the following EU directives: EMC Directive 2014/30/EU and the RoHS Directive 2011/65/EU. The full EU Declaration of Conformity text can be found at the following internet addresses:  
[www.abus.com/product/TVHS20200](http://www.abus.com/product/TVHS20200)

### TVHS20210

ABUS Security-Center hereby declares that the device complies with Radio Equipment Directive (RED) 2014/53/EU. Additionally, these devices comply with the requirements of the following EU directives: EMC Directive 2014/30/EU and the RoHS Directive 2011/65/EU. The full EU Declaration of Conformity text can be found at the following internet addresses:  
[www.abus.com/product/TVHS20210](http://www.abus.com/product/TVHS20210)

### TVHS20220

ABUS Security-Center hereby declares that the device complies with Radio Equipment Directive (RED) 2014/53/EU. Additionally, these devices comply with the requirements of the following EU directives: EMC Directive 2014/30/EU and the RoHS Directive 2011/65/EU. The full EU Declaration of Conformity text can be found at the following internet addresses:  
[www.abus.com/product/TVHS20220](http://www.abus.com/product/TVHS20220)

### TVHS10040 / TVHS20340

The device complies with the requirements of the following EU directives: EMC Directive 2014/30/EU and the RoHS Directive 2011/65/EU.

To ensure this remains the case and to guarantee safe operation, it is your obligation to observe these operating instructions.

Please read the entire user guide carefully before commissioning the product, and pay attention to all operating instructions and safety information.

**All company names and product descriptions are trademarks of the corresponding owner.  
All rights reserved.**

**If you have any questions, please contact your specialist installation contractor or specialist dealer.**



#### **Disclaimer**

This user guide has been produced with the greatest of care. Should you discover any missing information or inaccuracies, please let us know about them.

ABUS Security-Center GmbH & Co. KG does not accept any liability for technical and typographical errors, and reserves the right to make changes to the product and user manuals at any time and without prior warning.

ABUS Security-Center GmbH is not liable or responsible for any direct or indirect damage resulting from the installation, performance and use of this product. No guarantee is made for the contents of this document.

## Important safety information



**All guarantee claims are invalid in the event of damage caused by non-compliance with this user manual. We cannot be held liable for resulting damage.**



**We cannot be held liable for material or personal damage caused by improper operation or non-compliance with the safety information. All guarantee claims are void in such cases.**

**Dear customer,**

**The following safety information and hazard notes are not only intended to protect your health, but also to protect the device from damage. Please read the following points carefully:**

- There are no components inside the product that require maintenance by the operator. Opening or dismantling the product invalidates the CE certification and guarantee claims/warranty.
- The product may be damaged if it is dropped, even from a low height.

Avoid the following adverse conditions during operation:

- Moisture or excess humidity
- Extreme heat or cold
- Direct sunlight
- Dust or flammable gases, vapours or solvents
- Strong vibrations
- Strong magnetic fields (e.g. next to machines or loudspeakers)
- The camera must not be installed on unstable surfaces.

General safety information:

- Do not leave packaging material lying around. Plastic bags, sheeting, polystyrene packaging, etc. can pose a danger to children if played with.
- The video surveillance camera contains small parts which could be swallowed and must be kept out of the reach of children for safety reasons.
- Do not insert any objects into the device through the openings.
- Only use replacement devices and accessories that are approved by the manufacturer. Do not connect any non-compatible products.
- Please pay attention to the safety information and user manuals for the other connected devices.
- Check the device for damage before putting it into operation. Do not put the device into operation if you identify any damage.
- Adhere to the normal voltage limits specified in the technical data. Higher voltages could destroy the device and pose a health risk (electric shock).



When installing the device in an existing video surveillance system, ensure that all devices have been disconnected from the mains power circuit and low-voltage circuit.



If in doubt, have a specialist technician carry out assembly, installation and connection of the device. Improper or unprofessional work on the power supply system or domestic installation puts both you and other persons at risk. Connect the installations so that the mains power circuit and low-voltage circuit always run separately from each other. They should not be connected at any point or become connected as a result of a malfunction.

# Contents

<b>1.</b>	<b>INTENDED USE</b> .....	<b>84</b>
<b>2.</b>	<b>EXPLANATION OF SYMBOLS</b> .....	<b>84</b>
<b>3.</b>	<b>SYSTEM OVERVIEW</b> .....	<b>85</b>
3.1	2-WIRE VARIANT .....	87
3.1.1	COMPONENTS.....	87
3.1.2	RECOMMENDED CABLE TYPES .....	88
3.2	IP NETWORK VARIANT .....	88
3.2.1	COMPONENTS.....	88
3.3	INSTALLATION COMPONENTS .....	89
3.4	SYSTEM VARIANTS .....	90
<b>4.</b>	<b>START-UP</b> .....	<b>95</b>
4.1	WIRING .....	95
4.1.1	INSTALLATION HEIGHT .....	95
4.2	ACTIVATION OPTIONS / INITIAL PASSWORD ASSIGNMENT .....	96
4.2.1	ACTIVATION VIA DOOR STATION MONITOR .....	96
4.2.2	ACTIVATION VIA IP NETWORK.....	100
4.2.3	PASSWORD RESET FOR MONITOR/VIDEO DOOR MODULE .....	100
<b>5.</b>	<b>MONITOR OPERATION (2-WIRE &amp; IP)</b> .....	<b>101</b>
5.1	LIVE IMAGE .....	101
5.2	MAIN PAGE OVERVIEW.....	102
5.2.1	MENU ITEM: CALL SETTINGS .....	107
5.2.2	WI-FI SETTINGS .....	111
5.2.3	FLOOR BUTTONS.....	112
5.2.4	OTHER SETTINGS .....	113
5.2.4.1	CONFIGURATION – LOCAL INFORMATION .....	113
5.2.4.2	CONFIGURATION – NETWORK SETTINGS .....	117
5.2.4.3	CONFIGURATION – DEVICE MANAGEMENT .....	118
5.2.4.4	CONFIGURATION – DEFAULT SETTINGS .....	120
5.2.5	RELAY CONFIGURATION.....	120
5.2.6	MICROSD CARD .....	122
5.2.7	LOCK SCREEN.....	122
5.2.8	DEVICE INFORMATION .....	122
5.2.9	TIME SETTING .....	122
5.2.10	RESTART DEVICE .....	122
5.2.11	PASSWORD SETTINGS (PIN CODE).....	123
5.2.12	SYSTEM LANGUAGE.....	124
5.2.13	BRIGHTNESS SETTING .....	124
5.2.14	FLOOR BUTTON.....	124
5.2.15	OPEN SOURCE LICENCE INFORMATION.....	124
<b>6.</b>	<b>MAINTENANCE AND CLEANING</b> .....	<b>125</b>
6.1	FUNCTION TEST.....	125
6.2	CLEANING .....	125
<b>7.</b>	<b>DISPOSAL</b> .....	<b>125</b>
<b>8.</b>	<b>OPEN SOURCE LICENCE INFORMATION</b> .....	<b>125</b>
<b>9.</b>	<b>INSTALLATION AND OPERATING INFORMATION</b> .....	<b>126</b>
9.1	USING THE SECURITY MODULE (TVHS10040).....	126
9.2	SETTING UP BACK DOORS .....	128

9.3	SETTING UP EXTENDED CALL BUTTONS (TVHS20020) FOR MULTI-FAMILY HOMES .....	129
9.4	ADJUSTING THE VOLUME ON THE DOOR VIDEO MODULE (TVHS20000(S), TVHS20010(S)).....	133
9.5	CONNECTING AN EXISTING DOORBELL .....	134
9.6	CONNECTING EXISTING DOOR OPENERS TO THE DOOR STATION MONITOR .....	134
9.7	CONNECTING FLOOR CALL BUTTONS TO THE MAIN MONITOR .....	135
9.8	CONNECTING ELECTRICAL DOOR OPENERS TO THE VIDEO MODULE (INCLUDING "GARDEN GATE")...	136
9.9	PLAYS YOUR OWN RING TONES IN THE DOOR STATION MONITOR .....	138
9.10	ABUS CMS: PERFORM FIRMWARE UPDATE FOR MODUVIS COMPONENTS.....	140
9.11	ABUS CMS: ADVANCED SETTING OPTIONS.....	142
9.12	MODUVIS AND ABUS LINK STATION APP RANGE OF FUNCTIONS.....	146
9.13	COMPATIBILITY WITH ABUS PRODUCTS .....	146
9.14	CONNECTING THE VIDEO DOOR MODULE TO ABUS NVR.....	146
9.15	"EMERGENCY DOOR OPENER" BUTTON ON DOOR VIDEO MODULE .....	147
9.16	RELAY CONNECTION.....	149
9.17	INSTRUCTIONS FOR MEASURING THE CURRENT DOOR OPENER.....	150
9.18	APPLICATION EXAMPLE "VIDEO MODULE IN FRONT OF EVERY APARTMENT DOOR" .....	150
9.19	APPLICATION EXAMPLE "INDIVIDUAL WIFI ACCESS" .....	153
<b>10.</b>	<b>WIRING GUIDELINES (2-WIRE).....</b>	<b>154</b>

## 1. Intended use

This MODUVIS door intercom is a two-way communication system with a video display of the door area. The system can be used for a single or multi-family home. With extension monitors in a living unit, the system can also be used as a two-way communication system (without video) within the home.

The MODUVIS door intercom is not a video surveillance system, nor may it be used as one.



Use of this product for any other purpose than that described may lead to damage to the product and other hazards. All other uses are not as intended and will result in the invalidation of the product guarantee and warranty. No liability can be accepted as a result. This also applies to any alterations or modifications made to the product.

Read the operating instructions fully and carefully before using the product. The operating instructions contain important information on installation and operation.

## 2. Explanation of symbols



The triangular high voltage symbol is used to warn of the risk of injury or health hazards, e.g. caused by electric shock.



The triangular warning symbol indicates important notes in this user guide which must be observed.



This symbol indicates special tips and notes on the operation of the unit.

### 3. System overview

This door intercom is also available with two different wiring technologies:

**2-wire variant:** Communication and power supply are transmitted through 2 wires (1 pair). The wiring is star-shaped, with the central point a 2-wire distributor. A basic system consists of the 2-wire distributor, 2-wire monitor and 2-wire video module.

**IP variant:** Communication and power supply are transmitted through Ethernet (network) cables. The components support power over Ethernet (PoE) (optional 12 VDC) The wiring is star-shaped, with the (PoE) switch at the central point. A basic system consists of the IP monitor and IP video module.

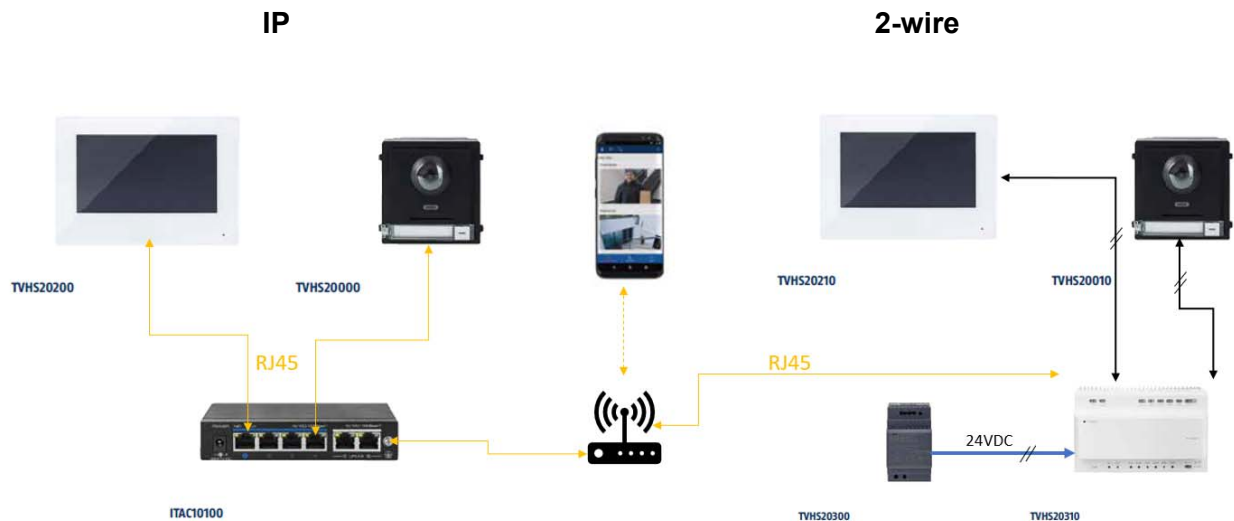

**i Both system variants can be combined with one another. This allows for optimal adaptation to the building conditions present.**

Examples of combined systems:

This example shows the mixed operation of a main monitor via 2-wire and an extension monitor via WiFi.

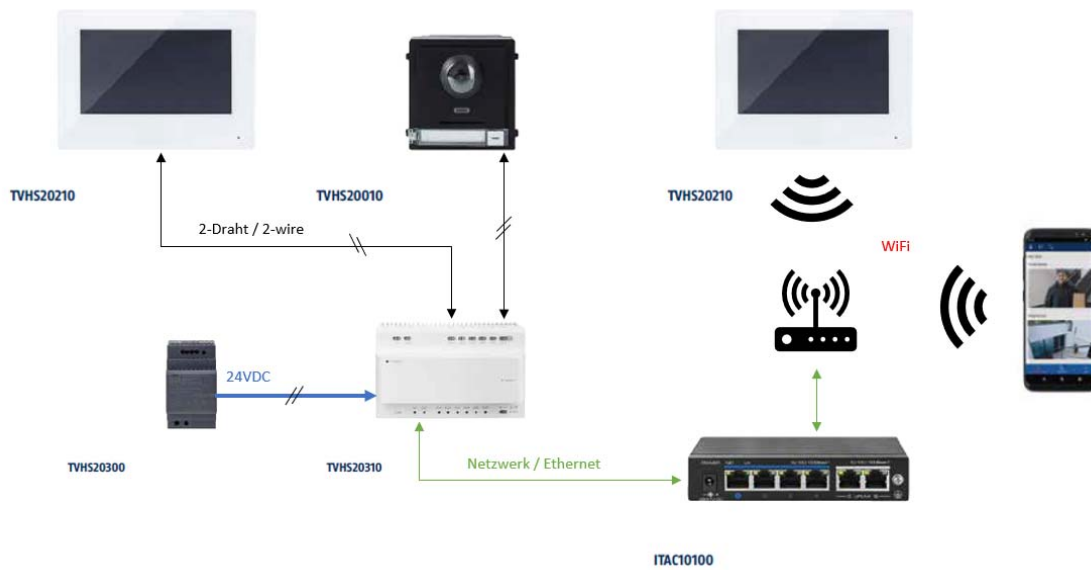



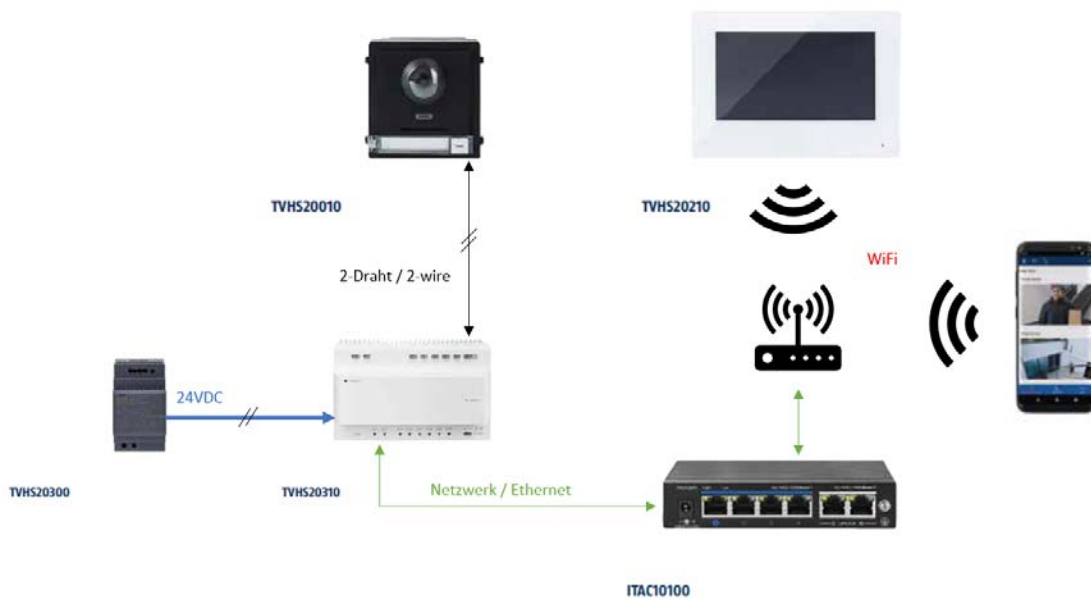





This example shows the mixed operation of a video door module via 2-wire with a main monitor via WiFi.

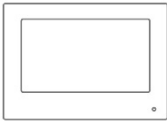

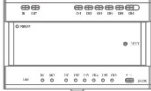

### 3.1 2-wire variant

#### 3.1.1 Components

<p>TVHS20210</p>  <p>2-wire monitor</p>	<p>TVHS20010 / TVHS20010S</p>  <p>2-wire video module</p>	<p>TVHS20310</p>  <p>2-wire distributor</p>
<p>TVHS20020 / TVHS20020S</p>  <p>Bell push button (6 buttons)</p>	<p>TVHS20030 / TVHS20030S</p>  <p>Numeric keypad</p>	<p>TVHS20040</p>  <p>Information module</p>
<p>TVHS20300</p>  <p>24 VDC power supply unit for hat rail</p>	<p>TVHS10040 / TVHS20340</p>  <p>Security module</p>	

### 3.1.2 Recommended cable types

Select the type of cable based on the distance between the video module, distributor and monitor.

2-wire video module (TVHS20010 / TVHS20010S)





2-wire monitor (TVHS20210)

2-wire distributor (TVHS20310)

Cable type	24AWG (10 $\Omega$ per 100m)	20AWG (7 $\Omega$ per 100m)	18AWG (4 $\Omega$ per 100m)
<b>Cable length</b>			
TVHS20310 / TVHS20310	Max. 60 m	Max. 60 m	Max. 60 m
TVHS20010(S) / TVHS20310	Max. 35 m	Max. 60 m	Max. 60 m
TVHS20210 / TVHS20310	Max. 35 m	Max. 60 m	Max. 60 m







### 3.2 IP network variant

#### 3.2.1 Components

TVHS20200 / TVHS20220 " data-bbox="185 575 290 630"/> IP 7"/"10" PoE monitor	TVHS20000 / TVHS20000S  IP video module	TVHS20020 / TVHS20020S  Bell push button (6 buttons)
TVHS20030 / TVHS20030S  Numeric keypad	TVHS20040  Information module	TVHS10040 / TVHS20340  Security module

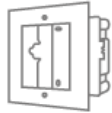
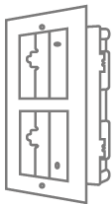
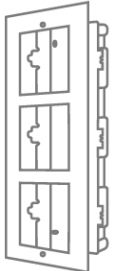
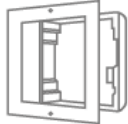
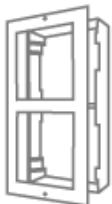

### 3.3 Installation components

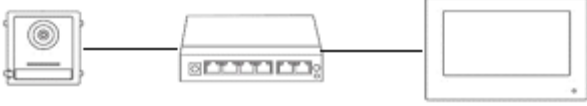
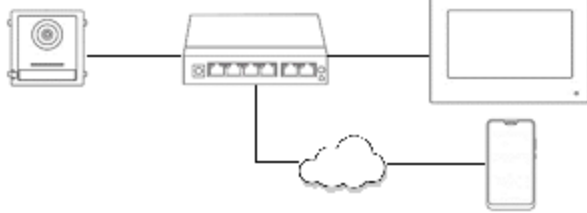
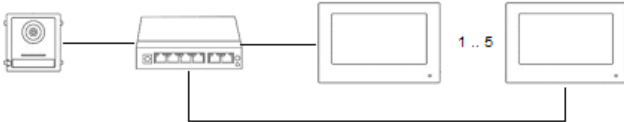
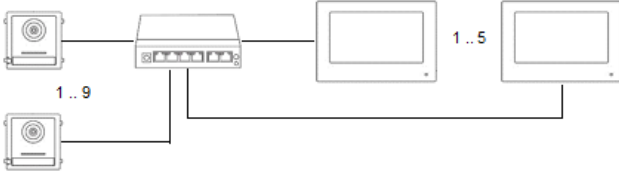
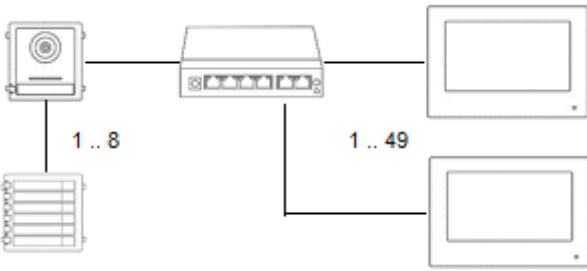

These available installation components can be used for either the 2-wire or the IP variant of the Moduvis video door intercom

<p>TVHS20050</p>  <p>Blank module aperture</p>	<p>TVHS20060</p>  <p>Aperture for unused call button</p>	<p>TVHS20100(S)</p>  <p>Frame for 1 module flush mounting</p>
<p>TVHS20110(S)</p>  <p>Frame for 2 modules flush mounting</p>	<p>TVHS20120(S)</p>  <p>Frame for 3 modules flush mounting</p>	<p>TVHS10130(S)</p>  <p>Frame for 1 module on-wall mounting</p>
<p>TVHS10140(S)</p>  <p>Frame for 2 modules on-wall mounting</p>	<p>TVHS10150(S)</p>  <p>Frame for 3 modules on-wall mounting</p>	<p>TVHS20160</p>  <p>Outdoor housing for frame on-wall mounting (1 module)</p>
<p>TVHS20170</p>  <p>Outdoor housing for frame on-wall mounting (2 modules)</p>	<p>TVHS20180</p>  <p>Outdoor housing for frame on-wall mounting (3 modules)</p>	

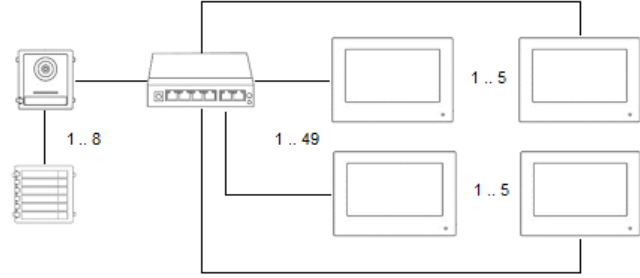
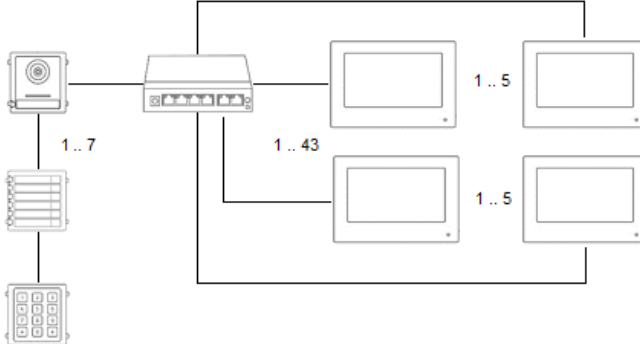
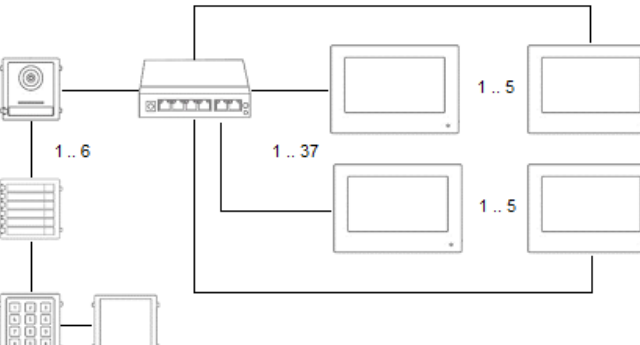
### 3.4 System variants

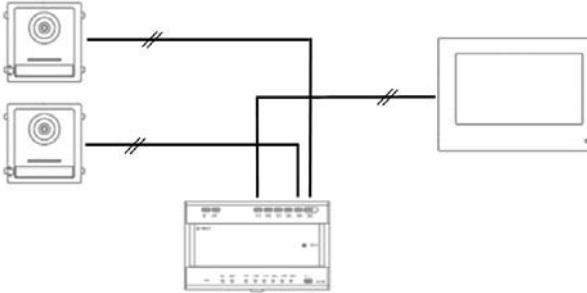
#	Technology / wiring	System configuration	Application example
1	IP		Single-family home
2	IP		Single-family home with app access
3	IP		Single-family home with interior extension monitors
4	IP		Single-family home with interior extension monitors and back doors
5	IP		Multiple dwelling house

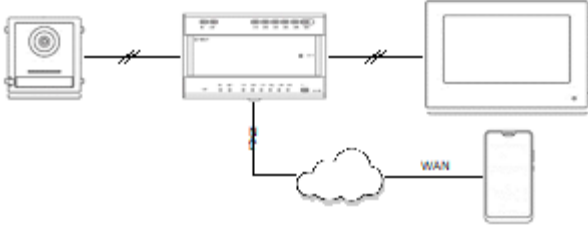
6	IP		Multi-family home with interior extension monitors
7	IP		Multi-family home with interior extension monitors and back doors
8	IP		Multi-family home with interior extension monitors, numeric keypad module and illuminated info module
9	2-wire		Single-family home
10			Single family home with side entrance

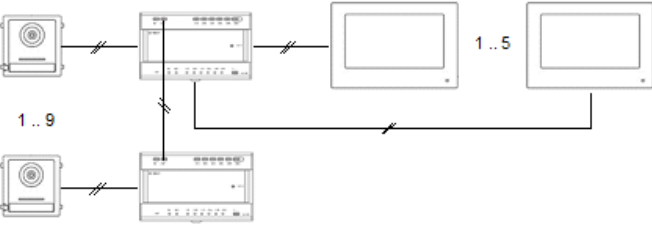
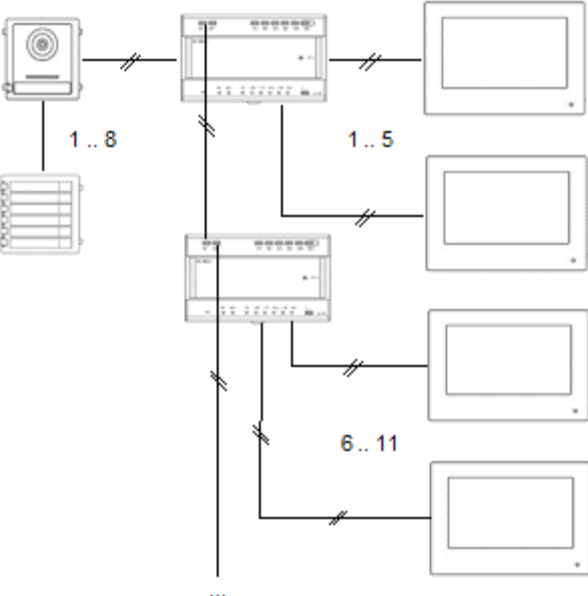
11	2-wire		Single-family home with app access
12	2-wire		Single-family home with interior extension monitors
13	2-wire		Single-family home with interior extension monitors and back doors
14	2-wire		Multiple dwelling house

15	2-wire	<p>... max. 49</p>	Multi-family home with interior extension monitors
16	2-wire	<p>... max. 43</p>	Multi-family home with interior extension monitors and back doors
17	2-wire	<p>... max. 37</p>	Multi-family home with interior extension monitors, numeric keypad module and illuminated info module

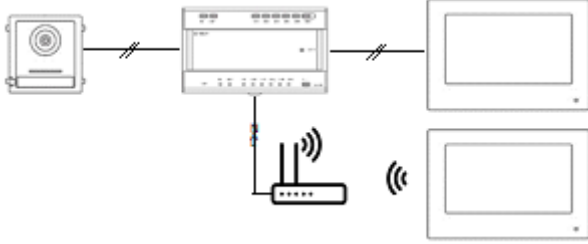
18	2-wire / IP		<p><b>Combination of 2-wire and IP technology:</b></p> <p><b>Interior extension monitor over WiFi connection</b></p>
----	-------------	--	--

<p><b>i</b></p>	<p><b>NOTE:</b></p> <p>Each monitor and each door video module will appear separately in the network and have its own IP address. It makes no difference whether the systems are connected via PoE network or to the “2-wire distributor” in the 2-wire variant. The “TVHS20200” monitor can also be integrated into the network structure via WLAN.</p>
-----------------	--

<p><b>i</b></p>	<p><b>Note:</b></p> <p>Each terminal device must be connected directly to the distribution unit. Forwarding from one monitor to the next is not permitted.</p>
-----------------	--



## **4. Start-up**

### **4.1 *Wiring***

Please see the quick-start guide that comes with the product for more detailed wiring information. The brief instructions can also be found using the product search at [www.abus-sc.de](http://www.abus-sc.de) .

.

#### **4.1.1 *Installation height***

The installation height of the video module TVHS20000(S) or TVHS20010(S) should not be less than 1.40 m (top edge). Otherwise it can happen that people standing too close to the video module cannot be recognized by their face.

## 4.2 Activation options / initial password assignment

### 4.2.1 Activation via door station monitor

- 1) Establish the system's power supply and make sure that the door station is also located in the same network.

Assign a password during initial monitor setup. This password will also automatically be used for door station activation. The password will also be required for the password-protected area of the monitor.



- 8-16 characters
- valid characters: numbers, lower-case letters, capital letters, special characters ( ! \$ % & / ( ) = ? + - )
- You must use at least two different types of character

- 2) Select the desired language and confirm by clicking "CONTINUE".

	Language assistant 1/4
English	
Deutsch	
Italiano	
Francais	
Dutch	

	<b>Firmware version note</b>
	Function: Dutch language
	Video module (THVS20000(S) / TVHS20010(S)): V2.2.3_build_201029 Monitor (TVHS20200 / 210 / 220): V2.1.2_build_201029



- 3) Now choose between DHCP / Fixer IP address. It is highly encouraged to assign each separate device a fixed IP address, as otherwise new IP addresses may be assigned in the event of a power outage and this can cause serious disruptions in the system.

	Network assistant 2/4	
DHCP		
Local IP	192.168.0.11	

Subnet mask	255.255.255.0
Gateway	192.168.0.1

	<p><b>Note</b></p> <p>When you press the switch for the DHCP function, the switch first jumps to the right and then to the left again. At this moment an IP address is obtained from the DHCP server, which is then set as a fixed IP address in the device.</p>
---	--

4) Select the type of monitor you wish to configure.

	Wizard assistant 3/4	
Indoor station Type	Indoor station	
Floor	0	
Apartment no.	1	

**Indoor station:**

The monitor acts as the main monitor for a home's door intercom system. It can be set up in a single-family or multi-family home. The main monitor in a residence must always be set up with the type "indoor station". If you only use one call button and one residence, the apartment number will remain on "1". If multiple residences/main monitors are used, the apartment numbers must be changed.

Example: Residence 1 => apartment number 1  
Residence 2 => apartment number 2  
(etc...)

This is the only way the call buttons can be assigned to different parties.

**Note:** A main monitor (indoor station) must always be linked to the main door station in the system.

**Interior extension:**

The monitor is used as an extension monitor in a system to equip more rooms in a home. All extension monitors are linked to the main monitor and display the same functions as the main monitor when the call button is pressed.



You can link up to a maximum of 5 additional monitors to a main monitors. (No. 1-5). You can also assign each monitor a "room name". The room names will automatically appear under "Contacts" on the other monitors in the system.

**Note:** An extension monitor (indoor station) must always be linked to the main monitor in the system.

The following menu items are not available on the monitor for the installation type “interior extension”. **They can only be set/accessed on the system’s main monitor:**

- Switch “automatic acceptance” for answering machine on/off.
- Listen to answering machine messages
- ABUS LINK Station App – menu
- Add network cameras
- Configure network address and set factory settings on end devices

5) “Assistant-connected devices”

Assistant-related devices			
Search by serial number			
ABUS item no.	IP address	Firmware version	Enable
			
ABUS item no.	IP address	Firmware version	Enable
			
ABUS item no.	IP address	Firmware version	Enable
			

Here you can see the available network devices in the TVHS20xxx door station series.

The main door station must be selected here if you are setting up a main monitor.  
The main monitor must be selected here if you are setting up an extension monitor.

You can also “enable” the door station here. The main monitor will then automatically activate the door station with the same password used on the monitor.

Select the main door station from the list and click “Enable” to do this. After successful activation, please select the door station. A green confirmation tick will appear on the left side of the list. The door station is now activated and successfully linked.

If no device is found in the network, make sure that the door station is located in the same network and supplied with power.

Open the IP settings for the device by clicking the corresponding “cog”. This allows you to change the IP address of the door video module.

If you would like to add other back doors, please turn to chapter “9.2 Setting up back doors” under Installation and operating information.

#### **4.2.2 Activation via IP network**

Install and start up the ABUS IP Installer (which is available for each respective product from the ABUS website [www.abus.com](http://www.abus.com)).

Each connected device should now appear in the selection list without the relevant IP address for the target network, where appropriate.

Each device must first be enabled, i.e. a correspondingly secure password must be assigned for the main user “admin”. A secure password must meet the following minimum requirements:

- 8–16 characters
- Valid characters: numbers, lower-case letters, capital letters, special characters ( ! \$ % & / ( ) = ? + - )
- You must use at least two different types of character

The IP settings for the camera can be changed using the IP installer.

The “browser” button is not available for door intercom system components as they do not have their own web server.

Most programming for the components can be done on the door intercom system’s monitor. For more complex system setup, however, you will need to use the CMS software for programming (connecting a component such as an IP device, open the menu item “remote configuration”).





	Activation in the IP network can also be done using the ABUS CMS software. The ABUS CMS software may be necessary for certain other setup steps.
---	---

#### **4.2.3 Password reset for monitor/video door module**

To reset the password for monitors or video door modules, please contact our Technical Support.

## 5. Monitor operation (2-wire & IP)

### 5.1 Live image

Button/display	Description
	Accepts the call and opens the video/voice connection.
	Ends a call and hangs up.
	Saves an instant snapshot of the current video image
	<p>Opens the doors. If multiple relay outputs are used simultaneously, there will be up to 3 key symbols. (2x door relays in door video module, 1x door relay in monitor).</p> <p>For help connecting a door opener to the relay or using the security module TVHS10040, please see <u>Installations and operating information</u> in section “9.8 Connecting electrical door openers to the video module (including “garden gate”)” and “9.1 Using the security module (TVHS10040)”</p>

## 5.2 Main page overview

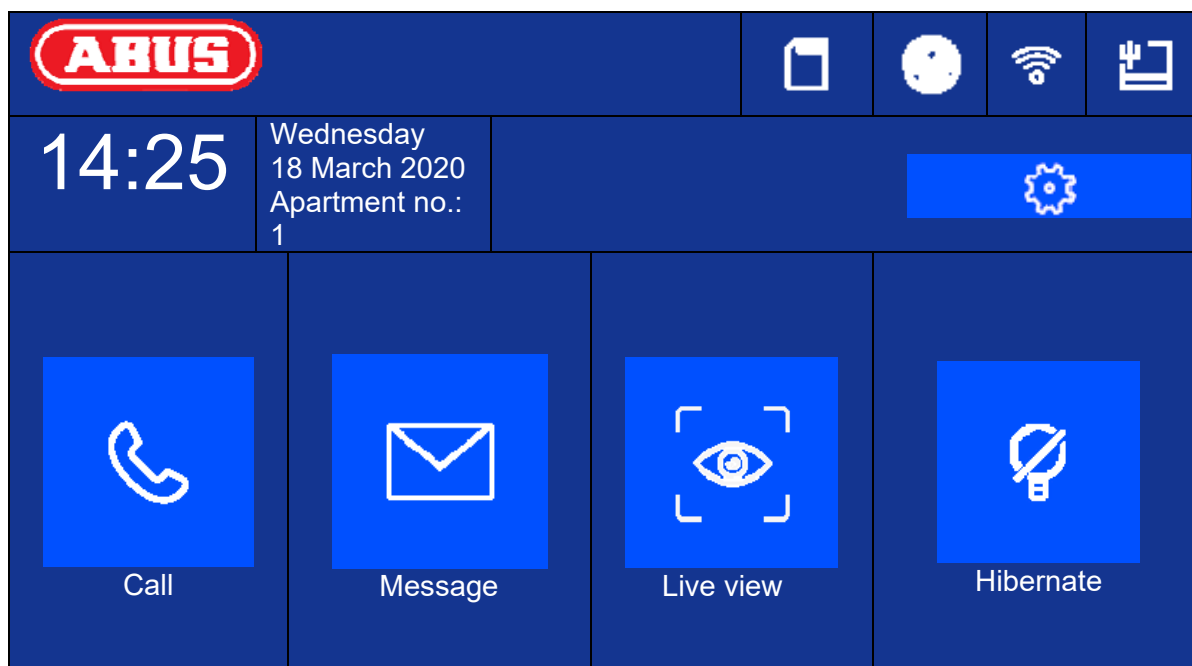

















Button/display	Description
Time	Displays time  Typing in the display field will open the dialogue to set the date and time.
Day of week/date	Current weekday display Date display
Apartment number	Display of configured apartment numbers for this indoor station. Up to 49 apartments per system possible.
[Call]	Set up intercom to indoor station or interior extension.  Display/manage contacts  View call log (including information about the door bell station, single frame, date, time)
[Message]	Information about notes, visitor notifications and single frames of the answer
[Live View]	Display live image of connected door stations and configured network cameras
[Settings/cog]	General call settings: Ring tone, ring duration, call duration, call re-routing, microphone volume, ring volume, conversation volume, key tone, auto accept, do not disturb mode  WLAN settings for the monitor (only use for IP variant!)  Other device settings: Configuration (system), relay behaviour, microSD card, time, screen brightness









### Call

Start calls between apartments or extension monitors. Contacts can also be created here. An interior extension is created automatically.

	*Enter phone number (0-0 for indoor station, 0-1 indoor station extension no. 1)				
					
					
					



















## Contacts

You can edit or delete created contacts here. To delete a contact, press and hold the contact row for 3 seconds. A menu will then appear with the option to delete contacts.





	Contacts		
Room 1			
			
			

### Call log

Displays the calls/door bells received. Can also directly access a snapshot.







	Call log			
	Main door station		14-03-2020 11:21:08	
	Main door station		14-03-2020 10:55:37	
	Main door station		14-03-2020 10:55:37	
	Main door station		14-03-2020 10:55:37	
	Main door station		14-03-2020 10:55:37	
	Main door station		14-03-2020 10:55:37	
	Main door station		14-03-2020 09:55:37	

### Note

	Note		
No note	...		 













### Visitor notification (answering machine)

Audio messages left on the answering machine can be played here, if there are any and it is enabled.























<		Visitor notification		  
No.1			14-03-2020 10:47:35	
No.2			13-03-2020 14:47:39	
No.3			13-03-2020 14:26:06	

### Recording log

Here you can find an overview of images sorted by day

<		Recording log			  
14-03					
					
					
					

### 5.2.1 Menu item: Call settings

	Call settings			
Door bell tone	Door bell tone 6			
Enable door bell tone	<input type="checkbox"/>			
Door bell duration		30 seconds		
Call duration		30 seconds		
Call re-routing		0 s		
Microphone volume		10%		
Door bell volume (monitor)		70%		
Conversation volume		10%		
Key tone	<input type="checkbox"/>			
Auto answer	<input type="checkbox"/>			
Auto Answer Immediately	<input type="checkbox"/>			
Do not disturb mode	Indoor station			
Do not disturb	All day			

Button/display	Description
Door bell tone (1~6):	Choose between 6 default door bell tones.
Enable door bell tone:	You can enable or mute the door bell tone here.
Door bell tone (1~60s):	Sets the door bell tone for an incoming call. After the set time, the door bell tone will automatically be muted. The call will still be active.
Call duration (1~60s):	Sets the call duration. After the set time, the incoming call will automatically be ended.
Call re-routing (0~20s):	Call re-routing delays the call to the ABUS Link Station app. Example: 10 seconds. After a door bell call,

	the door station monitor rings immediately, but the ABUS Link Station is called with a delay of 10 seconds.
Microphone volume (0~100%):	Set the monitor's microphone volume here. The higher the percent, the louder (and more sensitive) the monitor's microphone will be.
Door bell volume (monitor) (0~100%):	Set the monitor's door bell volume here.
Conversation volume (10~100%):	Set the desired conversation volume on the monitor here.
Key tone:	Enables the key tone when typing on the monitor's touchscreen.
Auto anser	If the function is activated, the door intercom system accepts the call with the answering machine after the bell call has expired (ring duration).
Auto Answer Immediately	When the function is enabled, the door intercom immediately accepts a call with the answering machine.  If the function is disabled, the answering machine will accept the call automatically after the set call duration.
Do not disturb mode:	Indoor station: Allows calls from door stations and extension monitors. Calls from other apartments will not be allowed. To allow calls from apartments, please set the "do not disturb" function to "disabled".  All: All calls will be rejected. (Calls from door station, extension monitor or other apartment)
Do not disturb:	Disabled, all day, time schedule (daily from/to hour/minute). Determines the time of day during which the "Do not disturb" function is active.

	<p><b>Firmware release note</b></p> <p>Function: Auto Answer, Instant Auto Answer  Video module (THVS20000(S) / TVHS20010(S)): V2.2.3_build_201029  Monitor (TVHS20200 / 210 / 220): V2.1.2_build_201029</p>
---	--

If you want to reuse an (already existing) door bell, turn to chapter “

9.5 Connecting an existing doorbell” in the section Installation and operating information.







For information on changing the volume of the video door module, turn to chapter “

#### 9.4 Adjusting the volume on the door video module (TVHS20000(S), TVHS20010(S))".

To record your own ring tones in the monitor, turn to chapter „9.9 Plays your own ring tones in the door station monitor“.





### 5.2.2 Wi-Fi settings

	Wi-Fi settings	
		
MAX_MUSTERWLAN		
		

Button/display	Description
Arming/disarming	Enable/disable the Wi-Fi interface on the monitor
WiFi network list	You can find available Wi-Fi networks in your area here. By selecting an entry, you will be prompted to enter the Wi-Fi password. After connecting successfully, a green confirmation tick will appear in the list in front of the selected network.
Wi-Fi Info Icon	You can see the Wi-Fi parameters such as network name, signal level and IP parameters here.  Click "Disconnect" to disconnect the monitor from Wi-Fi.

### 5.2.3 Floor buttons

	Floor bell	
	On/Off	











The floor button is connected directly to the monitor via the wired inputs and creates a direct door bell on the front door. This function is primarily used in multi-family homes. The main-door station is at the bottom of the main entrance here. Each home has a direct door bell button on the front door, however. The ring tone for the floor button is different from the normal ring tone of the video door module.

Button/display	Description
Line 1 – Line 8	Describes which input on the monitor is used for the floor button. Input 1 (line 1) is used as standard.
NO / NC	Normally Open / Normally Closed. This determines whether the call button on the front door is an open or closed contact. Typically it is a “NO” contact switch.

Further information can be found in the [Installation and operating information](#) section in chapter “9.7 Connecting floor call buttons to the main monitor”.

## 5.2.4 Other settings

### 5.2.4.1 Configuration – local information

	Local information			
Apartment no.		1		
Live image duration		30 seconds		
ABUS Link Station service settings				
Synchronise time				
Summer Time				
Assistant				

This area is password-protected. Please enter the password for initial setup.

**Note:** The following menu items are not available on the monitor for the installation type “interior extension”. **They can only be set/accessed on the system’s main monitor:**

- Switch “automatic acceptance” for answering machine on/off.
- Listen to answering machine messages
- ABUS LINK Station App – menu
- Add network cameras
- Configure network address and set factory settings on end devices

Installation type:

Options: indoor station, interior extension

**Indoor station:** Main monitor for door intercom system in a home/apartment

**Interior extension:** up to 5 more monitors can be connected within a home/apartment

Example: Video module + indoor station + 5 interior extensions

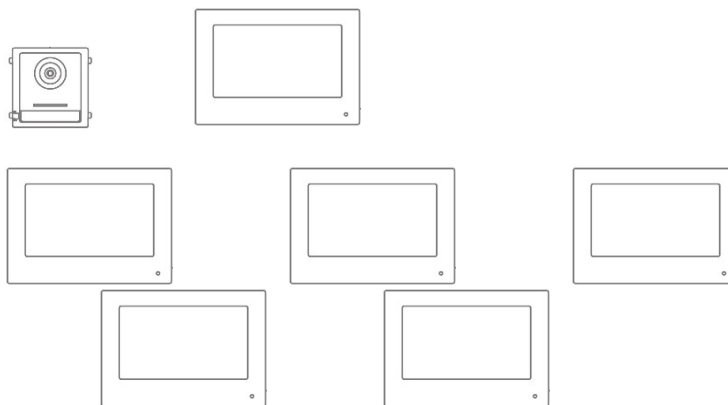

Apartment no.: This is the maximum number of indoor station monitors that can be connected to a door video module with 8 call button extensions. This maximum number is 49 indoor station monitors or 49 homes/apartments.



Only for setting “Interior extension”:

No. (1~5): Number configuration for interior extension. A maximum of 5 extension monitors are possible.

Room name: Name for the room where the extension monitor is located.

Live image duration (10~60s): Duration of the manually triggered live image display for a door video module or connected IP camera.  
(can be accessed via the main page/live image)

Information about setting up other call buttons in a multi-family home can be found in section Installations and operating information in chapter “9.3 Setting up extended call buttons (TVHS20020) for multi-family homes”.

### **ABUS Link Station service settings:**

The ABUS Link Station function helps make it easier to set up and connect a smartphone app to the door intercom system. It only takes a few steps. The door station must have an active internet connection in order to do this.



This menu only exists on monitors with the setting “Indoor station” (main monitor).

Enable this function if you would like to use the app to access the door intercom.







#### **Procedure:**

1. Install the ABUS Link Station APP (lite/pro) (Android/iOS)
2. Click “Add device” or “Scan QR Code” in the app.
- 3 Scan the QR code in the settings page for the ABUS Link Station service. Each indoor station monitor has its own QR code.
4. You will need to enter the verification code during the setup process. It is also on the setup page and can be changed as you like.

A QR code can only be added to an ABUS Link Station account. Other accounts can be granted access to the door intercom if approved.











ABUS Link Station service settings	
Activating ABUS Link Station service	
Verification code	xxxxx
ABUS Link Station server status	Connected
	

**Synchronise time:** Enable time setting via the NTP protocol.  
 The interval determines the update frequency in minutes.  
 The field IP address allows an NTP server address or IP address to be entered.  
 The port number is fixed as 123 (standard port for NTP protocol).  
 Select the time zone in which the door intercom is located (generally GMT+01:00)

Synchronise Time		
 Enable NTP		
Synchronise interval	60	
IP address / Domain	ntp.org	
Port no.	123	
Time Zone	(GMT+1:00 Amsterdam, Berlin, Rome, Paris) 	
		

	<p>When using the ABUS Link Station service in connection with the push function for a bell call, the NTP function must be activated and correctly configured.</p> <p>Make sure to use the correct NTP server address "0.pool.ntp.org".</p>
---	---

Summer time:                                  Input details for changing between summer and standard time.





	Summer Time			
	Enable DST	<input type="checkbox"/>		
Start time	Last week of March, Sunday 2:00			
End time	Last week of October, Sunday 3:00			
Shift	60min			
				

Assistant:    Restart the installation assistant. The following steps are performed with the assistant:

- a) Language setting
- b) Network setting (wired interface)
- c) Monitor installation type or mode (indoor station or interior extension) and apartment number
- d) Device connection to monitor.
  - If indoor station->     assign a video module
  - If extension -> assign the main monitor  
                                  (indoor station)







### 5.2.4.2 Configuration – network settings

This menu primarily concerns the settings for the wired network interface

Network settings		
 DHCP	<input type="checkbox"/>	
Local IP	192.168.0.11	
Subnet Mask	255.255.255.0	
Gateway	192.168.0.1	
DNS address	192.168.0.1	
DNS address 2	194.25.2.129	

Button/display	Description
DHCP	Switch DHCP on/off. It is highly recommended to set all door intercom system components to a fixed IP.
Local IP	Set the device's local IP here
Subnet Mask	Set the device's subnet mask here
Gateway	Set the device's Gateway here. The router IP is generally used here.
DNS address	Set the device's DNS address here. The router IP is generally used here.
DNS address 2	Set the device's alternative DNS address here. The router IP is generally used here.

### 5.2.4.3 Configuration – device management

	Device Management		
Main door station	192.168.0.26		
			
			

The function of this menu is different for the indoor station and interior extension. You can change the device assignments here.

**Attention:**

The main monitor in a system must always be connected to the main video module.  
 An extension monitor in a system must always be linked to the main monitor in the system.

Indoor station:           - Assigning the main door station  
                               - Add other IP network cameras for a live view. To do this, click the “+” symbol at the top right and select “Private protocol” for an ABUS network camera.



Indoor extension:       - Assigning the indoor station (main monitor)

The following interactions can also be carried out from this menu:

- Set network parameters (DHCP, IP address etc.) for door stations
- Reset door stations to factory settings

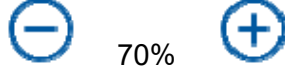

Setting the network parameters of the video door module

Door Station Settings	
192.168.0.26	
255.255.255.0	
192.168.0.1	
DHCP	
Microphone volume	
Ring tone volume	
Talk volume	
Cancel	OK

**Lines 1 -3:** IP address, gateway and subnet mask  
**DHCP:** When the button is pressed, the request for the IP address data from the DHCP server is started. The switch then goes back to the left. The received IP address data are then set as fixed data. There is no further automatic query of the data.

**Microphone volume:** Setting the sensitivity of the microphone in the video door module  
**Ring tone volume:** Setting the volume of the ring tone after pressing the bell button on the video door module  
**Call volume:** Setting the volume during a call on the video door module

Performing a reset to the factory settings of the video door module

All settings of the video door module can be reset here via the main monitor.

Reset all settings to default?	
Cancel	OK

## Adding an ABUS Network camera

To add an ABUS network camera to the system, please click the “+” symbol at the top right under “Add device”.

Select “Private protocol” for ABUS cameras and assign a device name of your choosing. The IP address of the camera in the network and the RTSP port (default 554) are also required for connection. Then you still need to enter the username and password for your network camera.









The list of compatible ABUS network cameras can be found at [www.abus.com](http://www.abus.com).

### 5.2.4.4 Configuration – default settings

**Default settings:** Resets the monitor to default settings. It will still be activated and the password will remain the same.

**Factory settings:** Completely resets the monitor including password to factory settings. The monitor will then be in “inactive” status.

### 5.2.5 Relay configuration

Relay configuration				
				
	Relay 1			
Duration			3s	
Interval			5s	
	Relay 2			

Under “Relay configuration”, the two monitor relays themselves are configured. The configuration in this menu has no impact on the video door module relay.

The relay outputs are on the back of the monitor and can be connected via the enclosed splitter cable. The assignment is printed on the back of the monitor.

The **relay 1** is switched between COM1 and NO1, **relay 2** is connected to COM2 and NO2.

Button/display	Description
Relay 1	Activates/deactivates the function for an additional (or already existing) doorbell. The relay 1 on the monitor is triggered in parallel to a call.
Duration	Determines how long the relay for the additional doorbell is triggered when pressed.
Interval	Determines the interval in which the relay is triggered for the set “duration” of the additional doorbell when pressed.

Relay 2	Activates/deactivates the additional switching output on the monitor (e.g.: for a door opener on the front door of the respective floor). If the function is enabled, another "key symbol" labelled "3" will appear on the local monitor.
---------	---

For more information, read chapter "9.6 Connecting existing door openers to the door station monitor" and

9.5 Connecting an existing doorbell” in the section Installation and operating information.

You can also find information about the following topic here: “9.8 Connecting electrical door openers to the video module (including “garden gate”)”

### 5.2.6 *microSD card*

Button/display	Description
Format	<b>Important:</b> The complete micro SD card is formatted and all data on it will be erased.
uninstall, deinstall, uninstallation, deinstallation, uninstalling, deinstalling	Deactivates the microSD card, after which it will no longer continue to record. You can safely remove the microSD card.

### 5.2.7 *Lock screen*

Locks the screen for 30 seconds. During this time, the touch panel will be disabled and can be cleaned, for example.

### 5.2.8 *Device information*

Here you can find the firmware version of the monitor as well as the model and serial number of your device. For update information, please turn to chapter “ABUS CMS software: Firmware Update” in section Installation and operating information.

### 5.2.9 *Time setting*

Here you can manually set the date and time on the monitor. Alternatively, you can also click directly on the time on the main screen.

### 5.2.10 *Restart device*

Restarts the monitor.

### 5.2.11 Password settings (PIN CODE)

#### PIN assignment for keypad TVHS20030

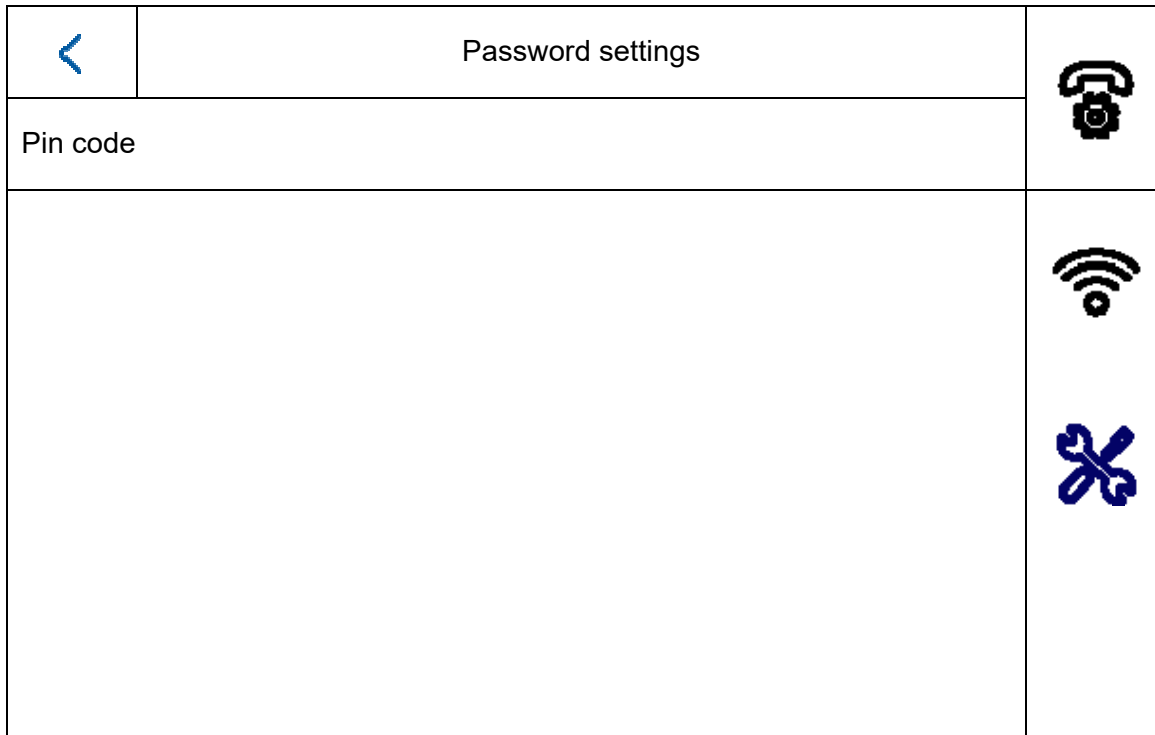

Note: You will need the keypad for PIN CODE entry TVHS20030 for this.

You can set a 6-digit key here that will then be used to open the doors via keypad. The PIN code is always 6 digits.

Please press the following combination to enter the PIN on the keypad:

Up to firmware V2.0.8 / V2.1.2 build 200410:

"#" 6-digit PIN "#". Example: # 123456 #

From firmware V2.2.3 / V2.1.2 build 201029:

"#" Apartment number 6-digit PIN "#". Example: # 1123456 #

- i.e. from this firmware the PIN can be set individually for each apartment.
- It is now possible to change and delete apartment-dependent PINs

Locally on the monitor, **one** PIN CODE can be assigned. **Three** more codes can be entered using remote configuration with the ABUS CMS software. This means that a total of up to 4 PIN codes are possible. To add a code via ABUS CMS software, open remote configuration for the door video module and select the menu item "Intercom" and "Permission password". The PIN codes are generally saved in the video module and not in the keypad.

## 5.2.12 System language

Select your desired language.

### Remote Configuration

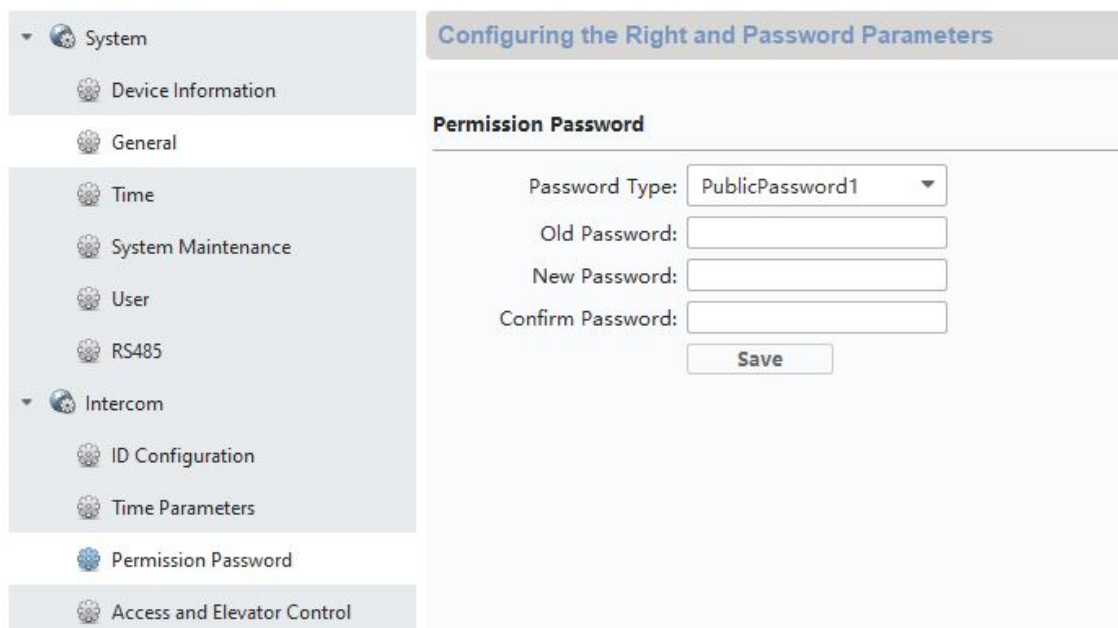

The screenshot displays the 'Remote Configuration' interface. On the left is a navigation menu with categories: System (Device Information, General), Time, System Maintenance, User, RS485, Intercom (ID Configuration, Time Parameters), Permission Password (highlighted), and Access and Elevator Control. The main content area is titled 'Configuring the Right and Password Parameters' and contains the 'Permission Password' section. This section includes a 'Password Type' dropdown menu set to 'PublicPassword1', three input fields for 'Old Password', 'New Password', and 'Confirm Password', and a 'Save' button.

## 5.2.13 Brightness setting

Here you can adjust the monitor's brightness from 0 – 100%.

## 5.2.14 Floor button

Activates/deactivates the floor button function. If the function is enabled, another menu item will appear on the right under the "Wi-Fi" symbol. The floor button function is now available and can be used via the monitor's wired inputs. Further clarification can be found under "9.7

Connecting floor call buttons to the main monitor" and "" in the section Installation and operating information.

## 5.2.15 Open Source Licence information

Please read the Open Source Licence information at the end of this document.

## 6. Maintenance and cleaning

### 6.1 *Function test*

Regularly check the technical safety of the product, e.g. check the housing for damage.

If it appears to no longer be possible to operate the product safely, stop using it and secure it to prevent unintentional use.

It is likely that safe operation is no longer possible in the event that:

- the device shows signs of visible damage
- the device no longer works correctly
- the device has been stored in adverse conditions for a long period of time
- the device has been exposed to stresses during transportation.



**Please note:**

You do not need to perform any maintenance on the product. There are no components requiring servicing or checking inside the product. Never open it.

### 6.2 *Cleaning*

Clean the product with a clean, dry cloth. The cloth can be dampened with lukewarm water to remove stubborn dirt.



Make sure that no liquids get into the apparatus and thereby destroy the device. Do not use any chemical cleaning products, as they could damage the surface of the housing.

## 7. Disposal



Devices displaying this symbol may not be disposed of with domestic waste. At the end of its lifespan, dispose of the product according to the applicable legal requirements.

Please contact your dealer or dispose of the products at the local collection point for electronic waste.

## 8. Open Source Licence information

The product contains software components that are licensed by the rights holders as free software or open source software (hereinafter referred to as "OSS"). The corresponding licenses are enclosed with the product in printed form and / or can be accessed via a graphical user interface. You can acquire usage rights to the extent regulated there directly from the rights holders. The open source licenses take precedence over all other license conditions and contractual agreements with ABUS in relation to the corresponding OSS software components contained in the product.

In general, license information on ABUS products can be called up at [www.abus.com](http://www.abus.com) in the download area of the product description.

## 9. Installation and operating information

### 9.1 Using the security module (TVHS10040)

The security module TVHS10040 (new item number TVHS20340) serves to fit the door opener contact indoors under protection and thus prevent tampering. The security module is supplied with 12V voltage and clamped to the door video module by means of RS485-BUS.

Please use the enclosed 4-pin cable for the door video module. This cable must be isolated on one side of the connector and the cable must be connected to the security module. The ID DIP switches on the security module are not needed for this and will remain set to their default value. (DIP switch 1 on, DIP Schalter 2/3/4 off)

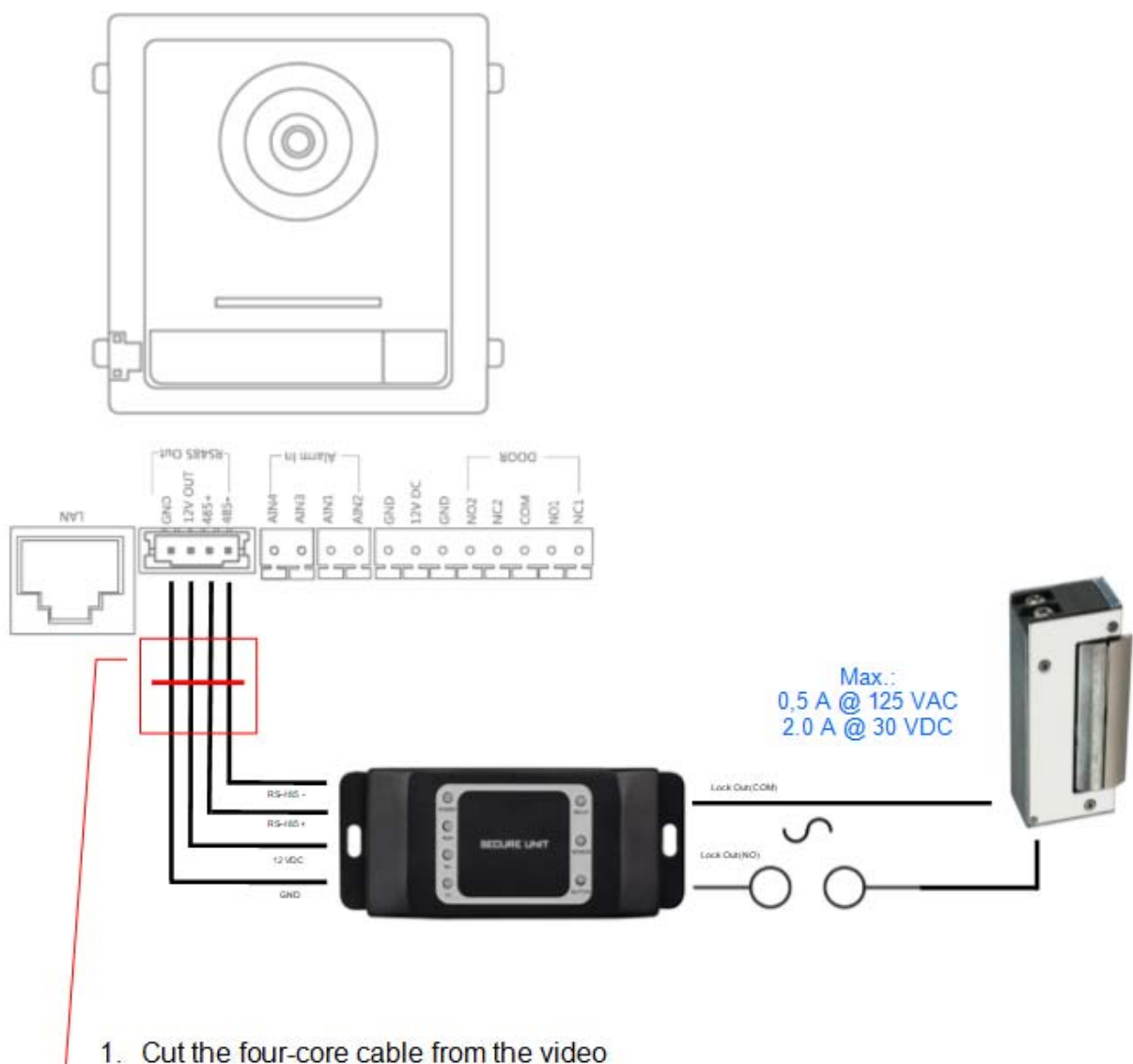

2. Connect the 4 wires with the following color to the safety module.



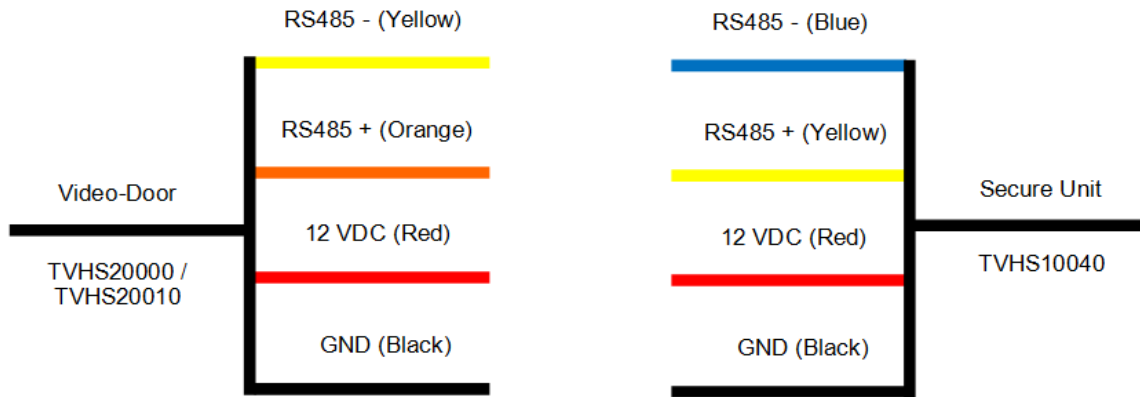

Up to firmware V2.0.8 / V2.1.2 build 200410:

The security module still has to be configured as a new door relay. To do this, open the remote configuration of the door video module with the ABUS CMS software and go to the "Intercom" / "IO In Out" menu and set "IO Out" for "DOOR 1" to "securityModule"

From firmware V2.2.3 / V2.1.2 build 201029:

After connecting the safety module, it is automatically recognized.

Now the relay security module will be triggered instead of the internal relay for the door video intercom module when the door is opened. While the relay is active, the green LED "Relay" will light up on TVHS10040.

**Attention:** Only one security module TVHS10040 / TVHS20340 may be used per video door module!

**Note:** The security module is always the last module connected, whether there is only a video door module or additional extension modules are connected.

Maximum relay load: max. 2A 30VDC / 0.5A 125AC

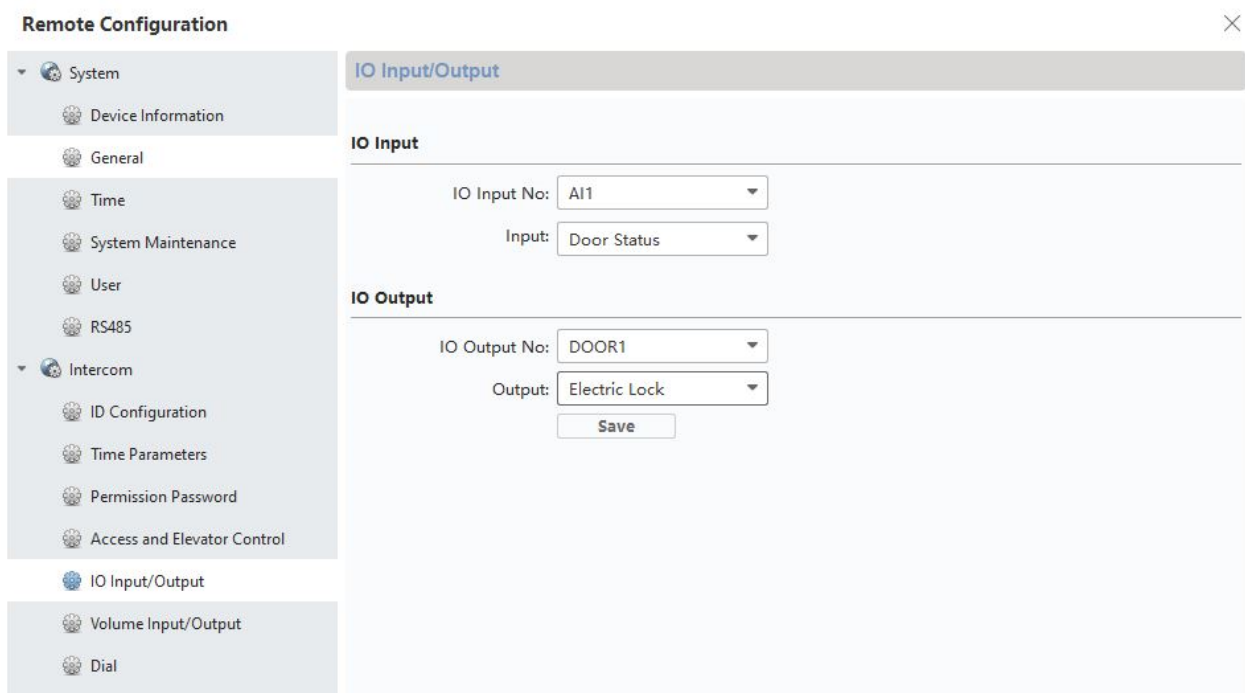

## 9.2 Setting up back doors

If you would like to integrate another door video module (maximum of 16) into the system to add a back door (e.g.: receiving goods, cellar doors etc.), follow these steps:

- 1) Connect the door video module for the back door to the network for the main door intercom station. All devices at the door intercom station must be located on the physical LAN.
- 2) Open the ABUS CMS software and activate the door module for the back door.
- 3) Add the door intercom module for the back door in ABUS CMS software and open remote configuration.
- 4) Now turn to “Room Number” under “Intercom”. The numbers for the back door are entered under “No.:”. The main door video module must have the number “0”. The additional back doors will be numbered 1-9. Do not change the “Period/Building/Unit or Floor” numbers.

After savings, the system will restart. Confirm by pressing “OK”.

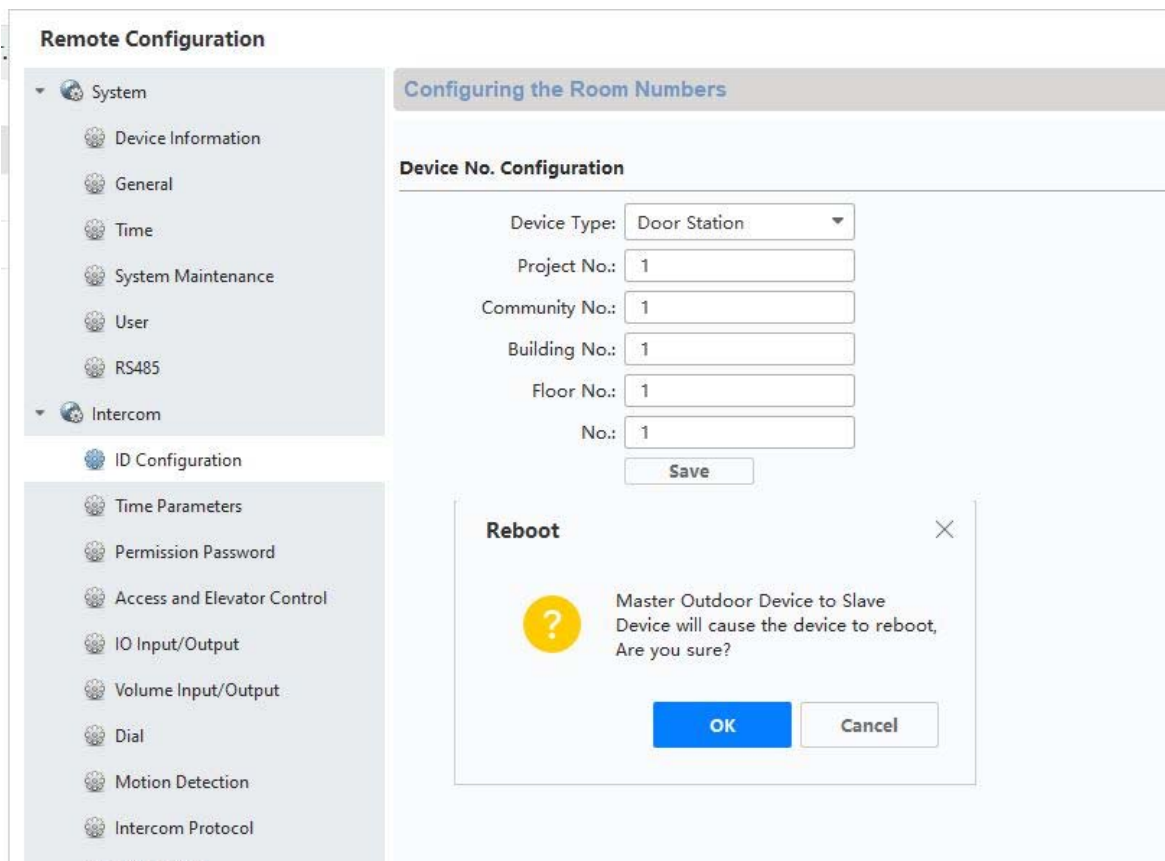

- 5) After successful restart, you will still need to assign the main doors for the back door. To do this, enter and save the IP address of the main door station under “Network” / “NetConfig SIP” under “(Main) Outdoor IP Address”.

**Attention:** The menu “(Main) Outdoor IP Address” will only appear if you have properly completed step 4).

The screenshot displays the 'Remote Configuration' web interface. On the left is a navigation menu with categories like Time, System Maintenance, User, RS485, Intercom, and Network. The 'Network' category is expanded, showing 'Local Network Configuration' and 'Linked Network Configuration'. The main content area is titled 'Configuring the Network and Sip Parameters' and contains the 'Linked Network Configuration' form. This form includes a 'Device Type' dropdown set to 'Door Station', and input fields for 'Master Station IP Address' (0.0.0.0), '(Main) Door Station IP Address' (192.168.0.45), 'SIP Server IP Address' (0.0.0.0), 'Security Control Panel IP Address' (0.0.0.0), and 'Security Control Panel Port No.' (0). A 'Save' button is located at the bottom right of the form.

- 6) Setup for a back door is now complete. Now if a call button is pressed at the back door, the monitor will show that the call was started at a back door. Under “LIVE IMAGE” you can now directly access the video image of the back door on the monitor and open the doors.

### 9.3 Setting up extended call buttons (TVHS20020) for multi-family homes

Up to 49 call buttons can be used for multi-family homes via the additional module (TVHS20020(S)). The extension module is connected directly to the main video module via connecting cables.

If only one additional call button module is used, the installation can be done without the ABUS CMS software.

The main door module is by default the bell with “Apartment number 1”. The extension module TVHS20020 is automatically set to apartment number 2–7. The “apartment” here corresponds to a separate residence.

If you do not use the call button for the main video module and seal it with a cover plate, you will need to configure the extension module TVHS20020(S) via the ABUS CMS software. All extension modules connected to the RS-485 can be found under “Intercom” / “Submodules”. (Exception: the security module TVHS10040/TVHS20340 does not appear here)

In the menu “*Submode*”, click the “Settings” symbol to assign the apartment numbers.

The submodule ID is based on the ID set via DIP switch on the back of the extension module’s housing. This allows you to easily make the proper assignments when setting up multiple extension modules.

**Attention:** After changing the ID via IP switch, the respective extension module must be briefly disconnected from the cable and restarted.

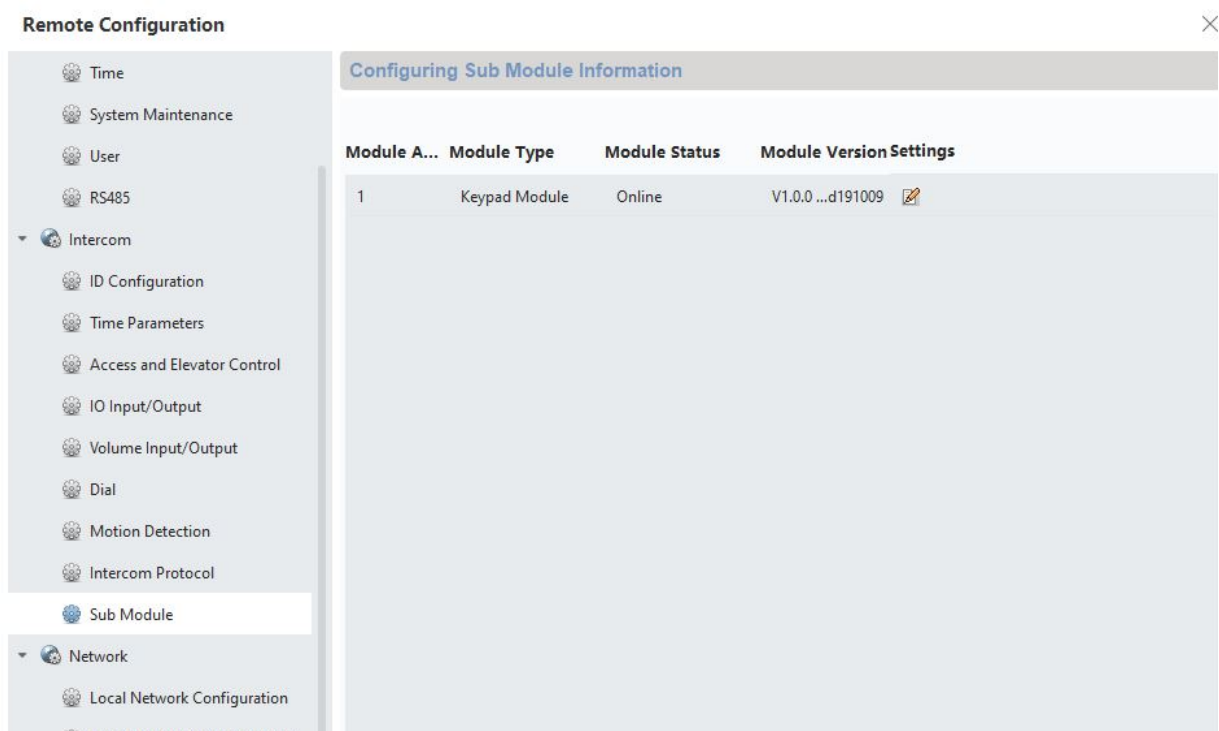

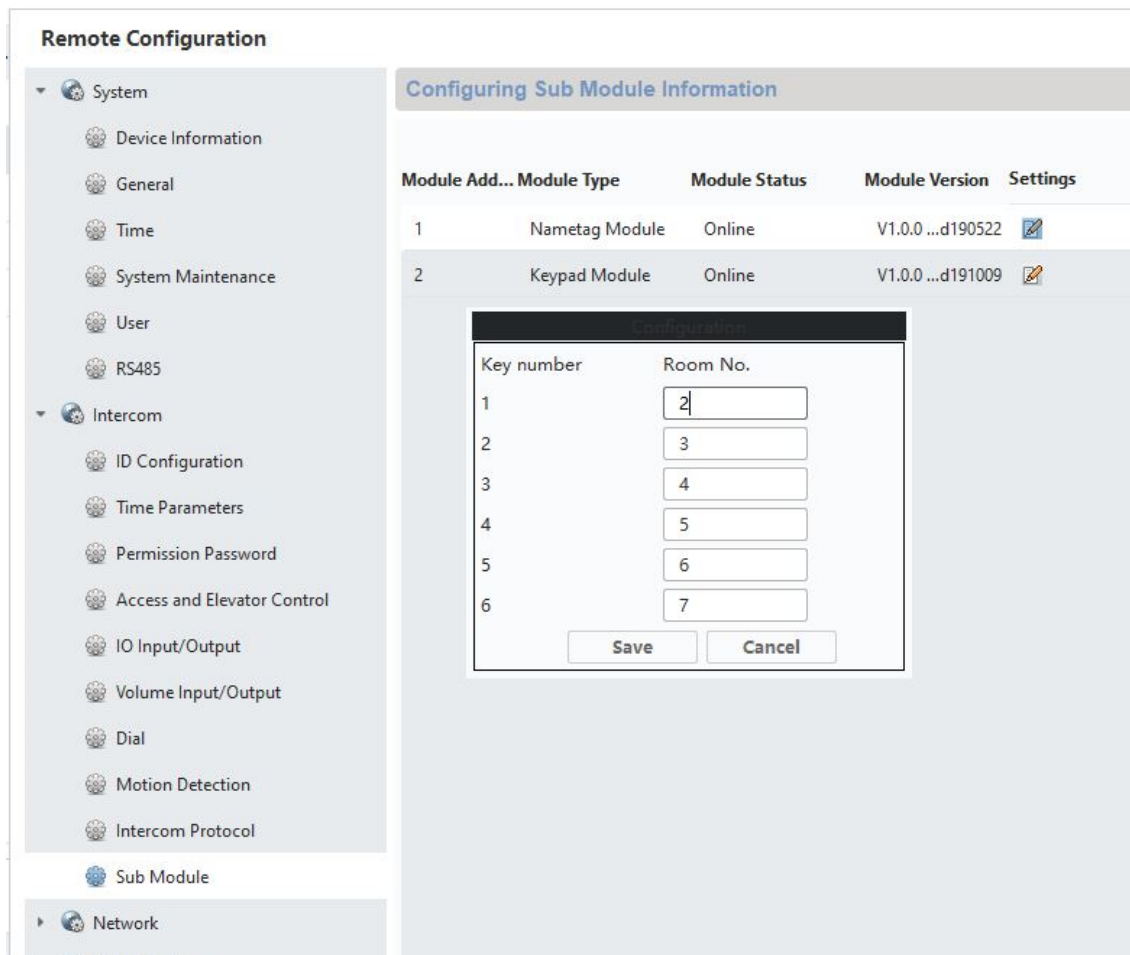

Configuring the apartment number/residence number in the monitor:

In order to assign the call buttons in the residence to the correct monitors, the apartment numbers for the monitors must match the call button numbers.

The apartment numbers for the respective monitor are displayed in the monitor's main overview. You can either change the numbers directly in Configuration on the monitor (configuration/apartment no.) or access the respective monitor using ABUS CMS software and, in the menu "*Intercom*"/*Room Number*", change the apartment/residence numbers under "*room.No.*".

Example for the cover of the bell button on the video door module

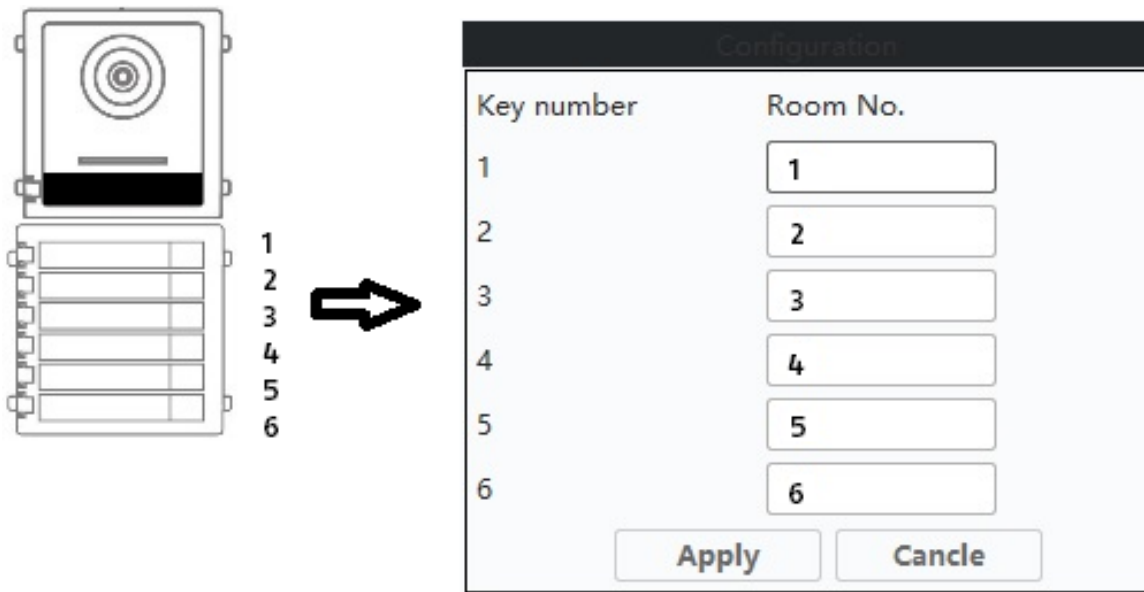

### 9.4 Adjusting the volume on the door video module (TVHS20000(S), TVHS20010(S))

Microphone sensitivity and voice volume on the door video volume can be adjusted using the ABUS CMS software. You can also set or fully disable the confirmation tones/call tones/busy signal volume.

Button/display	Description
Volume In	Controls the microphone sensitivity for the door video module. The higher the value, the louder we will transmit voice to the monitor.
Volume Out	Controls automatic voice output (e.g.: leave a message, call failed etc. This controller can also be used to adjust the volume of confirmation tones/call tones and busy signals. (0 is completely mute)
Talk Volume	Voice volume is adjusted here. The higher the value, the louder the voice will be transmitted from the monitor to the door station.

**Remote Configuration**

- System
  - Device Information
  - General
  - Time
  - System Maintenance
  - User
  - RS485
- Intercom
  - ID Configuration
  - Time Parameters
  - Permission Password
  - Access and Elevator Control
  - IO Input/Output
  - Volume Input/Output**
  - Dial
  - Motion Detection
  - Intercom Protocol

Configuring the Volume Input or Output

---

**Volume Input**

Volume: 

 7

---

**Volume Output**

Volume: 

 7

---

**Talk Volume**

Talk Volume: 

 7

### 9.5 Connecting an existing doorbell

If you already have a doorbell, it can be connected to the relay output 1 (COM / NO I) on the monitor. The maximum relay load is 2A @ 30VDC or 0.5A @ 125AC.

If a call button is pressed, the relay will be switched at the desired interval and for the desired duration. The configuration for "Relay 1" can be found in the monitor's menu under "Relay configuration".

The relay, as well as the local ring tone on the monitor, will be triggered as long as is set under "Ring tone duration" in the "Call settings" menu.

If you only want to hear your external doorbell ring once, you can simply enable or disable the door bell tone on the monitor in the "Call settings" in the "Enable door bell tone" menu.

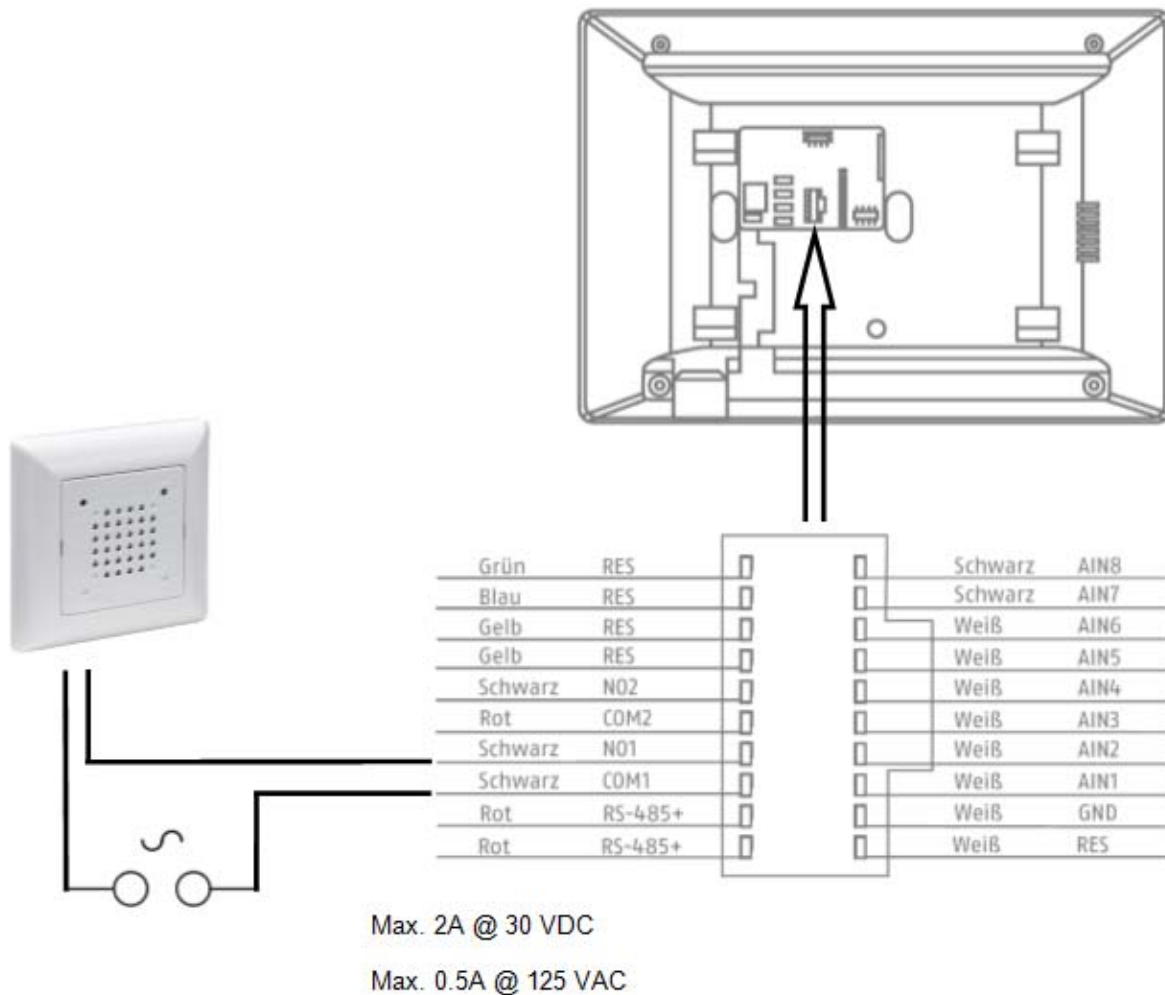

### 9.6 Connecting existing door openers to the door station monitor

To open a front door separately from a main entrance door, the monitor offers the option to control another door via a relay output (relay 2). The maximum relay load is 2A 30VDC or 0.5A 125AC.



To use the relay on the monitor, please enable “relay 2” under “relay configuration” in the monitor menu. Now another “key” symbol labelled “3” will appear in the monitor. Labels “1” and “2” are reserved for the door video module relays.

Relay “3” on the monitor can only be switched directly via the monitor, and not via the ABUS LINK STATION app.

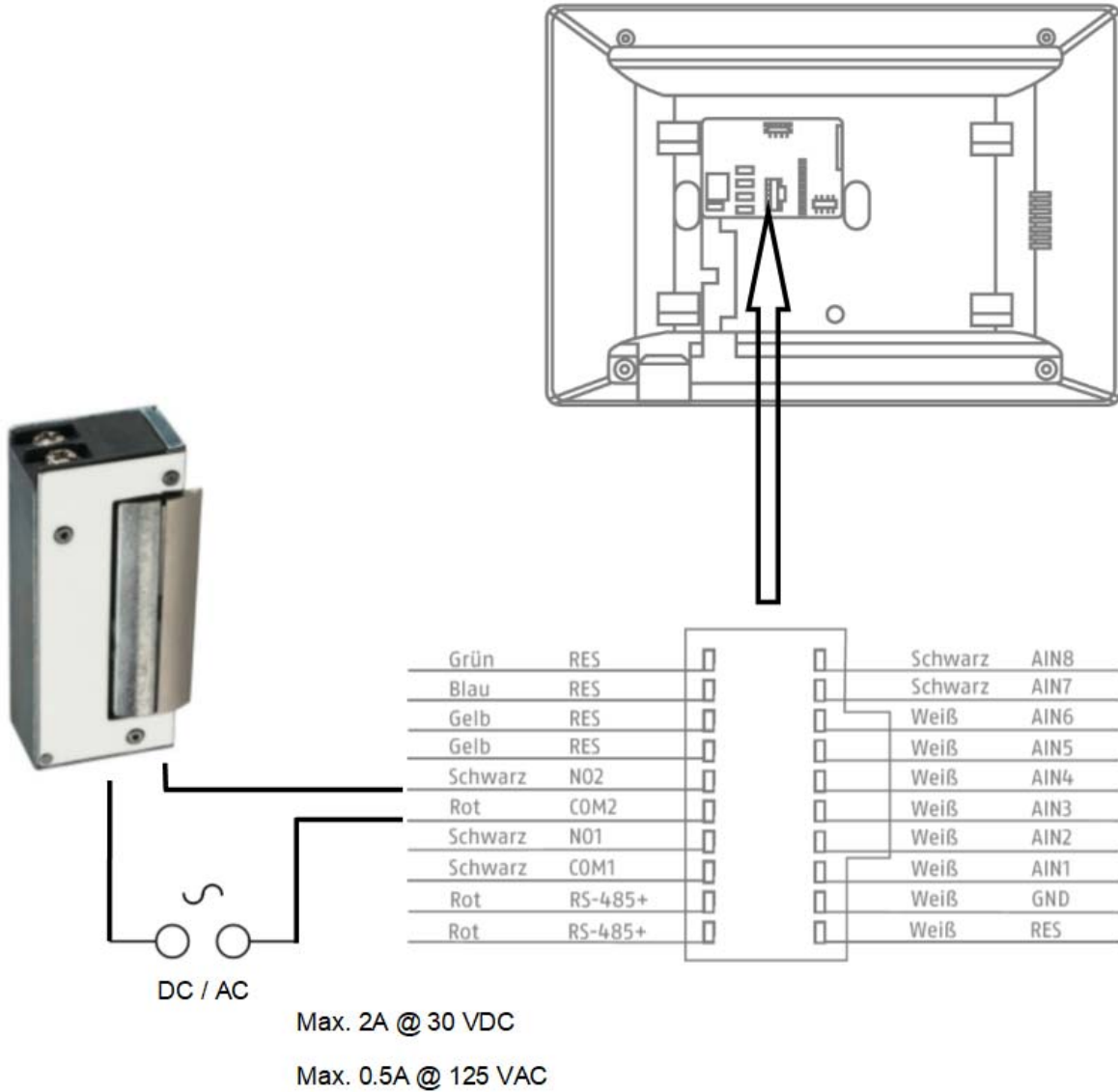

### 9.7 Connecting floor call buttons to the main monitor

The floor button (call button directly on the front door of a multi-family home) can be connected directly to the monitor. Directly wired to alarm input 1, the monitor can emit a bell signal and signal to the customer that someone has rung the upper front door.

**Note:** The floor button ring tone cannot be changed. It is different from the call button on the door video module so that it is obvious where the call originated. The floor button does not trigger an interaction on the monitor. Only a short ring tone will sound.

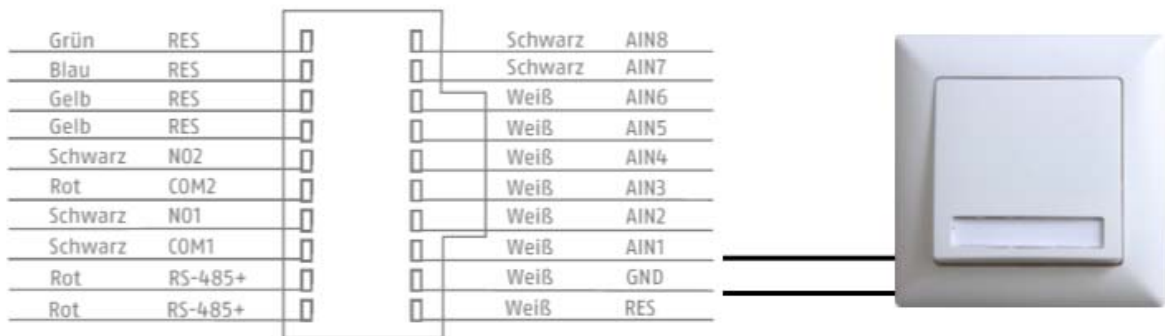
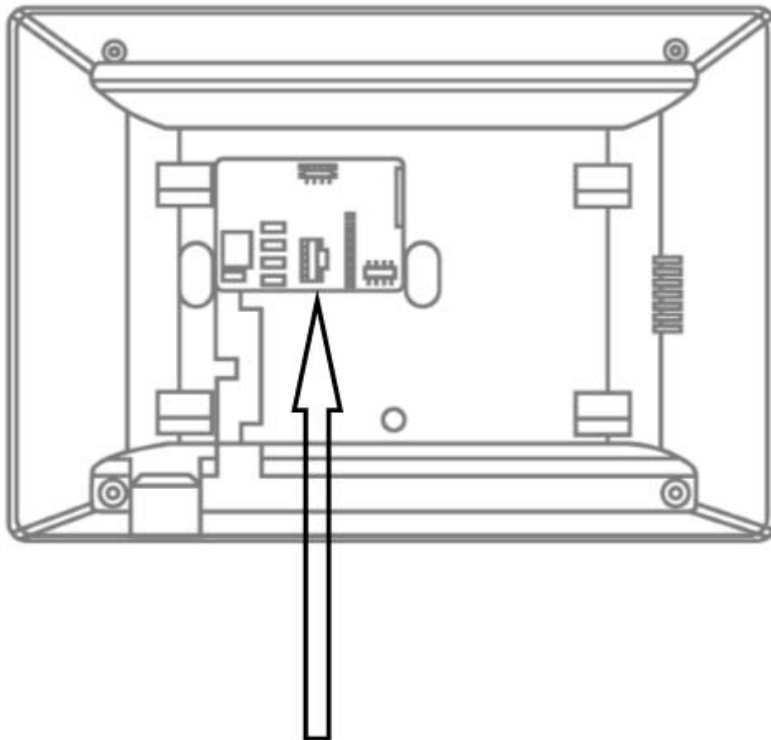

### 9.8 Connecting electrical door openers to the video module (including “garden gate”)

2 independent relays can be switched on the door video module and used to e.g.: open doors. To configure the relays, open remote configuration for the door video module with the ABUS CMS software and go to the menu “Intercom” / “IO In Out”.

The respective relays for DOOR 1 and DOOR 2 can be configured under “IO out” or disabled if necessary. If the relay is disabled, the “key” symbol to open the door will not in the ABUS Link Station app or on the monitor.

Note: Only one of the two relays may be on “securityModule” (security module TVHS10040).

Button/display	Description
Disable	The relay is not used and hidden from view
electricLock	The internal relay for the door video module is used
securityModule	The external security module TVHS10040 is used. (See menu item “security module”)

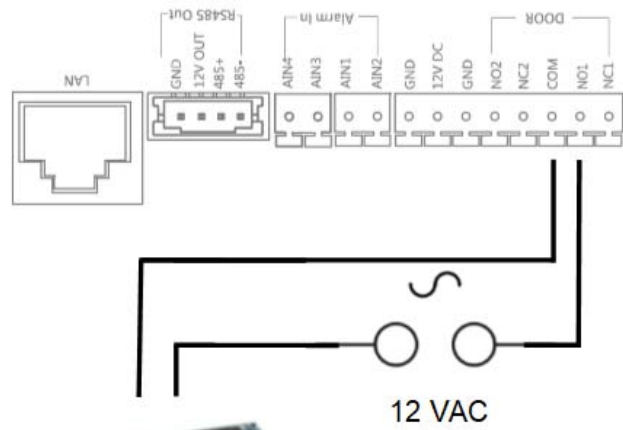
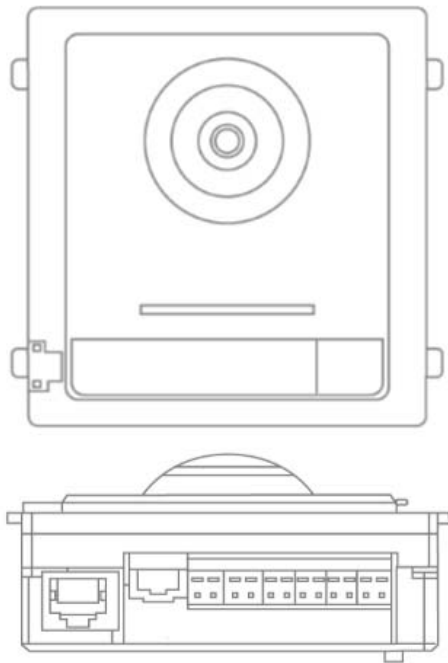

Max. 0,5 A @ 125 VA  
 Max. 2,0 A @ 30 VDC

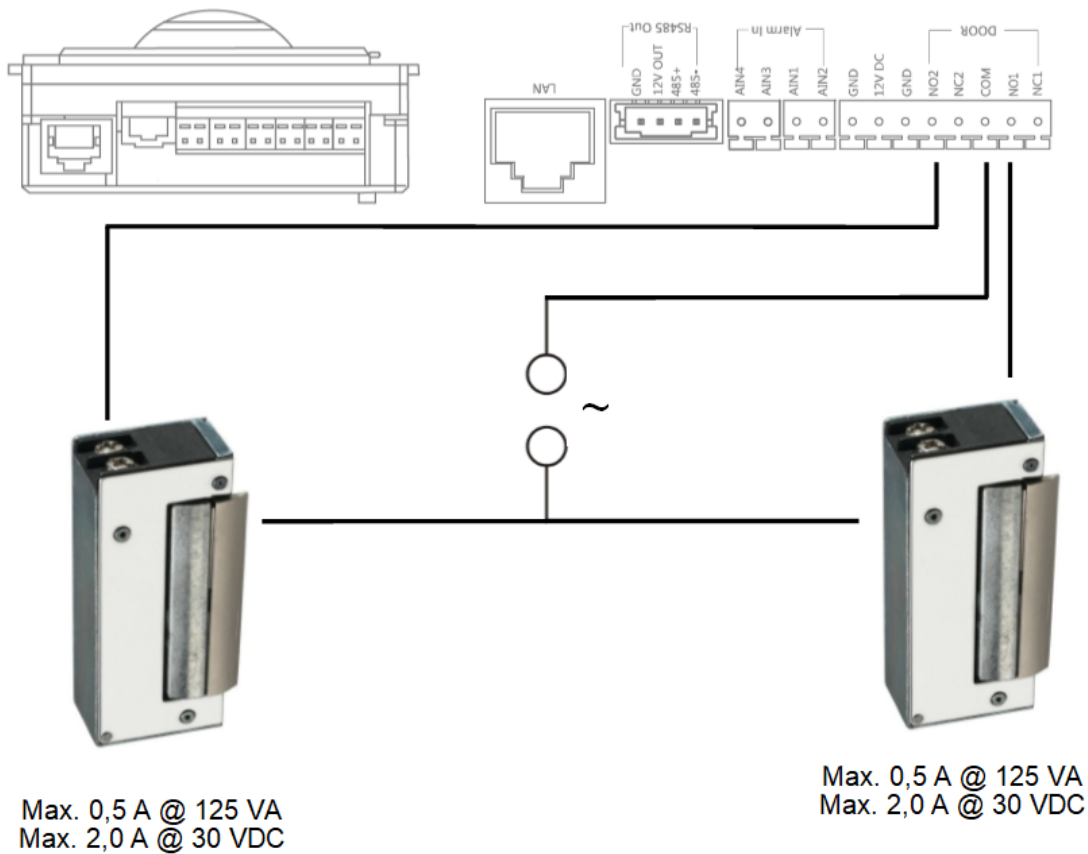

### 9.9 Plays your own ring tones in the door station monitor

You can load your own ring tones in \*wav format to your monitor using the ABUS CMS software. To do this, open remote configuration for the respective monitor and go to “Intercom” in the “Ring import” menu. Select an open slot here and upload the \*WAV audio file. Once it has successfully uploaded, the file will be available under “ring tones” directly on the monitor.

**Attention:** A ring tone selected in the monitor cannot be erased using ABUS CMS. First select another ring tone in the monitor and then try again to erase the ring tone in CMS.

The WAV file must fit the following parameters:

- Format: wav;
- Maximale size: ≥300Kb;
- Bit rate: 8KHz;
- Channel: Mono
- Bit rate: 128Kbps

## Remote Configuration



- System
  - Device Information
  - General
  - Time
  - System Maintenance
  - User
  - RS485
- Intercom
  - ID Configuration
  - Time Parameters
  - Permission Password
  - Zone Alarm
  - IP Camera Information
  - Volume Input/Output
  - Ring Import
- Deploy Info
- Incoming Call Linkage
- Relay
- Network

### Ring Configuration

Index	Name	Size	Type	Add	Delete
1	Sprach...1_sd_2	185466	wav	+	×
2				+	×
3				+	×
4				+	×

## 9.10 ABUS CMS: Perform firmware update for Moduvis components

**Attention:** Never disconnect the power supply or network cable during an upgrade

**Attention:** Only perform the update in a stable network environment (LAN).

We recommend setting each device to factory settings after a firmware update.

The ABUS CMS software is required to upload a firmware update to a monitor or the video door. Connect the devices to the network and open the remote configuration for the respective devices.

Go under “Maintenance” / “System Maintenance” and select the corresponding file for the device.

The screenshot displays the 'Remote Config' interface. On the left is a navigation menu with categories: System (Device Information, General, Time), Maintenance (User), and a list of components (Talkback, Network, Display, CCD). The main area is titled 'System Maintenance' and contains three sections: 'Management' with buttons for Reboot, Restore Factory Settings, Restore All, Import Config. File, and Export Config. File; 'Update Remotely' with a 'Choose Type' dropdown set to 'Controller Upgra...', a 'Choose File' input field with a file selection icon, an 'Upgrade' button, and a 'Process' progress bar; and 'Language' with a dropdown set to 'German' and a 'Save' button.

“Controller upgrade” must be selected when updating a door video module (TVHS20000(S), TVHS20010(S)).

The current firmware version can be determined using ABUS IP Installer or in the CMS software in the respective device configuration under “Device Information”.

**Remote Configuration** ×

System

- Device Information
- General
- Time
- System Maintenance
- User
- RS485
- Intercom
- Network
- Video Display
- CCD

**Displaying the Device Information**

**Basic Information**

Device Type:

Device Serial No.:

**Version Information**

Version: V2.2.3 build 201029

Hardware Version: 0x0



After a firmware update, the following steps must be carried out:

1. Restart the entire system by removing the supply voltage
2. Reset all updated devices to factory settings ("Restore all")

## 9.11 ABUS CMS: Advanced setting options

Below is a brief overview of the setting options via remote configuration with the ABUS CMS software.

Each monitor and each door video module will appear in the network as a separate network device, regardless of whether the device is connected via 2-wire or PoE.

Remote settings for **TVHS20000(S)**, **TVHS20010(S)**, video door module:

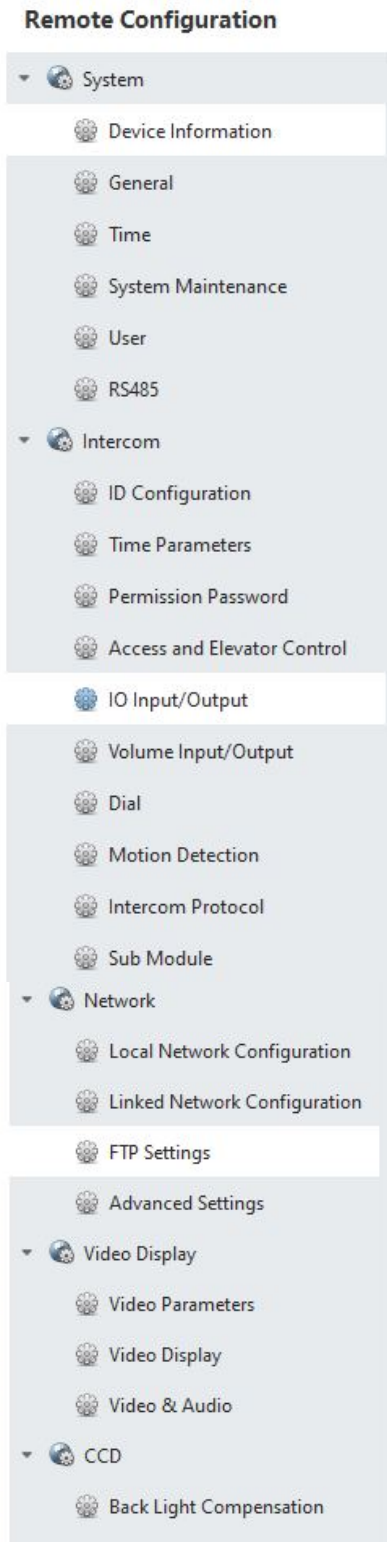

	"System" section
Device Information	General information about firmware, serial number
General	Device name and device ID (not relevant for door intercom system)
Time	Settings for date/time, summer time and NTP server
Maintenance	Maintenance menu for firmware update, set factory settings and restart device
User	Menu is not used
RS485	Menu is not used
	"Intercom" section
ID Configuration	"Device type" must always be on "Outdoor unit". Please do not change any numbers for the units "Period, Building, Unit, Floor" as these values are not needed here. Back doors are set up under "No.". 0 = main doors, "1" – "9" = back doors. Please consult the chapter "Setting up back doors". (See <a href="#">Installation and operating information</a> )
Time Parameters	<b>Max talk time:</b> Maximum conversation duration for an accepted call. (90-120s) <b>Max Msg time:</b> Recording time for answering machine (30-60s)
Permission Password	3 additional PIN codes (6-digit) can be set here to use in combination with TVHS20030.
Access and Elevator Control	<b>Door. No.:</b> Select between relay output 1 and 2. <b>Open door time:</b> Determines how long the relay should engage the door opener. (1-255s)  "Door name" and "Card encrypt" not used.
IO Input/Output	Settings for digital inputs (for emergency door opener) and the relay for door opener.



Volume Input / Output	Audio parameter settings for video door module. (See <a href="#">Installation and operating information</a> )
Dial	Determines the apartment assignment for the call button on the door video module itself. A "1" will be under "room no." as standard from the factory. This means the monitor is called with apartment number 1.
Motion Detection	Motion detection setting in connection with ABUS NVR. (Please only set up and configure the motion detection directly via ABUS NVR)
Intercom Protocol	Not used
Sub Module	Overview of connected extension modules e.g.: TVHS20020, TVHS20030, TVHS20040
	"Network" section
Local NetCfg	IP address of video door module. ( <b>IP address, subnet mask, standard gateway</b> )  <b>Port: 8000</b> is needed to connect to an ABUS NVR  <b>http Port</b> is not needed as there is no web interface
Linked Network Configuration	Menu item is not used on a main video door module.  <b>Main Outdoor IP Address:</b> Is used to assign the main door station to a back door. (See <a href="#">Installation and operating information</a> )
FTP Configuration	Not used
Advanced Settings	Configuration of DNS server address for door video module
	"Display" section
Video Parameter	Settings for image parameters (brightness, contrast, saturation)
Video Display	Settings for OSD display (camera name, date, time, text position)
Video&Audio	Stream parameter settings for video door module camera. <b>Attention:</b> We do not recommend modifying settings.
Back Light Compensation	BLC function options for compensating for back light.

Remote configuration “Monitor TVHS20200, TVHS20210”:



Device Information	Information such as “firmware”, “serial number” etc.
General	Device name and device ID (not relevant for door intercom system)
Time	Settings for date/time, summer time and NTP server
Maintenance	Maintenance menu for firmware update, set factory settings and restart device
User	Not used
RS485	Not used
	“Intercom” section
ID Configuration	Selection of apartment numbers in “Indoor station” mode (main monitor) In “Station Extension” mode (extension monitors), the number of the extension monitor is configured.  Note: The “main monitor” or “extension monitor” mode is typically selected and the numbers assigned through the menu on the respective monitors. (e.g.: In setup process via installation wizard)
Time Parameters	Settings for call duration, live image display time, call forwarding delay, ring tone duration. Note: These settings can also be changed directly in the monitor’s menu.
Permission Password	Is not used in the monitor’s remote configuration.
Zone Alarm	Not used
IP camera information	Add ABUS network cameras. (See compatibility list) Up to 16 ABUS network cameras can be added and watched live. (Camera cannot be played back or configured directly from the door station)
Volume Input/Output	(See <a href="#">Installation and operating information</a> )
Ring Import	Manage own ring tones (See <a href="#">Installation and operating information</a> )
Deploy Info	Not used
Incoming Call Linkage	Not used
Relay	Not used
	“Network” section
Local NetCfg	Monitor IP address. ( <b>IP address, subnet mask, standard gateway</b> )

	<p><b>Port: 8000</b> is not needed here</p> <p><b>http Port</b> is not needed as there is no web interface</p>
Linked Network Configuration	<p>Assign the main monitor and the main door video module. The IP address of the main door module is entered here in the case of a main monitor.</p> <p>The entry "MainOutdoorUnit" may not be changed.</p> <p><b>Note:</b> The door video module is typically already assigned to the monitor when setting up locally on the monitor itself.</p>
Advanced Settings	Configuring monitor's DNS server.
ABUS Link Station	<p>Configure access via ABUS Link Station App. <b>See ABUS settings Link Station service.</b> Connection to the ABUS Link Station app can simply be done via the interface on the monitor itself.</p>

### 9.12 MODUVIS and ABUS Link Station app range of functions

The MODUVIS door intercom can be integrated into the ABUS Link Station app. The following options are available:

- Change verification code: The verification code should first be changed in the menu item "ABUS Link Station Service". Click on the code currently displayed to do this.
- Add: Scan the QR code and add the device to the app. You still need to enter the verification code.
- Share device: The door intercom can be shared with other users. This allows multiple people or apps to access the system.
- Push options: The ABUS Link Station app will be called immediately or on a delay when someone rings the door intercom. The call can be accepted on the app and two-way audio with video of the door station is possible. Video may be disabled with voice-only if reception quality or mobile bandwidth is limited.
- Door open: relay 1 or relay 2 can be switched in the app. This allows electrical door openers, for example, to be controlled.
- Event log: The app has a notification page with entries from the most recent door bell activity with a picture of the event.

### 9.13 Compatibility with ABUS products

This section addresses possible interaction with other ABUS products.

ABUS product	Compatibility
Secvest	No
WAppLoxx	Relay connection
WAppLoxx Pro	Relay connection
ABUS IP cameras	See compatibility list <a href="http://www.abus.com">www.abus.com</a> , <a href="http://www.abus-sc.de">www.abus-sc.de</a>
ABUS NVR	For integrating the door station video, see section 9.14
ABUS Link Station APP	Access live image from door station Push notification when bell rings

### 9.14 Connecting the video door module to ABUS NVR

The video image from the video door module can also be integrated into an ABUS NVR. The video is tapped using the RTSP protocol, which only enables permanent display or permanent recording (no motion detection or other types of event recording).

	Please note the data protection regulations prevailing at the installation site!
---	--

The following steps are necessary for the integration:

1. Creation of a user-defined protocol in the camera management of the ABUS NVR.
2. The following stream details are to be used:  
Protocol: RTSP  
Transfer protocol: Automatic

Port: 554 (standard port)  
Stream path: Streaming / Channels / 101 (Main Stream)  
Streaming / Channels / 102 (Sub Stream)

3. When adding a new channel to the NVR, this custom protocol will be selected for the video door module.

Username ("admin") and password are usually the same as the door station monitor. If the password was changed via the CMS software, this changed password must be used.

### 9.15 "Emergency door opener" button on door video module

A button/switch can be attached directly to the door video module via alarm input 3 (AIN 3 = relay 1) and alarm input 4 (AIN 4 = relay 2), which actuates when the door relay is engaged.

To enable alarm input 3 (AI3 and AI4), open the remote configuration for the respective door video module with the ABUS CMS software and set AI3 to "openDoorBtn"

The AIN3 for the door video module now opens the relay 1 door  
The AIN4 for the door video module now opens the relay 2 door

For security reasons, this function is disabled when the system is delivered.

The screenshot shows a configuration window titled "IO In Out". It is divided into two sections: "IO In" and "IO Out".

**IO In Section:**

- IO In No.: AI3 (dropdown menu)
- Use In: openDoorBtn (dropdown menu)

**IO Out Section:**

- IO Out No.: DOOR1 (dropdown menu)
- Use out: electricLock (dropdown menu)

At the bottom of the form is a "Save" button.

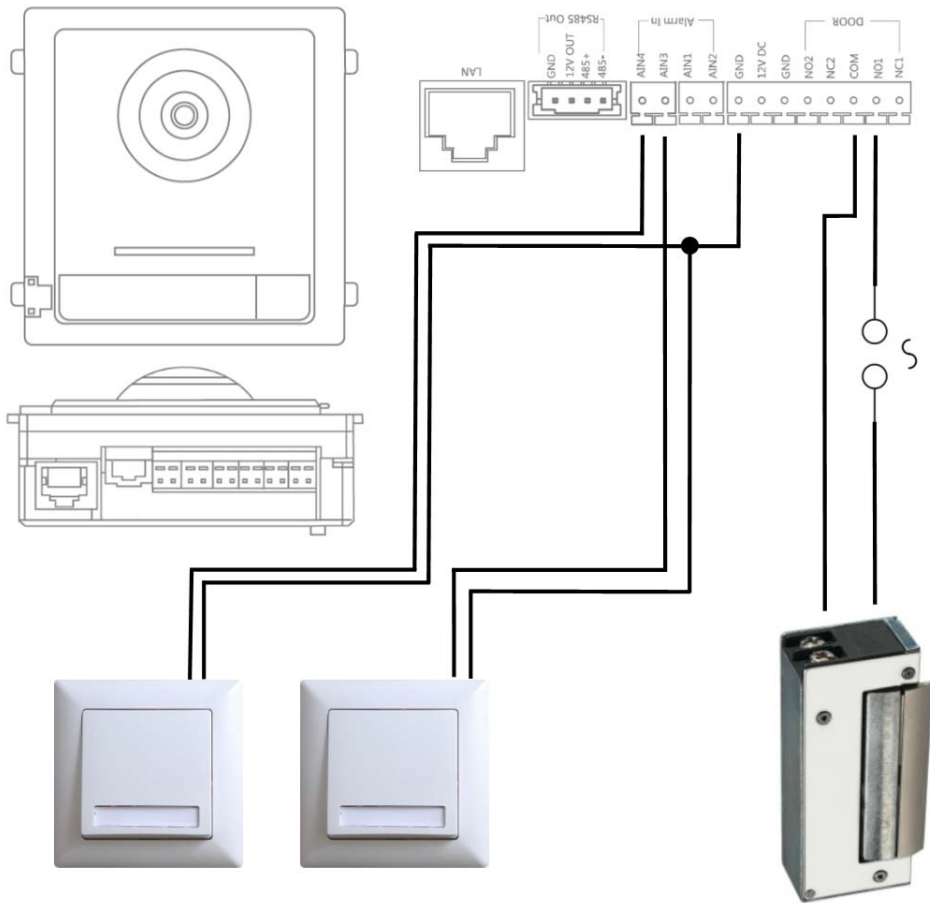

Max. 2A @ 30 VDC

Max. 0.5A @ 125 VAC

## 9.16 Relay connection

The door video module relay (TVHS20000(S) / TVHS20010(S)), security module TVHS10040 / TVHS20340 and monitors TVHS20200 / 210 / 220 have maximum loads of 2A 30VDC / 0.5A 125AC. An overload will cause the device to malfunction.

Be sure to determine the power consumption of your current door opener / motorised lock. If the permissible current is exceeded, we recommend connecting an external relay.

The door video module has a separate 12V DC voltage output. This allows an external auxiliary relay to be clamped on directly without further power supply.

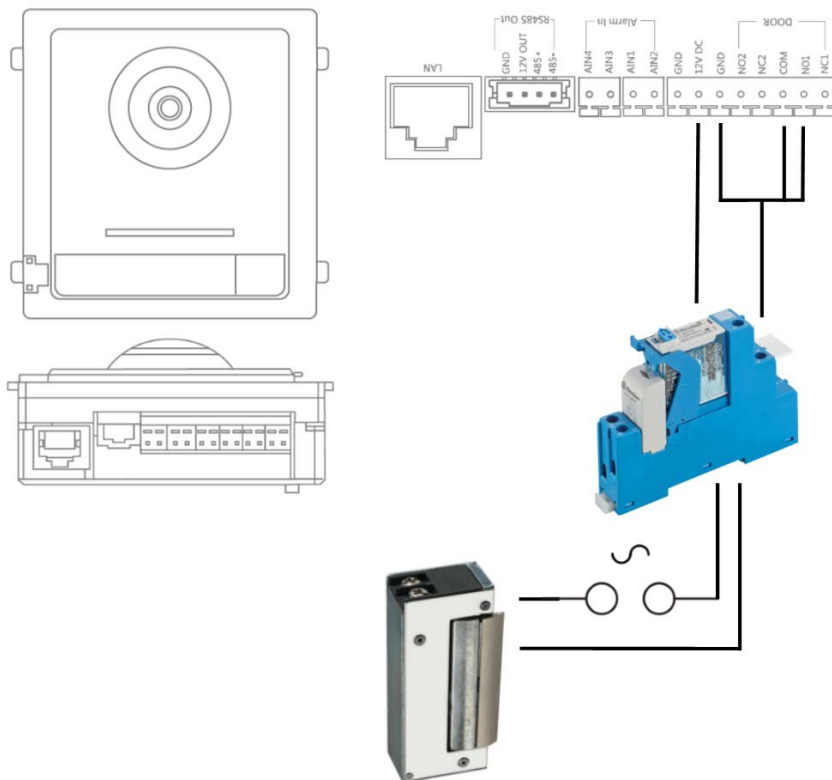

Hat rail relays:

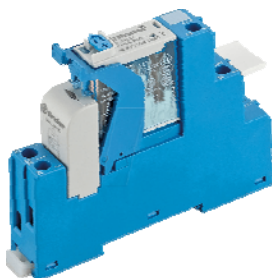

Example: Fully assembled 12V relay PCB with protective diode



### 9.17 Instructions for measuring the current door opener

If you would like to control an already existing door opener and do not have any information about the current consumption, determine whether the maximum power consumption will overload the relay before connecting to the door video module relay.

To do this, measure the power consumption using a multimeter. Separate a live cable and switch the ammeter in between (in series).

### 9.18 Application example "video module in front of every apartment door"

Often there is a desire to also place a video module in front of every apartment door in an apartment building in order to get a 180 ° video of the area in front of the apartment door (peepholes are usually very acute-angled in your field of vision).

This can be programmed for up to 16 apartment doors using the "Side entrance" function in the video module.

#### LAN Version

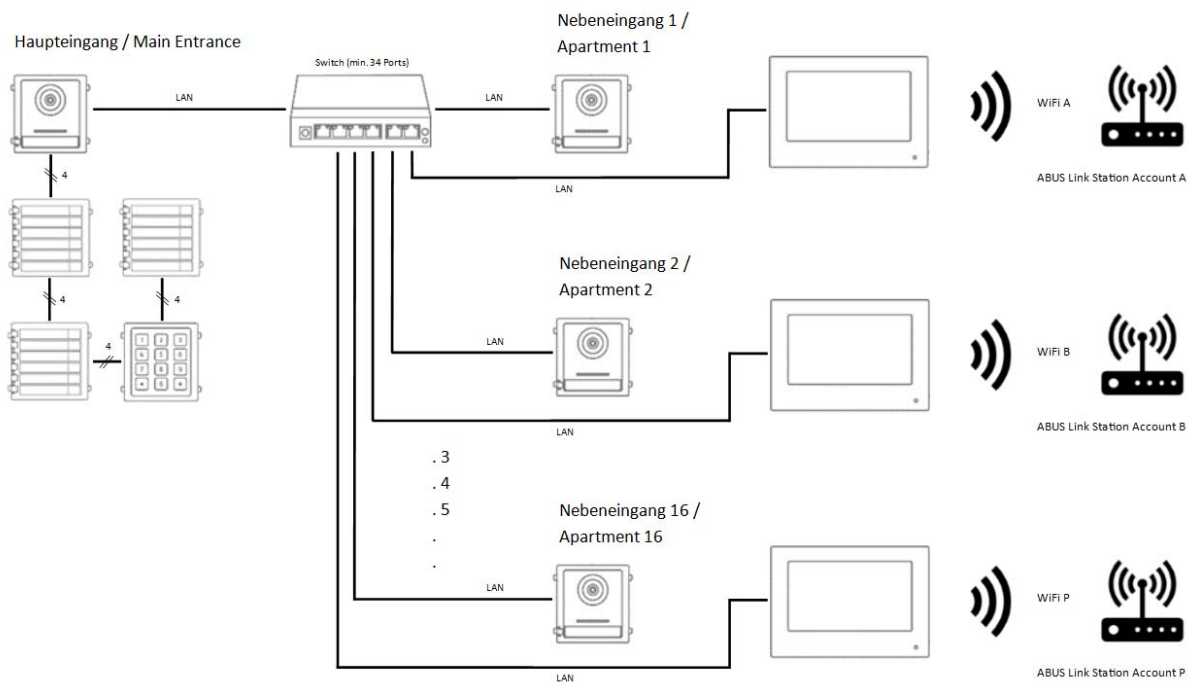



## 2-wire version

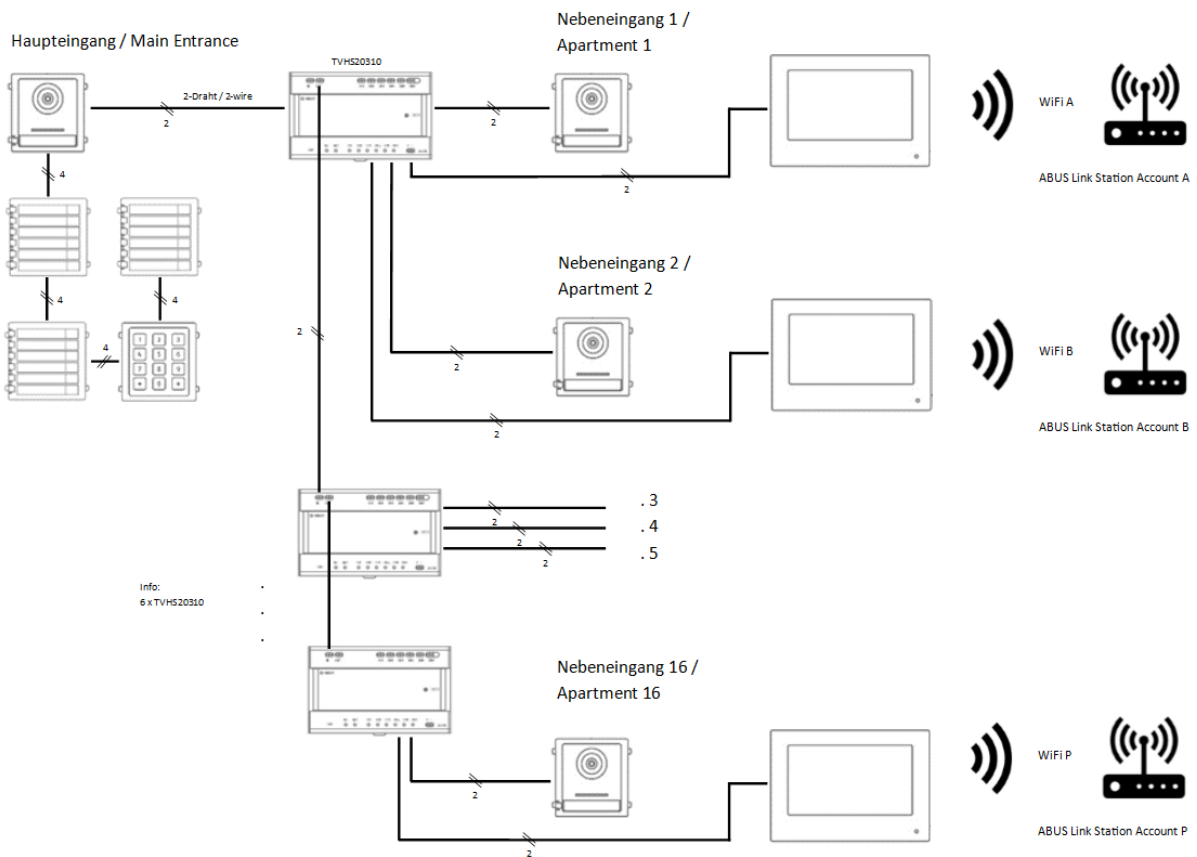

### Remote Configuration

- System
  - Device Information
  - General
  - Time
  - System Maintenance
  - User
  - RS485
- Intercom
  - ID Configuration
  - Time Parameters
  - Permission Password
  - Access and Elevator Control
  - IO Input/Output
  - Volume Input/Output
  - Dial
  - Motion Detection
  - Intercom Protocol
  - Sub Module
- Network
- Video Display
- CCD

#### Configuring the Room Numbers

**Device No. Configuration**

Device Type:

Project No.:

Community No.:

Building No.:

Floor No.:

No.:

**Reboot**

?

Master Outdoor Device to Slave Device will cause the device to reboot, Are you sure?

**Remote Configuration** ✕

**Configuring the Network and Sip Parameters**

**Linked Network Configuration**

Device Type:

Master Station IP Address:

(Main) Door Station IP Address:

SIP Server IP Address:

Security Control Panel IP Address:

Security Control Panel Port No.:

**Remote Configuration** ✕

**Configuring the Key Call Room Parameters**

**Dial**

Number:

Room No.:

Quick Press for Calling Center

### 9.19 Application example "Individual WiFi access"

In an apartment building, there is often no central Internet connection for all residential units. Each residential unit may have its own internet connection.

A connection to the customer-specific internet connection can be established via the WiFi function of the main monitor.

This means that there is also access to the ABUS Link Station function with push notification when the doorbell rings individually for each residential unit.

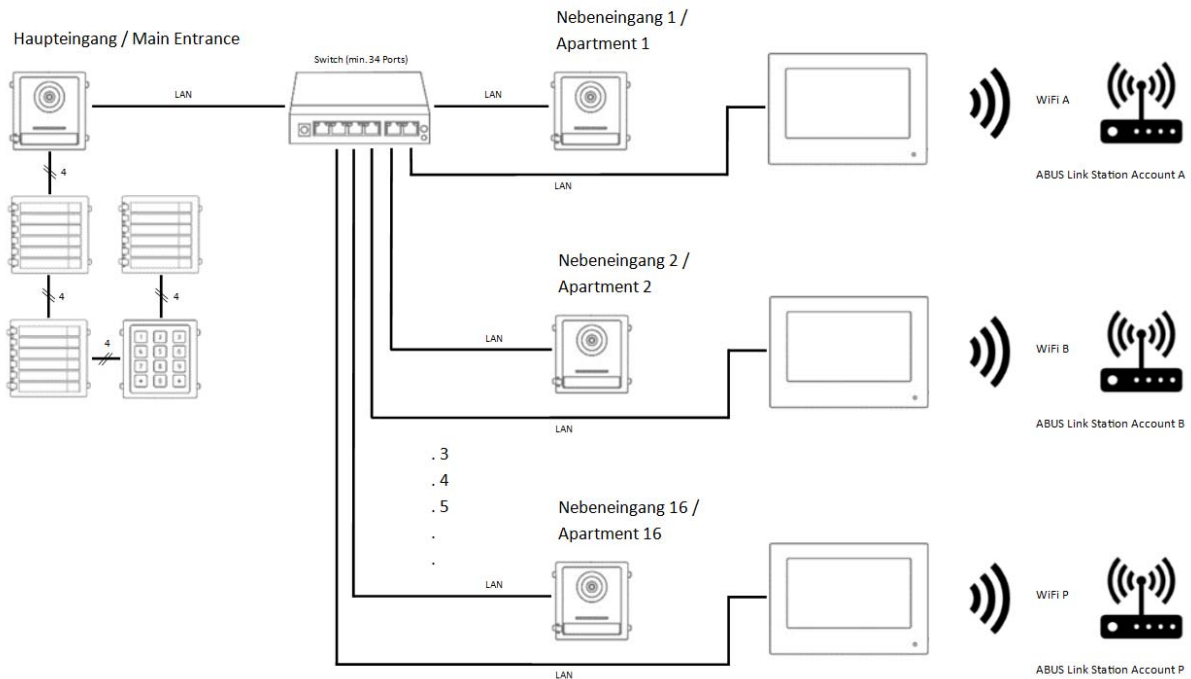

Wlan-Einstellungen		⚙️
📶	<input type="checkbox"/>	⚙️
MAX_MUSTERWLAN	📶	📶
		🔧

## **10. Wiring guidelines (2-wire)**

A document with further information on wiring the 2-wire door intercom system can be found at [www.abus.com](http://www.abus.com), e.g. on the TVHS20010 product:

[https://www.abus.com/var/ImagesPIM/d110001/medias/docus/25/Moduvis\\_Verkabelung\\_Wiring\\_2wire\\_V1.1.pdf](https://www.abus.com/var/ImagesPIM/d110001/medias/docus/25/Moduvis_Verkabelung_Wiring_2wire_V1.1.pdf)

# MODUVIS Interphone TVHS20XXX(S)



## Manuel d'utilisation

Version 06/2021 (V1.2)



*Traduction française du manuel original allemand. À conserver pour une utilisation ultérieure !*

## **FR Introduction**

Chère Cliente, cher Client,

Nous vous remercions d'avoir choisi ce produit.

### TVHS20000 / TVHS20000S

L'appareil est conforme aux exigences des directives européennes suivantes : directive CEM 2014/30/UE et directive RoHS 2011/65/UE.

### TVHS20010 / TVHS20010S

L'appareil est conforme aux exigences des directives européennes suivantes : directive CEM 2014/30/UE et directive RoHS 2011/65/UE.

### TVHS20020 / TVHS20020S

L'appareil est conforme aux exigences des directives européennes suivantes : directive CEM 2014/30/UE et directive RoHS 2011/65/UE.

### TVHS20030 / TVHS20030S

L'appareil est conforme aux exigences des directives européennes suivantes : directive CEM 2014/30/UE et directive RoHS 2011/65/UE.

### TVHS20040

L'appareil est conforme aux exigences des directives européennes suivantes : directive CEM 2014/30/UE et directive RoHS 2011/65/UE.

### TVHS20200

La société ABUS Security-Center déclare par la présente que l'appareil est conforme à la directive RED 2014/53/UE. En outre, les appareils sont conformes aux exigences des directives européennes suivantes : directive CEM 2014/30/UE et directive RoHS 2011/65/UE. Le texte complet de la déclaration de conformité UE est disponible à l'adresse Internet suivante : [www.abus.com/product/TVHS20200](http://www.abus.com/product/TVHS20200)

### TVHS20210

La société ABUS Security-Center déclare par la présente que l'appareil est conforme à la directive RED 2014/53/UE. En outre, les appareils sont conformes aux exigences des directives européennes suivantes : directive CEM 2014/30/UE et directive RoHS 2011/65/UE. Le texte complet de la déclaration de conformité UE est disponible à l'adresse Internet suivante : [www.abus.com/product/TVHS20210](http://www.abus.com/product/TVHS20210)

### TVHS20220

La société ABUS Security-Center déclare par la présente que l'appareil est conforme à la directive RED 2014/53/UE. En outre, les appareils sont conformes aux exigences des directives européennes suivantes : directive CEM 2014/30/UE et directive RoHS 2011/65/UE. Le texte complet de la déclaration de conformité UE est disponible à l'adresse Internet suivante : [www.abus.com/product/TVHS20220](http://www.abus.com/product/TVHS20220)

### TVHS10040 / TVHS20340

L'appareil est conforme aux exigences des directives européennes suivantes : directive CEM 2014/30/UE et directive RoHS 2011/65/UE.

Lorsque vous utilisez ce produit, respectez les consignes du manuel d'utilisation afin de ne pas altérer la conformité du produit et sa sécurité de fonctionnement !

Avant la mise en service du produit, veuillez lire le manuel d'utilisation dans son intégralité et respecter toutes les consignes d'utilisation et de sécurité !

**Tous les noms de sociétés et de produits mentionnés dans ce manuel sont des marques déposées de leurs propriétaires respectifs. Tous droits réservés.**

**Pour toute question, adressez-vous à votre installateur ou revendeur spécialisé.**



#### **Clause de non-responsabilité**

Ce manuel d'utilisation a été rédigé avec le plus grand soin. Si vous constatez malgré tout des omissions ou autres imprécisions, nous vous remercions de bien vouloir nous les signaler. La société ABUS Security-Center GmbH & Co. KG décline toute responsabilité pour les erreurs techniques ou typographiques et se réserve le droit de modifier à tout moment le produit et les manuels d'utilisation sans préavis.

ABUS Security-Center décline toute responsabilité pour les dommages directs et indirects liés à l'équipement, aux performances et à l'utilisation de ce produit. Le contenu de ce document ne fait l'objet d'aucune garantie.

## Consignes de sécurité importantes



**En cas de dommages consécutifs au non-respect de ce manuel d'utilisation, la garantie devient caduque. Nous déclinons toute responsabilité pour les dommages consécutifs !**



**Nous déclinons toute responsabilité pour les dommages matériels et/ou corporels consécutifs à une manipulation non conforme ou au non-respect des consignes de sécurité. Dans de tels cas, la garantie devient caduque !**

**Chère Cliente, cher Client,**

**Les consignes de sécurité et mises en garde suivantes sont destinées à la protection de votre santé ainsi qu'à la protection de l'appareil. Veuillez lire attentivement les points suivants :**

- Ce produit ne contient aucune pièce nécessitant un entretien de votre part. Par ailleurs, l'ouverture et le démontage de l'appareil annulent automatiquement la certification (CE) et la garantie.
- Une chute, même de faible hauteur, risque d'endommager le produit.

Évitez d'utiliser l'appareil dans les conditions ambiantes défavorables suivantes :

- lieu humide ou humidité élevée de l'air ;
- froid ou chaleur extrême ;
- exposition directe aux rayons du soleil ;
- poussières ou gaz, vapeurs ou solvants inflammables ;
- fortes vibrations ;
- champs magnétiques intenses, comme à proximité de machines ou de haut-parleurs.
- Il est interdit d'installer la caméra sur des surfaces instables.

Consignes de sécurité générales :

- Ne laissez pas traîner le matériel d'emballage ! Dans les mains d'un enfant, les films et sacs en plastique, les éléments en polystyrène, etc. peuvent devenir des jouets dangereux.
- Pour des raisons de sécurité, la caméra de vidéosurveillance doit être tenue hors de la portée des enfants en raison des petites pièces qu'ils pourraient avaler.
- N'introduisez jamais d'objets à travers les ouvertures de l'appareil.
- Utilisez uniquement les appareils auxiliaires/accessoires préconisés par le fabricant. Ne raccordez pas de produits incompatibles.
- Veuillez respecter les consignes de sécurité et les manuels d'utilisation des autres appareils raccordés.
- Avant de mettre l'appareil en service, vérifiez qu'il n'est pas endommagé. En cas de dommages, ne mettez pas l'appareil en service !
- Respectez les limites de la tension de service indiquées dans les caractéristiques techniques. Toute tension supérieure est susceptible d'endommager l'appareil et de compromettre votre sécurité (risque d'électrocution).



Avant d'installer l'appareil dans un système de vidéosurveillance existant, veillez à ce que tous les appareils soient déconnectés du secteur et du circuit basse tension.



En cas de doute, ne procédez pas vous-même au montage, à l'installation et au câblage, mais confiez-les à un professionnel qualifié. Toute intervention mal exécutée et réalisée par un non-professionnel sur le réseau électrique ou sur les installations domestiques peut être dangereuse, pour vous-même et pour autrui.

Les installations doivent être câblées de manière à ce que le circuit secteur et le circuit basse tension soient toujours séparés.

Ils ne doivent en aucun cas être reliés ou pouvoir être reliés suite à une erreur.



## **Table des matières**

<b>1.</b>	<b>UTILISATION CONFORME.....</b>	<b>157</b>
<b>2.</b>	<b>SIGNIFICATION DES PICTOGRAMMES .....</b>	<b>157</b>
<b>3.</b>	<b>APERÇU DU SYSTEME.....</b>	<b>158</b>
3.1	VARIANTE A 2 FILS .....	160
3.1.1	COMPOSANTS.....	160
3.1.2	TYPES DE CABLE RECOMMANDES .....	161
3.2	VARIANTE RESEAU IP .....	161
3.2.1	COMPOSANTS.....	161
3.3	COMPOSANTS DE L'INSTALLATION.....	162
3.4	VARIANTES DU SYSTEME .....	163
<b>4.</b>	<b>MISE EN SERVICE.....</b>	<b>168</b>
4.1	CABLAGE .....	168
4.1.1	HAUTEUR D'INSTALLATION .....	168
4.2	OPTIONS D'ACTIVATION / PREMIERE ATTRIBUTION DE MOT DE PASSE .....	169
4.2.1	ACTIVATION VIA L'ECRAN DE PLATINE DE RUE .....	169
4.2.2	ACTIVATION VIA LE RESEAU IP .....	172
4.2.3	REINITIALISATION DU MOT DE PASSE SUR L'ECRAN/MODULE DE PORTE VIDEO .....	172
<b>5.</b>	<b>UTILISATION DE L'ECRAN (2 FILS ET IP) .....</b>	<b>173</b>
5.1	IMAGE EN TEMPS REEL .....	173
5.2	VUE D'ENSEMBLE DE L'ECRAN D'ACCUEIL .....	174
5.2.1	OPTION DE MENU : REGLAGES D'APPEL .....	179
5.2.2	REGLAGES WI-FI .....	181
5.2.3	BOUTON D'ETAGE .....	182
5.2.4	AUTRES REGLAGES.....	183
5.2.4.1	CONFIGURATION – INFORMATIONS LOCALES .....	183
5.2.4.2	CONFIGURATION – REGLAGES DU RESEAU.....	187
5.2.4.3	CONFIGURATION – GESTION DES APPAREILS.....	188
5.2.4.4	CONFIGURATION – REGLAGES PAR DEFAUT .....	190
5.2.4	CONFIGURATION DE RELAIS.....	190
5.2.5	CARTE MICROSD .....	191
5.2.6	VERROUILLAGE DE L'ECRAN .....	191
5.2.7	INFORMATIONS DE L'APPAREIL.....	191
5.2.8	REGLAGE TEMPOREL .....	191
5.2.9	REDEMARRAGE DE L'APPAREIL .....	191
5.2.10	REGLAGES DU MOT DE PASSE (CODE PIN) .....	192
5.2.11	LANGUE DU SYSTEME.....	193
5.2.12	REGLAGE DE LA LUMINOSITE .....	193
5.2.13	BOUTON D'ETAGE .....	193
5.2.14	INFORMATIONS DE LICENCE OPEN SOURCE .....	193
<b>6.</b>	<b>MAINTENANCE ET NETTOYAGE.....</b>	<b>194</b>
6.1	TEST DE FONCTIONNEMENT.....	194
6.2	NETTOYAGE .....	194
<b>7.</b>	<b>ÉLIMINATION.....</b>	<b>194</b>

<b>8.</b>	<b>AVIS DE LICENCE OPEN SOURCE .....</b>	<b>194</b>
<b>9.</b>	<b>CONSIGNES D'INSTALLATION ET DE MISE EN SERVICE .....</b>	<b>195</b>
9.1	UTILISATION DU MODULE DE SECURITE (TVHS10040 / TVHS20340) .....	195
9.2	CONFIGURATION DES ENTREES SECONDAIRES .....	196
9.3	CONFIGURATION DE BOUTONS DE SONNETTE SUPPLEMENTAIRES (TVHS20020) POUR LES IMMEUBLES D'HABITATION .....	198
9.4	REGLAGE DU VOLUME SUR LE MODULE VIDEO DE PORTE (TVHS20000, TVHS20010) .	201
9.5	RACCORDEMENT D'UNE SONNETTE EXISTANTE.....	202
9.6	RACCORDEMENT D'UNE GACHE EXISTANTE A L'ECRAN DE LA PLATINE DE RUE .....	203
9.7	RACCORDEMENT D'UN BOUTON DE SONNETTE D'ETAGE A L'ECRAN PRINCIPAL .....	204
9.8	RACCORDEMENT D'UNE GACHE ELECTRIQUE AU MODULE VIDEO (Y COMPRIS « PORTE DU JARDIN »).....	205
9.9	IMPORTATION DE VOS PROPRES SONNERIES DANS L'ECRAN DE LA PLATINE DE RUE .....	207
9.10	ABUS CMS : MISE A JOUR DU FIRMWARE DES COMPOSANTS MODUVIS.....	208
9.11	ABUS CMS : REGLAGES AVANCES.....	210
9.12	ÉTENDUE DES FONCTIONS MODUVIS ET APPLICATION ABUS LINK STATION.....	214
9.13	COMPATIBILITE AVEC LES PRODUITS ABUS .....	214
9.14	INTEGRATION DU MODULE DE PORTE VIDEO DANS ABUS NVR.....	214
9.15	BOUTON « GACHE D'URGENCE » SUR LE MODULE VIDEO DE PORTE.....	215
9.16	CIRCUIT RELAIS .....	217
9.17	INSTRUCTIONS DE MESURE DE LA GACHE EXISTANTE.....	218
<b>10.</b>	<b>GUIDE DE CABLAGE (2 FILS).....</b>	<b>222</b>

## **1. Utilisation conforme**

MODUVIS est un système d'interphone avec affichage vidéo de la zone de porte. L'installation peut être installée dans des maisons individuelles et des immeubles. Avec des écrans d'extension dans une unité d'habitation, le système peut également servir d'interphone (sans vidéo) dans cette unité.

L'interphone MODUVIS n'est pas un système de vidéosurveillance et ne doit pas être utilisé comme tel.



Toute utilisation différente de celle décrite ci-dessus peut entraîner une dégradation du produit et occasionner d'autres dangers. Tout autre usage est considéré comme non conforme et entraîne la perte de la garantie ; toute responsabilité est alors exclue. Cela vaut également si le produit a fait l'objet de transformations et/ou d'autres modifications.

Veillez lire le manuel utilisateur attentivement et dans son intégralité avant de mettre le produit en service. Il contient des informations importantes concernant le montage et l'utilisation.

## **2. Signification des pictogrammes**



Le pictogramme représentant un éclair dans un triangle indique un danger pour la santé, par exemple une décharge électrique.



Le pictogramme représentant un point d'exclamation dans un triangle indique la présence, dans ce manuel d'utilisation, d'instructions importantes devant être impérativement respectées.



Ce pictogramme indique la présence de conseils et de remarques spécifiques relatifs à l'utilisation.

### 3. Aperçu du système

Cet interphone est disponible avec deux technologie de câblage :

Variante 2 fils : La communication et la tension d'alimentation transitent par deux fils (1 paire). Le câblage est réalisé en étoile, un répartiteur à 2 fils représente le point central.  
Un système de base comprend un répartiteur à 2 fils, un écran à 2 fils et un module vidéo à 2 fils.

Variante IP : La communication et la tension d'alimentation transitent via le câble (réseau) Ethernet. Les composants prennent en charge l'alimentation électrique par câble Ethernet (Power over Ethernet ou PoE) (en option 12 VDC). Le câblage est réalisé en étoile, le commutateur (PoE) étant le point central.  
Un système de base comprend un écran IP et un module vidéo IP.

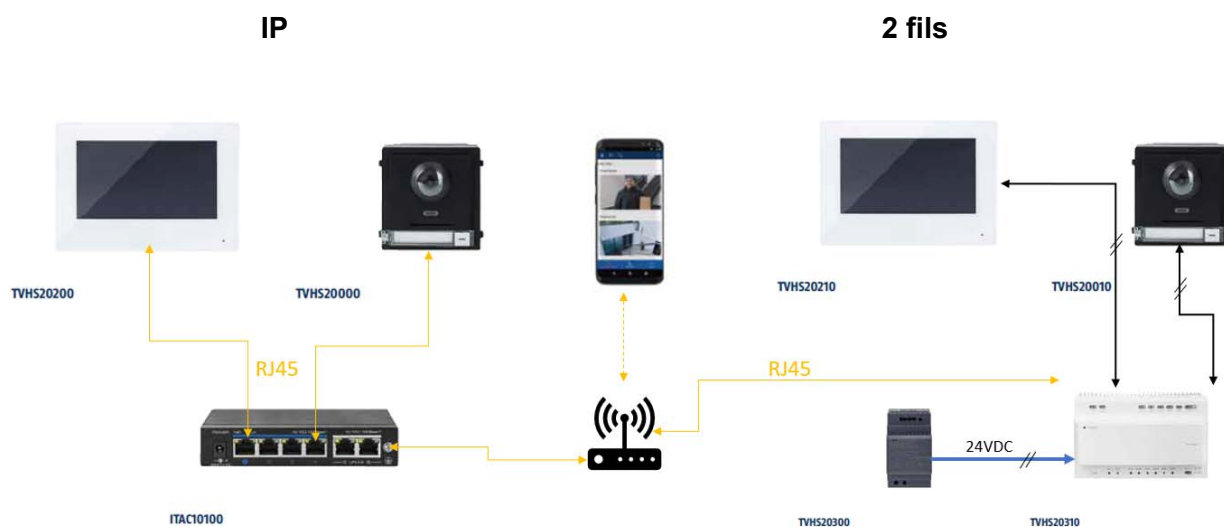

**Les deux variantes du système peuvent être combinées. Ceci permet une adaptation optimale aux conditions sur site.**

Exemples de systèmes combinés:

Cet exemple montre le fonctionnement mixte d'un moniteur principal via 2 fils et d'un moniteur d'extension via WiFi:

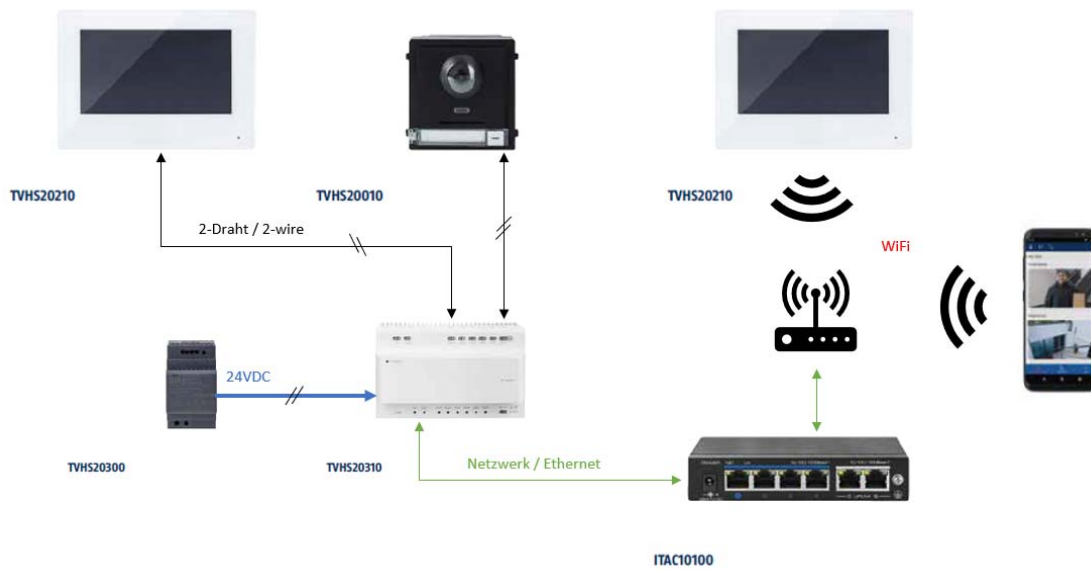



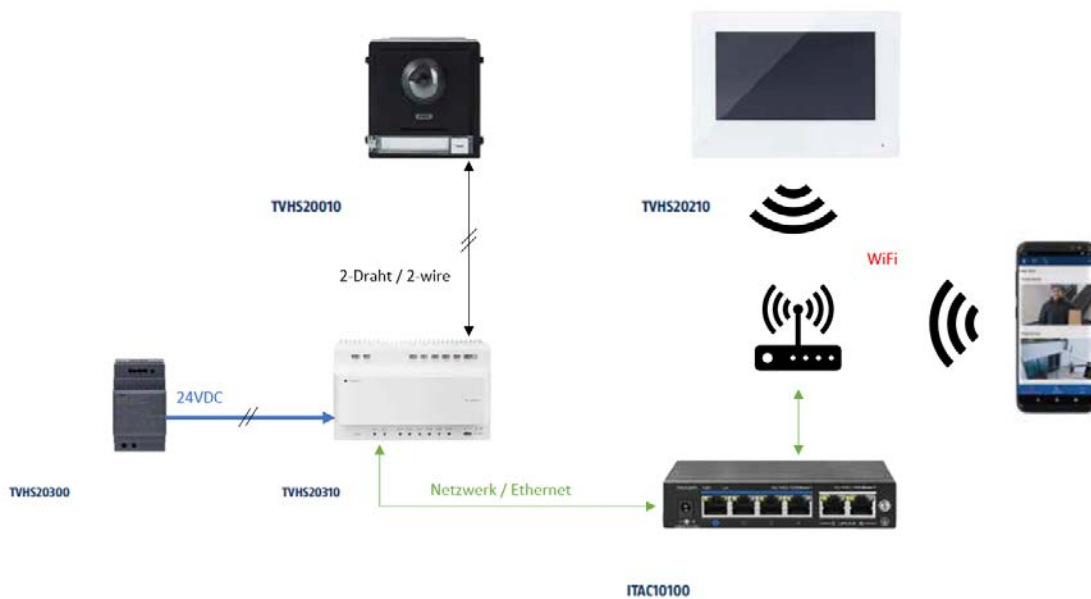





Cet exemple montre le fonctionnement mixte d'un module de porte vidéo via 2 fils avec un moniteur principal via WiFi.

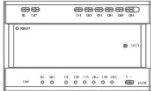

### 3.1 Variante à 2 fils

#### 3.1.1 Composants

<p>TVHS20210</p>  <p>Écran à 2 fils</p>	<p>TVHS20010 / TVHS20010S</p>  <p>Module vidéo à 2 fils</p>	<p>TVHS20310</p>  <p>Répartiteur à 2 fils</p>
<p>TVHS20020 / TVHS20020S</p>  <p>Module boutons de sonnette (6 boutons)</p>	<p>TVHS20030 / TVHS20030S</p>  <p>Clavier numérique</p>	<p>TVHS20040</p>  <p>Module d'information</p>
<p>TVHS20300</p>  <p>Alimentation 24 VDC pour profilé chapeau</p>	<p>TVHS10040 / TVHS20340</p>  <p>Module de sécurité</p>	

### 3.1.2 Types de câble recommandés

Choisissez le type de câble en fonction de la distance entre le module vidéo, le répartiteur et l'écran.

Module vidéo à 2 fils (TVHS20010 / TVHS20010S)





Écran à 2 fils (TVHS20210)

Répartiteur à 2 fils (TVHS20310)

Type de câble	24 AWG (10 Ω pour 100 m)	20 AWG (7 Ω pour 100 m)	18 AWG (4 Ω pour 100 m)
<b>Chemin de câble</b>			
TVHS20310 / TVHS20310	Max. 60 m	Max. 60 m	Max. 60 m
TVHS20010(S) / TVHS20310	Max. 35 m	Max. 60 m	Max. 60 m
TVHS20210 / TVHS20310	Max. 35 m	Max. 60 m	Max. 60 m









## 3.2 Variante réseau IP

### 3.2.1 Composants

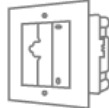
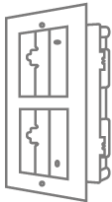
TVHS20200 / TVHS20220 " data-bbox="185 575 290 630"/> Écran PoE IP 7"/10"	TVHS20000 / TVHS20000S  Module vidéo IP	TVHS20020 / TVHS20020S  Module boutons de sonnette (6 boutons)
TVHS20030 / TVHS20030S  Clavier numérique	TVHS20040  Module d'information	TVHS10040 / TVHS20340  Module de sécurité

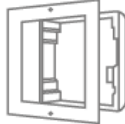
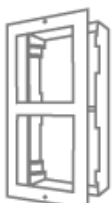
### 3.3 Composants de l'installation

Ces composants d'installation peuvent être utilisés pour la variante à 2 fils et la variante IP de l'interphone vidéo Moduvis

<p>TVHS20050</p>  <p>Couvercle module vide</p>	<p>TVHS20060</p>  <p>Couvercle pour bouton de sonnette inutilisé</p>	<p>TVHS20100(S)</p>  <p>Cadre pour 1 module encastré</p>
<p>TVHS20110(S)</p>  <p>Cadre pour 2 modules encastrés</p>	<p>TVHS20120(S)</p>  <p>Cadre pour 3 modules encastrés</p>	<p>TVHS10130(S)</p>  <p>Cadre pour 1 module en applique</p>
<p>TVHS10140(S)</p>  <p>Cadre pour 2 modules en applique</p>	<p>TVHS10150(S)</p>  <p>Cadre pour 3 modules en applique</p>	<p>TVHS20160</p>  <p>Boîtier extérieur pour cadre en applique (1 module)</p>
<p>TVHS20170</p>  <p>Boîtier extérieur pour cadre en applique (2 modules)</p>	<p>TVHS20180</p>  <p>Boîtier extérieur pour cadre en applique (3 modules)</p>	

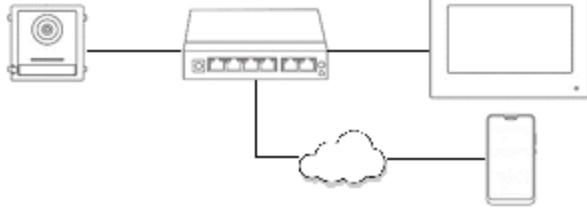
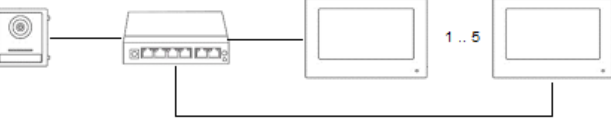
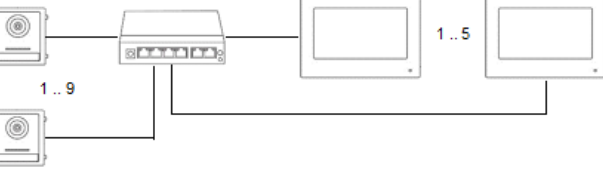
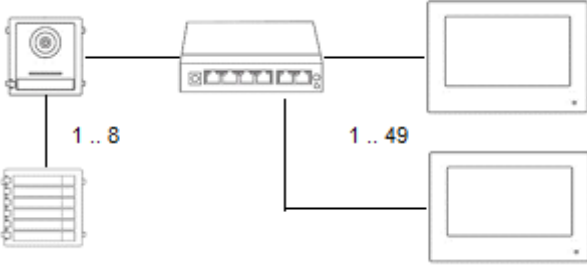

### 3.4 Variantes du système

N°	Technologie / Câblage	Structure du système	Exemple d'application
1	IP		Maison individuelle
2	IP		Maison individuelle avec accès à l'application
3	IP		Maison individuelle avec écrans d'extension intérieurs
4	IP		Maison individuelle avec écrans d'extension intérieurs et entrées secondaires
5	IP		Immeuble d'habitation
6	IP		Immeuble d'habitation avec écrans d'extension intérieurs

7	IP		<b>Immeuble d'habitation avec écrans d'extension intérieurs et module clavier numérique</b>
8	IP		<b>Immeuble d'habitation avec écrans d'extension intérieurs, module clavier numérique et module d'information éclairé</b>
9	2 fils		<b>Maison individuelle</b>
10	2 fils		<b>Maison individuelle avec entrée latérale</b>
11	2 fils		<b>Maison individuelle avec accès à l'application</b>

12	2 fils		<b>Maison individuelle avec écrans d'extension intérieurs</b>
13	2 fils		<b>Maison individuelle avec écrans d'extension intérieurs et entrées secondaires</b>
14	2 fils		<b>Immeuble d'habitation</b>

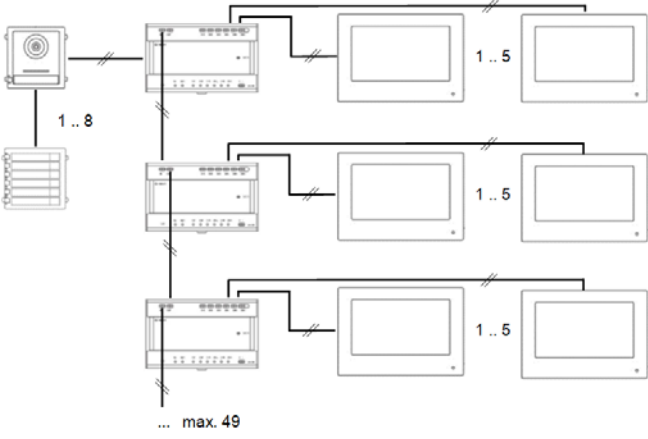
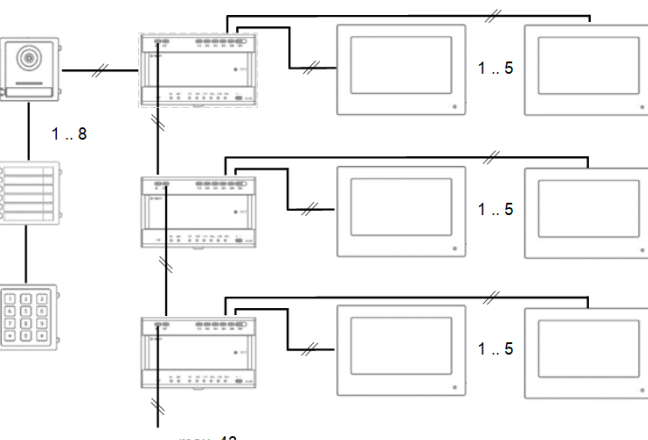
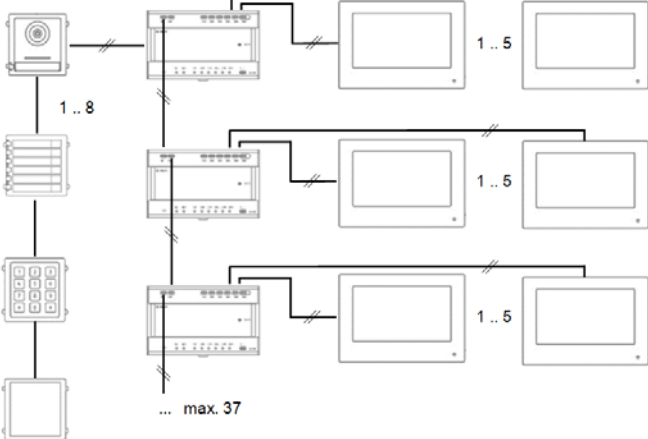
15	2 fils	 <p>... max. 49</p>	<b>Immeuble d'habitation avec écrans d'extension intérieurs</b>
16	2 fils	 <p>... max. 43</p>	<b>Immeuble d'habitation avec écrans d'extension intérieurs et module clavier numérique</b>
17	2 fils	 <p>... max. 37</p>	<b>Immeuble d'habitation avec écrans d'extension intérieurs, module clavier numérique et module d'information éclairé</b>

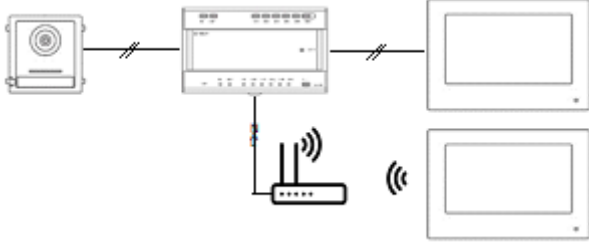
18	2 fils / IP		<p><b>Combinaison 2 fils et technologie IP :</b></p> <p>écran d'extension intérieur par connexion Wi-Fi</p>
----	-------------	--	---

	<p><b>REMARQUE :</b></p> <p>Chaque écran et chaque module vidéo de porte apparaît dans le réseau de façon autonome et possède sa propre adresse IP. Peu importe que les systèmes soient connectés via le réseau PoE ou raccordés au « répartiteur à 2 fils » avec la variante 2 fils. L'écran « TVHS20200 / TVHS20220 » peut également être intégré au réseau via le réseau sans fil.</p>
---	---

	<p><b>REMARQUE:</b></p> <p>Chaque appareil terminal doit être connecté directement à l'unité de distribution. Le transfert d'un moniteur à un autre n'est pas autorisé.</p>
---	---

## **4. Mise en service**

### **4.1 Câblage**

Consultez les guides de démarrage rapide fournis avec les produits pour connaître les instructions de câblage. Les brèves instructions peuvent également être trouvées en utilisant la recherche de produits sur [www.abus-sc.de](http://www.abus-sc.de).

#### **4.1.1 Hauteur d'installation**

La hauteur d'installation du module vidéo TVHS20000 ou TVHS20010 ne doit pas être inférieure à 1,40 m (bord supérieur). Sinon, il peut arriver que des personnes se tenant trop près du module vidéo ne puissent pas être reconnues par leur visage.

## 4.2 Options d'activation / première attribution de mot de passe

### 4.2.1 Activation via l'écran de platine de rue

- 1) Mettez le système sous tension et assurez-vous que la platine de rue se trouve dans le même réseau.

Saisissez un mot de passe lors de la configuration initiale de l'écran. Ce mot de passe est également utilisé automatiquement pour activer la platine de rue. Le mot de passe est également requis pour la zone protégée par mot de passe de l'écran.

- 8-16 caractères
- caractères valides : chiffres, minuscules, majuscules, caractères spéciaux ( ! \$ % & / ( ) = ? + - )
- 2 types de caractère doivent être utilisés

- 2) Sélectionnez la langue souhaitée et confirmez en cliquant sur « SUIVANT ».

	Assistant langue 1/4
English	
Deutsch	
Italiano	
Français	
Néerlandais	

	<b>Note de publication du micrologiciel</b>
	Fonction: langue néerlandaise
	Module vidéo (THVS20000(S) / TVHS20010(S)): V2.2.3_build_201029 Moniteur (TVHS20200 / 210 / 220): V2.1.2_build_201029

- 3) Faites votre choix entre DHCP / adresse IP fixe. Il est fortement recommandé d'attribuer une adresse IP fixe à chaque appareil autonome. À défaut, une nouvelle adresse IP pourrait être attribuée en cas de coupure de courant, ce qui peut entraîner de graves dysfonctionnements du système.

	Assistant réseau 2/4
DHCP	<input type="checkbox"/>
IP locale	192.168.0.11

Masque de sous-réseau	255.255.255.0
Passerelle	192.168.0.1

	<p><b>Remarque</b></p> <p>Lorsque vous appuyez sur le commutateur pour la fonction DHCP, le commutateur saute d'abord vers la droite, puis à nouveau vers la gauche. À ce moment, une adresse IP est obtenue du serveur DHCP, qui est alors définie comme adresse IP fixe dans l'appareil.</p>
---	--

4) Sélectionnez le type d'écran que vous souhaitez configurer.

<	Assistant réseau 3/4	
Type de platine intérieure intérieure	Platine	>
Étage	0	
N° d'appartement	1	

#### **Platine intérieure :**

Cet écran représente le moniteur principal de l'interphone. Peu importe qu'il s'agisse d'une maison individuelle ou d'un immeuble d'habitation. L'écran principal d'un appartement doit toujours être configuré avec le type « Platine intérieure ». Si vous n'utilisez qu'un seul bouton de sonnette et un appartement, le numéro de l'appartement reste « 1 ». Dès que plusieurs appartements / écrans principaux sont utilisés, les numéros d'appartement doivent être ajustés.

Exemple : Appartement 1 => numéro d'appartement 1  
Appartement 2 => numéro d'appartement 2  
(etc.)

C'est la seule manière d'attribuer les boutons sonnette aux différents foyers.

**Remarque :** un écran principal (platine intérieure) doit toujours être relié à la platine de rue principale dans le système.

#### **Extension intérieure :**

L'écran fait office d'écran d'extension dans un système afin d'équiper d'autres pièces d'une habitation. Tous les écrans d'extension sont associés à l'écran principal et affichent les mêmes fonctions que l'écran principal en cas d'activation de la sonnette.

Vous pouvez associer cinq écrans supplémentaires maximum à un écran principal. (N°1-5). Il est également possible d'attribuer un « nom de pièce ». Ce dernier s'affiche automatiquement sous « Contacts » sur les autres écrans du système.





**Remarque :** un écran d'extension (extension intérieure) doit toujours être associé à l'écran principal dans le système !

Avec le type d'installation « Extension intérieure », les options suivantes sont indisponibles sur l'écran. **Elles sont réglables/consultables uniquement sur l'écran principal du système :**

- Activer/désactiver l'« acceptation automatique » du répondeur.
- Écouter les messages du répondeur
- Application ABUS LINK Station – Menu
- Ajouter des caméras réseau
- Configuration de l'adresse réseau et définition des réglages d'usine sur les périphériques

5) « Assistant appareils connectés »

Assistant appareils connectés			
Rechercher par numéro de série			
Référence ABUS 	Adresse IP	Version du firmware	Activer
Référence ABUS 	Adresse IP	Version du firmware	Activer
Référence ABUS 	Adresse IP	Version du firmware	Activer

Ici s'affichent les appareils réseau disponibles de la série de platines de rue TVHS20xxx.

En cas de configuration d'un écran principal, il convient de sélectionner ici la platine de rue principale.

En cas de configuration d'une extension intérieure, il convient de sélectionner ici l'écran principal.

Vous avez également la possibilité d'« activer » la platine de rue. L'écran principal active alors automatiquement la platine de rue avec le même mot de passe de l'écran.

Pour cela, sélectionnez la platine de rue principale dans la liste puis cliquez sur « Activer ». Une fois l'activation effectuée, sélectionnez la platine de rue. Une coche de confirmation verte s'affiche à gauche de la liste. La platine de rue est maintenant activée et correctement associée.

Si aucun appareil n'est trouvé sur le réseau, assurez-vous que la platine de rue se trouve dans le même réseau et qu'elle est sous tension.

Les réglages IP des appareils s'ouvrent avec la « molette » correspondante. Elle permet d'adapter l'adresse IP du module vidéo de porte.

Pour ajouter des entrées secondaires en plus d'une porte, consultez le chapitre « 9.2 Configuration des entrées secondaires » sous Consignes d'installation et de mise en service.

#### **4.2.2 Activation via le réseau IP**

Installez et démarrez l'installateur ABUS IP accessible sur le site Internet [www.abus.com](http://www.abus.com) pour le produit correspondant.

Chaque appareil connecté doit maintenant s'afficher dans la liste de sélection, éventuellement avec une adresse IP qui ne correspond pas au réseau cible.

Tout d'abord, il convient d'activer chaque appareil, c'est-à-dire qu'un mot de passe sécurisé doit être attribué à l'utilisateur principal « admin ». Un mot de passe sécurisé doit remplir les critères suivants :

- 8 à 16 caractères
- Caractères valides : chiffres, minuscules, majuscules, caractères spéciaux ( ! \$ % & / ( ) = ? + - )
- 2 types de caractères minimum doivent être utilisés.

Les réglages IP de la caméra peuvent être modifiés via l'installateur IP.

Le bouton « Navigateur » n'est pas disponible pour les composants de l'interphone car ils ne disposent pas de leur propre serveur Web.

La programmation des composants peut être effectuée en grande partie via l'écran de l'interphone. Pour les systèmes plus complexes, la programmation avec le logiciel CMS est toutefois nécessaire (intégration d'un composant comme un appareil IP, accès à l'option « Configuration à distance »).





	<p>L'activation dans le réseau IP peut également s'effectuer via le logiciel ABUS CMS.</p> <p>Le logiciel ABUS CMS peut être nécessaire pour certaines étapes de configuration supplémentaires.</p>
---	---

#### **4.2.3 Réinitialisation du mot de passe sur l'écran/module de porte vidéo**

Pour réinitialiser le mot de passe depuis l'écran ou le module de porte vidéo, veuillez contacter notre support technique.

## 5. Utilisation de l'écran (2 fils et IP)

### 5.1 Image en temps réel

Bouton / affichage	Description
	Répond à l'appel et établit la communication vidéo/vocale.
	Met fin à un appel et raccroche.
	Enregistre un instantané de l'image vidéo actuelle
	<p>Ouvre la porte. Si plusieurs sorties de relais sont utilisées en même temps, il y a jusqu'à 3 symboles de clé. (2x relais de porte dans le module vidéo de porte, 1x relais de porte dans l'écran).</p> <p>Pour obtenir de l'aide pour connecter une gâche au relais ou utiliser le module de sécurité TVHS10040, consultez la section <u>Consignes d'installation et de mise en service</u> des chapitres « 9.8 Raccordement d'une gâche électrique au module vidéo (y compris « porte du jardin ») » et « 9.1 Utilisation du module de sécurité (TVHS10040 / TVHS20340) »</p>

## 5.2 Vue d'ensemble de l'écran d'accueil

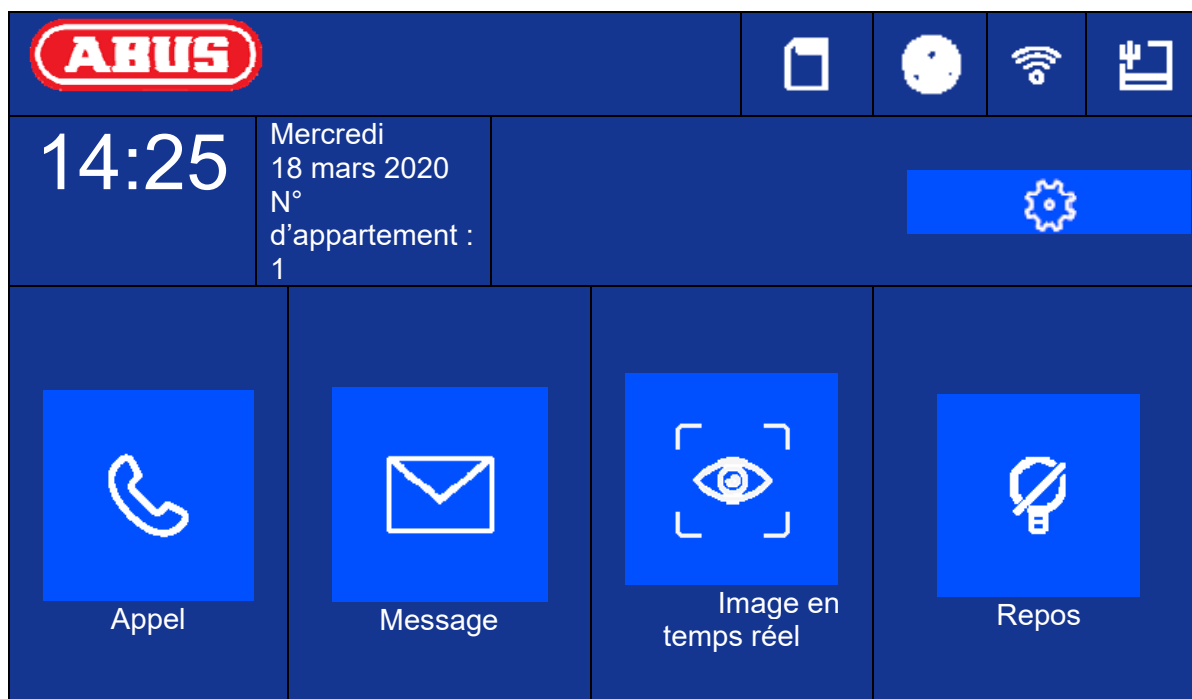





Bouton / affichage	Description
Heure	Affichage de l'heure  Appuyez une fois sur la zone d'affichage pour ouvrir le dialogue de réglage de la date et de l'heure.
Jour de semaine / date	Affichage du jour de semaine actuel Affichage de la date
Numéro d'appartement	Affichage des numéros d'appartement configurés de cette platine intérieure. Max. 49 appartements par système.
[ Appel ]	Communication vocale (sans vidéo) avec la platine intérieure ou l'extension intérieure.  Afficher/gérer les contacts  Consulter le compte rendu des appels (y compris les informations sur la platine de sonnette, l'image, la date, l'heure)
[ Message ]	Informations, messages des visiteurs et images de la réception des appels
[ Image en temps réel ]	Afficher l'image en temps réel des platines de rue connectées et des caméras réseau configurées
[ Réglages / Molette ]	Réglages d'appel généraux : sonnerie, durée de la sonnerie, durée de l'appel, renvoi d'appel, volume du microphone, volume de la sonnerie, volume de l'appel, tonalité des touches, réception automatique, mode Ne pas déranger

	Réglages Wi-Fi pour l'écran (à utiliser uniquement avec la variante IP !)  Autres réglages d'appareil : configuration (système), comportement du relais, carte microSD, heure, luminosité de l'écran
[ Repos ]	Désactiver immédiatement l'écran







## Appel

Initier des appels entre les appartements ou les écrans d'extension. Il est également possible de créer des contacts ici. Une extension intérieure est automatiquement créée.

<	*Entrer le numéro (0-0 pour la platine intérieure, 0-1 pour la platine intérieure extension n°1)				
1	2	3	-		
4	5	6	0		
7	8	9			

















## Liste de contacts

Ici, vous pouvez modifier ou supprimer les contacts créés. Pour supprimer, appuyez pendant trois secondes sur la ligne du contact. Un menu de suppression des contacts s'affiche alors.



	Liste de contacts		
Pièce 1			
			

## Compte rendu des appels

Affiche les appels entrants/activations de la sonnette. Il est également possible d'accéder directement à un instantané.





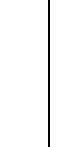

	Compte rendu des appels			
	Platine de rue principale		14-03-2020 11:21:08	
	Platine de rue principale		14-03-2020 10:55:37	
	Platine de rue principale		14-03-2020 10:55:37	
	Platine de rue principale		14-03-2020 10:55:37	
	Platine de rue principale		14-03-2020 10:55:37	
	Platine de rue principale		14-03-2020 09:55:37	

## Remarque

	Remarque		
Aucune remarque	...		 













## Message des visiteurs (répondeur)

Il est possible d'écouter ici les messages audio du répondeur si cet équipement est disponible et activé.

<		Message des visiteurs		  
N°1		14-03-2020 10:47:35		
N°2		13-03-2020 14:47:39		
N°3		13-03-2020 14:26:06		
				

### Journal des images

Vous trouverez ici un aperçu des images classées par jour

<		Journal des images			  
14-03					
					
					
					



### 5.2.1 Option de menu : Réglages d'appel

<	Réglages d'appel			>	
Sonnerie	Sonnerie 6	>			
Activer la sonnerie	<input type="checkbox"/>				
Durée de la sonnerie		30 s			
Durée de l'appel		30 s			
Renvoi d'appel		0 s			
Volume du microphone		10 %			
Volume de la sonnerie (écran)		70 %			
Volume de conversation		10 %			
Son des touches	<input type="checkbox"/>				
Réception automatique	<input type="checkbox"/>				
Acceptation automatique immédiate	<input type="checkbox"/>				
Mode Ne pas déranger	Platine intérieure	>			
Ne pas déranger	Toute la journée	>			

Bouton / affichage	Description
Sonnerie (1~6) :	Choisissez entre les six sonneries standard.
Activer la sonnerie :	Ici vous pouvez activer la sonnerie ou la couper.
Durée de la sonnerie (1~60s) :	Détermine la durée de la sonnerie en cas d'appel entrant. À l'issue du délai déterminé, la sonnerie se coupe automatiquement L'appel reste actif.
Durée de l'appel (1~60 s) :	Détermine la durée de l'appel. À l'issue du délai défini, l'appel entrant est automatiquement terminé.
Renvoi d'appel (0~20 s) :	Le renvoi d'appel retarde l'appel de l'application ABUS Link Station. Exemple : 10







	secondes. Après activation de la sonnette, l'écran de la platine de rue sonne immédiatement, mais ABUS LINK Station est appelée 10 secondes plus tard.
Volume du microphone (0~100 %) :	Veillez régler ici le volume du microphone de l'écran. Plus le pourcentage est élevé, plus le microphone de l'écran est fort (plus sensible).
Volume de la sonnerie (écran) (0~100 %) :	Réglez ici le volume de la sonnerie de l'écran.
Volume de conversation (10~100 %) :	Veillez régler ici le volume de conversation souhaité sur l'écran
Son des touches :	Active le son des touches lorsque vous appuyez sur l'écran tactile.
Réception automatique :	Si la fonction est activée, le système d'interphone de porte accepte l'appel avec le répondeur une fois la sonnerie expirée (durée de la sonnerie).
Acceptation automatique immédiate	Si la fonction est activée, l'interphone répond automatiquement à l'appel avec le répondeur lorsque la sonnette retentit.  Si la fonction est désactivée, le répondeur accepte automatiquement l'appel après la durée d'appel définie.
Mode Ne pas déranger :	Platine intérieure : Les appels des platines de rue et des écrans d'extension sont autorisés. Les appels des appartements tiers ne sont pas autorisés. Pour autoriser les appels des appartements, veuillez régler la fonction « Ne pas déranger » sur « Désactivé ».  Tous : Tous les appels sont refusés. (Appels de platine de rue, écran d'extension ou autre appartement)
Ne pas déranger :	Désactivé, toute la journée, programme (tous les jours de-à heure / minute). Détermine à quelle période la fonction « Ne pas déranger » est active.

Pour continuer d'utiliser une sonnette de porte/un carillon existant(e), consultez le chapitre « 9.5 Raccordement d'une sonnette existante » et la section Consignes d'installation et de mise en service.

Pour en savoir plus sur le réglage du volume du module de portée vidéo, consultez le chapitre « 9.4 Réglage du volume sur le module vidéo de porte (TVHS20000, TVHS20010) ».

Pour importer vos propres sonneries sur les écrans, consultez le chapitre « 9.9 Importation de vos propres sonneries dans l'écran de la platine de rue ».

## 5.2.2 Réglages Wi-Fi

	Réglages Wi-Fi	
		
MAX_DUPONTWIFI		
		

Bouton / affichage	Description
Activation/désactivation	Activation/désactivation de l'interface Wi-Fi de l'écran
Liste des réseaux Wi-Fi	Vous trouverez ici les réseaux Wi-Fi disponibles dans votre environnement. Après avoir sélectionné l'un d'entre eux, vous êtes invité(e) à saisir le mot de passe Wi-Fi. Une fois la connexion établie, une coche de confirmation verte s'affiche devant le réseau sélectionné.
Icône d'information Wi-Fi	Ici s'affichent les paramètres Wi-Fi, comme le nom du réseau, l'intensité du signal et les paramètres IP.  Si vous cliquez sur « DÉCONNECTER », l'écran se déconnecte du Wi-Fi.

### 5.2.3 Bouton d'étage

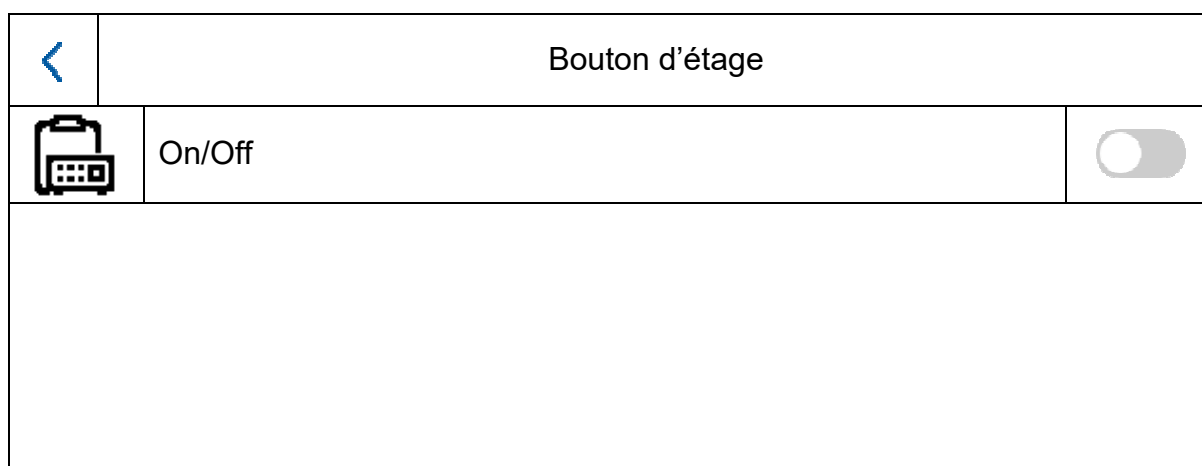







Le bouton d'étage est connecté directement à l'écran via les entrées câblées et effectue une sonnerie directe sur la porte de l'appartement. Cette fonction est utile dans les immeubles d'habitation. Dans ce cas, la platine de rue principale est installée en bas à l'entrée principale. Chaque appartement est toutefois équipé d'un bouton de sonnette sur la porte d'entrée. La sonnerie du bouton d'étage est différente de la sonnerie du module de porte vidéo

Bouton / affichage	Description
Ligne 1 – ligne 8	Indique quelle entrée est utilisée sur l'écran pour le bouton d'étage. En principe, c'est l'entrée 1 (ligne 1) qui est utilisée.
NO / NC	Normally Open / Normally Closed (normalement ouvert/normalement fermé) Ce réglage permet de déterminer si le bouton de sonnette de la porte d'appartement est un contact à ouverture ou à fermeture. En principe il s'agit d'un contact « NO ».

Pour en savoir plus, consultez la section [Consignes d'installation et de mise en service](#) du chapitre « 9.7 Raccordement d'un bouton de sonnette d'étage à l'écran principal ».

## 5.2.4 Autres réglages

### 5.2.4.1 Configuration – Informations locales

	Informations locales				
N° d'appartement			1		
Durée de l'image en temps réel			30 s		
Réglages du service ABUS Link Station			>		
Synchroniser l'heure			>		
Heure d'été			>		
Assistant			>		

Cette zone est protégée par un mot de passe. Veuillez entrer le mot de passe de la configuration initiale.

**Remarque :** Avec le type d'installation « Extension intérieure », les options suivantes sont indisponibles sur l'écran. **Elles sont réglables/consultables uniquement sur l'écran principal du système :**

- Activer/désactiver l'« acceptation automatique » du répondeur.
- Écouter les messages du répondeur
- Application ABUS LINK Station – Menu
- Ajouter des caméras réseau
- Configuration de l'adresse réseau et définition des réglages d'usine sur les périphériques

Type d'installation : Possibilités de sélection : Platine intérieure, extension intérieure

**Platine intérieure :** Écran principal de l'interphone dans un appartement

**Extension intérieure :** il est possible de connecter jusqu'à cinq écrans supplémentaires dans un appartement

Exemple : Module vidéo + platine intérieure + 5 extensions intérieures

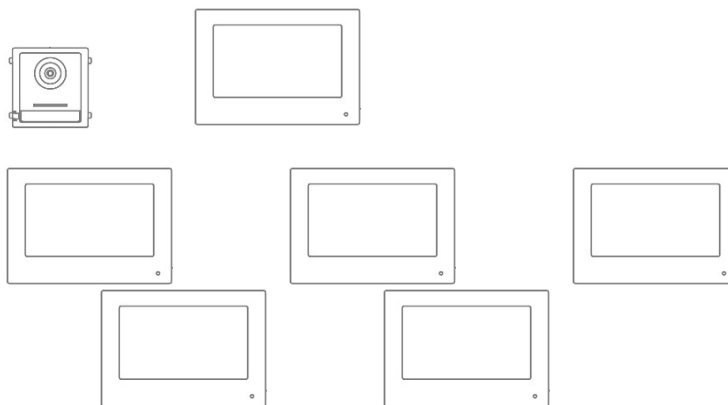

N° d'appartement : Il s'agit du nombre maximum d'écrans de platine intérieure pouvant être connectés à huit extensions de bouton de sonnette à l'aide d'un module vidéo de porte.  
Ce nombre maximum est de 49 écrans de platine intérieure ou 49 appartements.

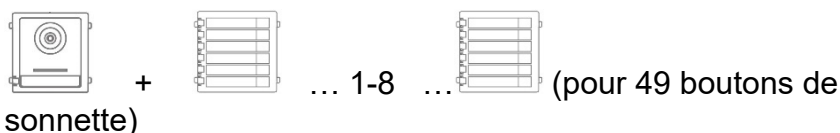

Uniquement avec le réglage « *Extension intérieure* » :

N° (1~5) : Configuration des numéros de l'extension intérieure. Cinq écrans d'extension maximum sont possibles.

Nom de la pièce : Nom de la pièce où se trouve l'écran d'extension.

Durée de l'image en temps réel (10~60s) : Durée d'affichage de l'image en temps réel demandée manuellement d'un module vidéo de porte ou d'une caméra IP raccordée.  
(Consultable sur l'écran d'accueil / l'image en temps réel)

Pour en savoir plus sur la configuration de boutons de sonnette supplémentaires dans un immeuble d'habitation, consultez la section Consignes d'installation et de mise en service du chapitre « 9.3 Configuration de boutons de sonnette supplémentaires (TVHS20020) pour les immeubles d'habitation ».

### **Réglages du service ABUS Link Station :**

La fonction ABUS Link-Station permet de configurer et de connecter facilement une application pour smartphone à l'interphone. Seules quelques étapes sont nécessaires. La platine de rue doit être connectée à Internet.

Ce menu est disponible uniquement sur un écran avec le réglage « Platine intérieure » (écran principal).

Activez cette fonction pour pouvoir accéder à l'application depuis l'interphone.



#### Procédure :

1. Installez l'application ABUS Link Station (lite/pro) (Android/iOS)
2. Dans l'application, cliquez sur « Ajouter un appareil » ou « Scanner le code QR ».
- 3 Scannez le code QR affiché sur la page de réglage du service ABUS Link Station. Chaque







écran de platine intérieure possède son propre code QR.

4. Pendant la configuration, il est nécessaire de saisir le code de vérification. Celui-ci apparaît également dans la page de configuration et peut être modifié à souhait.

Un code QR ne peut-être ajouté qu'à un compte ABUS Link Station. D'autres comptes peuvent accéder à l'interphone après activation.

	Réglages du service ABUS Link Station	
Activer le service ABUS Link Station		
Code de vérification	xxxxxx	
État du serveur ABUS Link Station	Connecté	
		









Synchroniser l'heure : Activer le réglage de l'heure via le protocole NTP.  
 L'intervalle détermine la fréquence d'actualisation en minutes.  
 Le champ de l'adresse IP permet de saisir une adresse de serveur NTP ou une adresse IP.  
 Le numéro de port est réglé sur 123 (port par défaut du protocole NTP).  
 Sélectionnez le fuseau horaire dans lequel se trouve l'interphone (généralement GMT+01:00)

	Synchronisation de l'heure		
 Activer NTP			
Synchroniser l'intervalle	60		
Adresse IP	ntp.org		
N° de port	123		
Fuseau horaire	(GMT+1:00 Amsterdam, Berlin, Rome, Paris)		



	<p>Lors de l'utilisation du service ABUS Link Station en conjonction avec la fonction push pour un appel de sonnerie, la fonction NTP doit être activée et correctement configurée.</p> <p>Assurez-vous d'utiliser l'adresse de serveur NTP correcte "0.pool.ntp.org".</p>
---	--

Heure d'été : Saisie des détails du passage de l'heure d'été à l'heure d'hiver.

	Heure d'été			
	Activer l'heure d'été			
Heure de début	Dernière semaine de mars dimanche 2h00			
Heure de fin	Dernière semaine d'octobre dimanche 3h00			
Décalage	60 min.			
				

Assistant :







Redémarrage de l'assistant d'installation. L'assistant exécute les étapes suivantes :

- a) Réglage de la langue
- b) Réglage du réseau (interface câblée)
- c) Type d'installation ou mode de fonctionnement de l'écran (platine intérieure ou extension intérieure) et numéro d'appartement
- d) Connexion de l'appareil à l'écran.
  - Si platine intérieure -> affectation d'un module vidéo de porte
  - Si extension -> affectation d'un écran principal (platine intérieure)









### 5.2.4.2 Configuration – Réglages du réseau

Ce menu permet de définir les réglages de l'interface réseau câblée

Paramètres réseau		
 DHCP		
IP locale	192.168.0.11	
Masque de sous-réseau	255.255.255.0	
Passerelle	192.168.0.1	
Adresse DNS	192.168.0.1	
Adresse DNS 2	194.25.2.129	

Bouton / affichage	Description
DHCP	Activer/désactiver DHCP. Il est vivement recommandé de régler tous les composants de l'interphone sur une adresse IP fixe.
IP locale	Réglez ici l'adresse IP locale de l'appareil
Masque de sous-réseau	Réglez ici le masque de sous-réseau de l'appareil
Passerelle	Réglez ici la passerelle de l'appareil. Généralement, c'est l'adresse IP du routeur qui est utilisée ici.
Adresse DNS	Réglez ici l'adresse DNS de l'appareil. Généralement, c'est l'adresse IP du routeur qui est utilisée ici.
Adresse DNS 2	Réglez ici l'adresse DNS secondaire de l'appareil. Généralement, c'est l'adresse IP du routeur qui est utilisée ici.

### 5.2.4.3 Configuration – Gestion des appareils

	Gestion des appareils		
Platine de rue principale	192.168.0.26		
			
			
			

La fonction de ce menu diffère entre la platine intérieure et l'extension intérieure. Ici, vous pouvez modifier les affectations des appareils.

#### Attention :

L'écran principal d'un système doit toujours être associé au module vidéo principal.  
L'écran d'extension d'un système doit toujours être associé à l'écran principal du système.







Platine intérieure : - Affectation de la platine de rue principale  
- Ajout de caméras réseau IP supplémentaires pour l'affichage en temps réel. Cliquez pour cela en haut à droite sur le symbole « + » et sélectionnez « Protocole privé » pour une caméra réseau ABUS.

Extension intérieure : - Affectation de la platine intérieure (écran principal)

Dans ce menu, les actions suivantes sont également exécutables :

- Réglage des paramètres réseau (DHCP, adresse IP, etc.) des platines de rue
- Restauration des réglages par défaut des platines de rue

## Réglage des paramètres réseau du module de porte vidéo

Paramètres de la platine de rue	
192.168.0.26	
255.255.255.0	
192.168.0.1	
DHCP	<input type="checkbox"/>
Volume du microphone	 70% 
Volume de la sonnerie	 70% 
Volume d'appel	 70% 
Avorter	OK

**Lignes 1 à 3:**  
**DHCP:**

adresse IP, passerelle et masque de sous-réseau lorsque vous appuyez sur le bouton, la demande des données d'adresse IP du serveur DHCP est lancée. L'interrupteur retourne alors vers la gauche. Les données d'adresse IP reçues sont ensuite définies comme données fixes. Il n'y a pas d'autre interrogation automatique des données.

**Volume du microphone:**

réglage de la sensibilité du microphone dans le module de porte vidéo

**Volume de la sonnerie:**

réglage du volume de la sonnerie après avoir appuyé sur le bouton de sonnerie du module de porte vidéo

**Volume d'appel:**

réglage du volume pendant un appel sur le module de porte vidéo

## Réinitialisation des paramètres d'usine du module de porte vidéo

Tous les paramètres du module de porte vidéo peuvent être réinitialisés ici via le moniteur principal.

Restaurer tous les paramètres par défaut?	
Avorter	OK

## Ajout d'une caméra réseau ABUS

Pour ajouter une caméra réseau ABUS au système, veuillez cliquer sur le symbole « + » en haut à droite sous « Ajouter un appareil ».

Sélectionnez « Protocole privé » pour les caméras ABUS et attribuez un nom. L'adresse IP de la caméra sur le réseau et le port RTSP (par défaut 554) sont requis pour l'intégration. Vous devez enfin saisir le nom d'utilisateur et le mot de passe de votre caméra réseau.









La liste des caméras réseau ABUS compatibles est disponible à l'adresse [www.abus.com](http://www.abus.com).

### 5.2.4.4 Configuration – Réglages par défaut

**Réglages par défaut :** Restaure les réglages par défaut de l'écran. L'activation/le mot de passe est conservé(e).

**Réglages d'usine :** Restaure les réglages d'usine de l'écran, y compris le mot de passe. L'écran se trouve ensuite à l'état « Inactif ».

### 5.2.4 Configuration de relais

<		Configuration de relais		
	Relais 1			
Durée			3 s.	
Intervalle			5 s.	
	Relais 2			

Sous « Configuration de relais », les deux relais de l'écran sont configurés. La configuration dans ce menu n'a aucun impact sur les relais du module de porte vidéo.

Les sorties relais se trouvent à l'arrière de l'écran et peuvent être raccordées à l'aide du faisceau de câbles fourni. L'affectation est imprimée au dos de l'écran.

Le **relais 1** est commuté entre COM1 et NO1, le **relais 2** est exploité sur COM2 et NO2.

Bouton / affichage	Description
Relais 1	Active/désactive la fonction d'une sonnette supplémentaire (ou existante). Le relais 1 sur l'écran se déclenche en même temps qu'un appel.
Durée	Détermine la durée de déclenchement du relais pour la sonnette de porte supplémentaire en cas d'activation de la sonnette.
Intervalle	Détermine l'intervalle pendant lequel le relais déclenche la sonnette de porte supplémentaire pendant la durée définie en cas d'activation de

	la sonnette.
Relais 2	Active/désactive la sortie de commutation supplémentaire sur l'écran (par exemple pour une gâche sur la porte d'appartement à chaque étage). Si la fonction est activée, un autre « symbole de clé » apparaît avec le chiffre « 3 » sur l'écran local.

Pour en savoir plus, veuillez consulter les chapitres « 9.6 Raccordement d'une gâche existante à l'écran de la platine de rue » et « 9.5 Raccordement d'une sonnette existante » dans la section Consignes d'installation et de mise en service.

Vous trouverez ici des informations sur le thème suivant : « 9.8 Raccordement d'une gâche électrique au module vidéo (y compris « porte du jardin ») »

### 5.2.5 Carte microSD

Bouton / affichage	Description
Formater	<b>Attention !</b> La carte microSD est intégralement formatée et toutes les données qu'elle contient sont supprimées.
Désinstaller	Désactive la carte microSD, plus d'enregistrement possible. Vous pouvez retirer la carte microSD en toute sécurité.

### 5.2.6 Verrouillage de l'écran

Verrouille l'écran pendant 30 secondes. Pendant ce délai, l'écran tactile est désactivé, ce qui permet par exemple de le nettoyer.

### 5.2.7 Informations de l'appareil

Vous trouverez ici la version du firmware de l'écran ainsi que le modèle et le numéro de série de votre appareil. Pour en savoir plus sur la mise à jour, consultez le chapitre « Logiciel ABUS CMS : mise à jour du firmware » dans la section Consignes d'installation et de mise en service.

### 5.2.8 Réglage temporel





Ici vous pouvez régler manuellement l'heure/la date de l'écran. Vous pouvez également cliquer directement sur l'heure dans l'écran principal.

### 5.2.9 Redémarrage de l'appareil

Redémarre l'écran.

## 5.2.10 Réglages du mot de passe (CODE PIN)

### Attribution du PIN pour clavier TVHS20030

	Réglages du mot de passe	
Code PIN		
		

Remarque : vous avez besoin du clavier pour la saisie du CODE PIN TVHS20030.

Vous pouvez régler ici un code à six chiffres qui s'appliquera à l'ouverture de la porte à l'aide du clavier. Le code PIN contient toujours six chiffres.

Pour saisir le code PIN sur le clavier, appuyez sur la combinaison de touches suivantes :

Jusqu'au firmware V2.0.8 / V2.1.2 build 200410:

"#" NIP à 6 chiffres "#". Exemple: # 123456 #

Depuis le firmware V2.2.3 / V2.1.2 build 201029:

"#" Numéro d'appartement PIN à 6 chiffres "#". Exemple: # 1123456 #

- c'est-à-dire qu'à partir de ce firmware, le code PIN peut être défini individuellement pour chaque appartement.
- Il est désormais possible de modifier et de supprimer les codes PIN relatifs à l'appartement

Il est possible d'attribuer **un** CODE PIN localement sur l'écran. **Trois** codes supplémentaires peuvent être saisis via la configuration à distance du logiciel ABUS CMS. En tout, 4 codes PIN maximum sont disponibles. Pour ajouter un code via le logiciel ABUS CMS, ouvrez la configuration à distance du module vidéo de porte et sélectionnez l'option de menu « Intercom » et « Permission password ». Les codes PIN sont enregistrés dans le module vidéo et non pas dans le clavier.

## Remote Configuration

The screenshot displays the 'Remote Configuration' interface. On the left is a navigation menu with categories: System (Device Information, General, Time, System Maintenance, User, RS485), Intercom (ID Configuration, Time Parameters), Permission Password (highlighted), and Access and Elevator Control. The main content area is titled 'Configuring the Right and Password Parameters' and contains the 'Permission Password' section. This section includes a 'Password Type' dropdown menu set to 'PublicPassword1', three input fields for 'Old Password', 'New Password', and 'Confirm Password', and a 'Save' button.

### 5.2.11 Langue du système

Sélectionnez la langue souhaitée.

### 5.2.12 Réglage de la luminosité

Vous pouvez régler ici la luminosité de l'écran de 0 à 100 %.

### 5.2.13 Bouton d'étage

Active/désactive la fonction du bouton d'étage. Si la fonction est activée, une option de menu supplémentaire apparaît à droite sous le symbole « Wi-Fi ». La fonction du bouton d'étage est désormais disponible et peut être utilisée via les entrées câblées de l'écran. De plus amples informations sont disponibles sous « 9.7 Raccordement d'un bouton de sonnette d'étage à l'écran principal » dans la section Consignes d'installation et de mise en service.

### 5.2.14 Informations de licence Open Source

Veuillez lire les informations de licence Open Source qui figurent à la fin de ce document.

## 6. Maintenance et nettoyage

### 6.1 *Test de fonctionnement*

Contrôlez régulièrement la sécurité technique du produit ; par exemple l'état du boîtier.

Si vous constatez que le produit ne peut plus être utilisé en toute sécurité, mettez-le hors service et empêchez une remise en service involontaire.

La sécurité d'utilisation du produit n'est plus garantie si

- l'appareil présente des dommages visibles ;
- l'appareil ne fonctionne plus ;
- l'appareil a été stocké longtemps dans des conditions défavorables ;
- l'appareil a été soumis à des contraintes lors du transport.



#### **Remarque :**

Le produit ne nécessite aucune maintenance de votre part. Aucune des pièces contenues dans ce produit ne nécessite de maintenance ou de contrôle de votre part. N'ouvrez jamais le produit.

### 6.2 *Nettoyage*

Nettoyez le produit avec un chiffon propre et sec. En cas d'encrassement plus important, humidifiez légèrement le chiffon avec de l'eau tiède.



Veillez à ce qu'aucun liquide ne pénètre à l'intérieur de l'appareil ; cela pourrait endommager l'appareil. N'utilisez pas de produits nettoyants chimiques ; cela risquerait d'endommager la surface du boîtier.

## 7. Élimination



Les appareils portant ce pictogramme ne doivent pas être éliminés avec les déchets ménagers. Arrivé en fin de vie, le produit doit être éliminé conformément aux dispositions légales en vigueur.

Veillez vous adresser à votre distributeur ou éliminer les produits par le biais de votre point de collecte communal pour les déchets électroniques.

## 8. Avis de licence Open Source

Le produit contient des composants logiciels qui sont concédés sous licence par les titulaires des droits en tant que logiciel libre ou logiciel open source (ci-après dénommé «OSS»). Les licences correspondantes sont jointes au produit sous forme imprimée et / ou sont accessibles via une interface utilisateur graphique. Vous pouvez acquérir des droits d'utilisation dans la mesure où cela est réglementé directement auprès des titulaires de droits. Les licences open source prévalent sur toutes les autres conditions de licence et accords contractuels avec ABUS en ce qui concerne les composants logiciels OSS correspondants contenus dans le produit.

En général, les informations de licence sur les produits ABUS sont disponibles sur [www.abus.com](http://www.abus.com) dans la zone de téléchargement de la description du produit.



## 9. Consignes d'installation et de mise en service

### 9.1 Utilisation du module de sécurité (TVHS10040 / TVHS20340)

Le module de sécurité TVHS10040 (ou nouveau numéro d'article TVHS20340) permet de poser le contact de gâche dans la zone intérieure protégée afin d'éviter les actes de vandalisme. Le module de sécurité est alimenté en tension 12 V et fixé au module vidéo de porte à l'aide du bus RS485.

Veillez utiliser le câble à 4 broches fourni avec le module vidéo de porte. Ce câble doit être débranché d'un côté du connecteur et les câbles connectés au module de sécurité. Les ID des interrupteurs DIP du module de sécurité ne sont pas nécessaires ici et conservent leurs valeurs par défaut. (Interrupteur DIP 1 activé, interrupteurs DIP 2/3/4 désactivés)

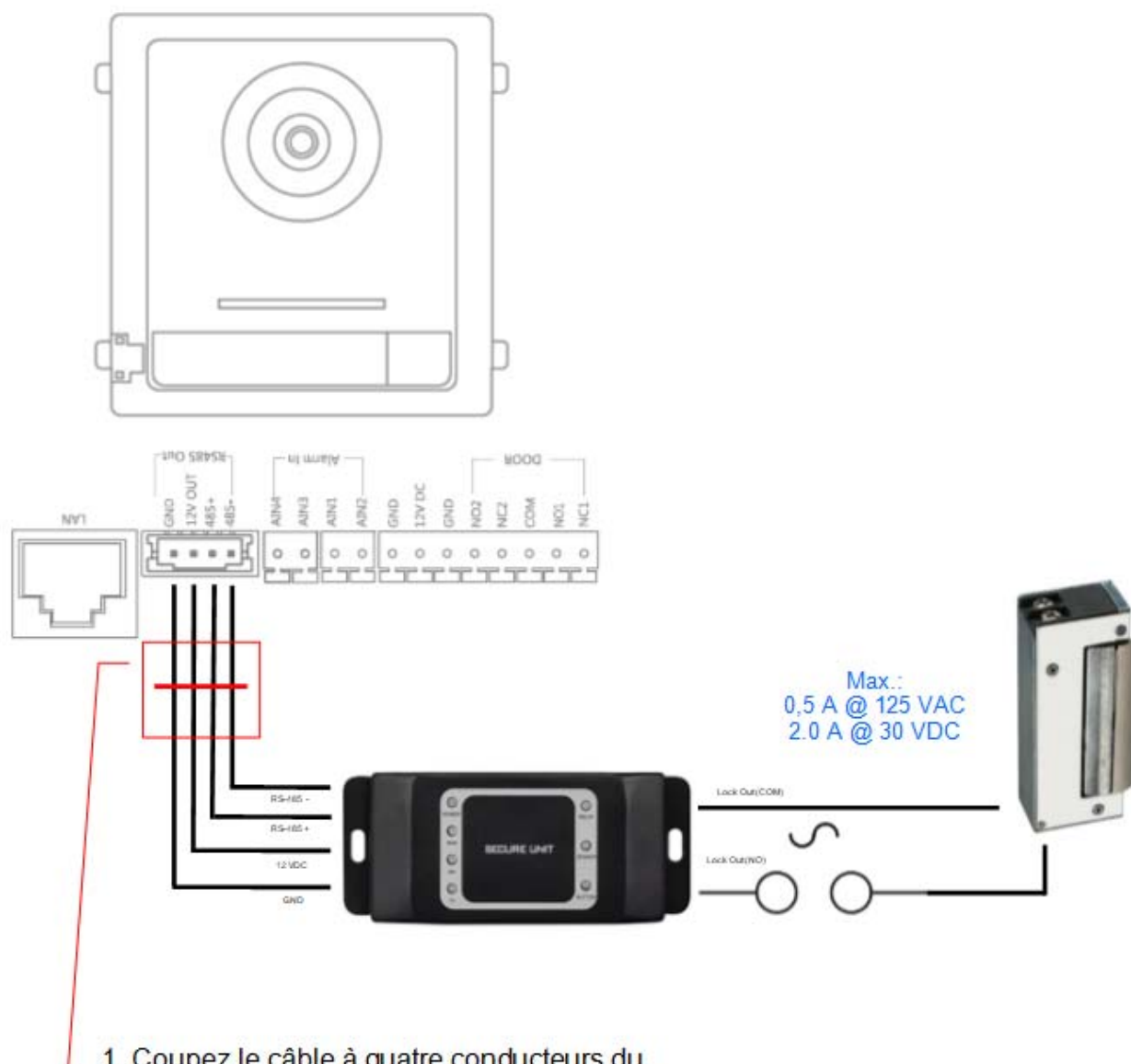

1. Coupez le câble à quatre conducteurs du module de porte vidéo (contenu de la livraison)

2. Connectez les 4 fils de la couleur suivante au module de sécurité.



Jusqu'au firmware V2.0.8 / V2.1.2 build 200410:

Le module de sécurité doit encore être configuré comme nouveau relais de porte. Pour ce faire, ouvrez la configuration à distance du module vidéo de porte avec le logiciel ABUS CMS et allez dans le menu "Intercom" / "IO In Out" et réglez "IO Out" pour "DOOR 1" sur "securityModule"

Depuis le firmware V2.2.3 / V2.1.2 build 201029:

Après avoir connecté le module de sécurité, il est automatiquement reconnu.

Le module de sécurité TVHS10040 doit encore être configuré en tant que nouveau relais de porte. Pour cela, ouvrez la configuration à distance du module vidéo de porte avec le logiciel ABUS CMS et accédez au menu « Intercom » / « IO In Out » puis réglez « IO Out » pour « DOOR 1 » sur « securityModule »

Désormais, à l'ouverture de la porte, ce n'est plus le relais interne du module visiophone qui est activé mais le relais du module de sécurité. Lorsque le relais est actif, la LED verte « Relay » s'allume sur TVHS10040.

**Attention :** un seul module de sécurité TVHS10040 peut être utilisé par module de porte vidéo !

**Remarque :** le module de sécurité est toujours connecté en tant que dernier module. Peu importe qu'il n'y ait qu'un module de porte vidéo ou des modules d'extension supplémentaires.

Capacité de charge du relais : max. 2 A 30 VDC / 0,5 A 125 AC

## 9.2 Configuration des entrées secondaires

Pour intégrer un autre module vidéo de porte (neuf maximum) dans le système afin de créer une entrée secondaire (par ex. : réception des marchandises, porte de cave, etc.), veuillez procéder comme suit :

- 1) Connectez le module vidéo de porte de l'entrée secondaire au réseau de l'interphone principal. Tous les appareils de l'interphone doivent faire partie du réseau local physique.
- 2) Ouvrez le logiciel ABUS CMS et activez le module de porte de l'entrée secondaire.

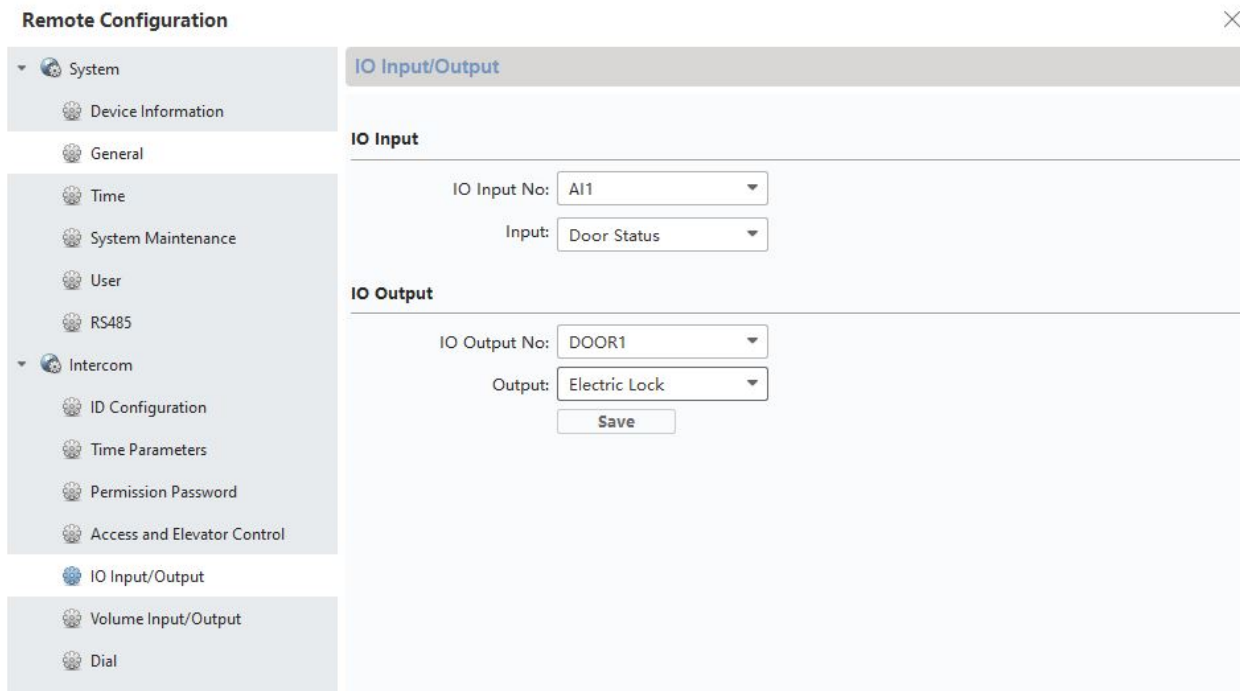

3) Ajoutez le module interphone de l'entrée secondaire au logiciel ABUS CMS, puis ouvrez la configuration à distance.

4) Sous « Intercom », basculez maintenant vers « Room Number ». Entrez le numéro de l'entrée secondaire sous « No.: ». Le module vidéo de porte principal doit avoir le numéro « 0 ». Les entrées secondaires supplémentaires sont numérotées de 1 à 9. Ne modifiez pas les numéros « Period/Building/Unit ou Floor ».

Le système redémarre après l'enregistrement. Veuillez confirmer avec « OK ».

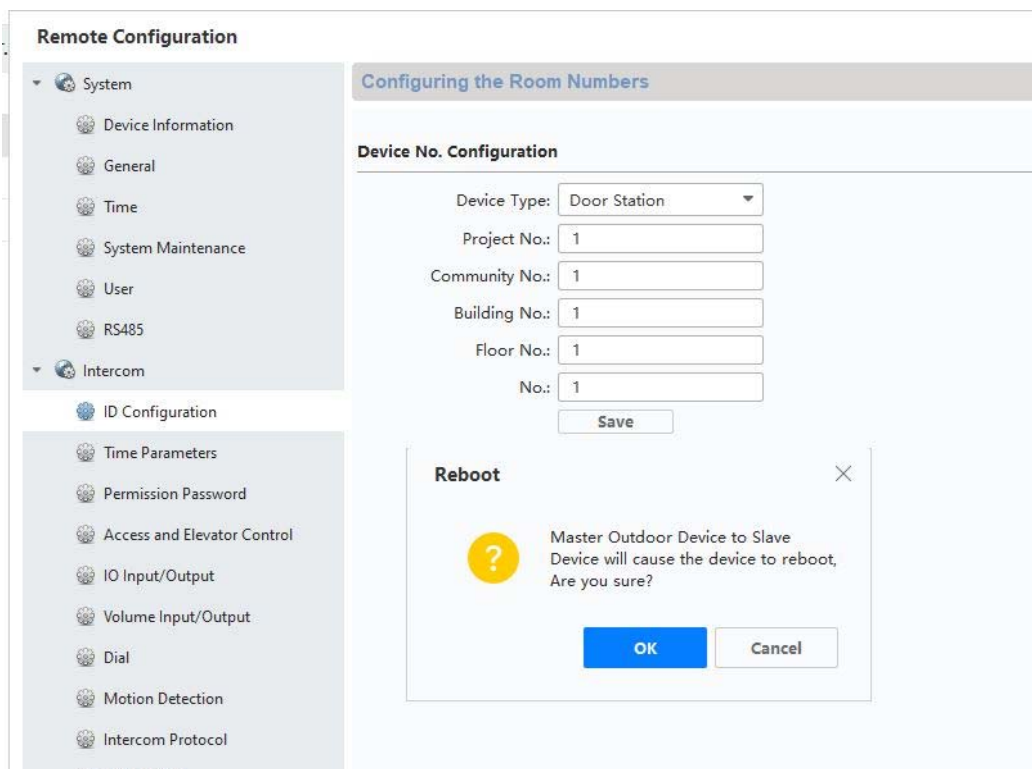

- 5) Après le redémarrage, il est nécessaire d'affecter la porte principale à l'entrée secondaire. Sous « *Network* » / « *NetConfig SIP* » puis « *(Main)Outdoor IP Address* », entrez l'adresse IP de la platine de rue principale puis enregistrez.

**Attention :** Le menu « *(Main) Outdoor IP Address* » apparaît uniquement si vous avez correctement effectué l'étape 4).

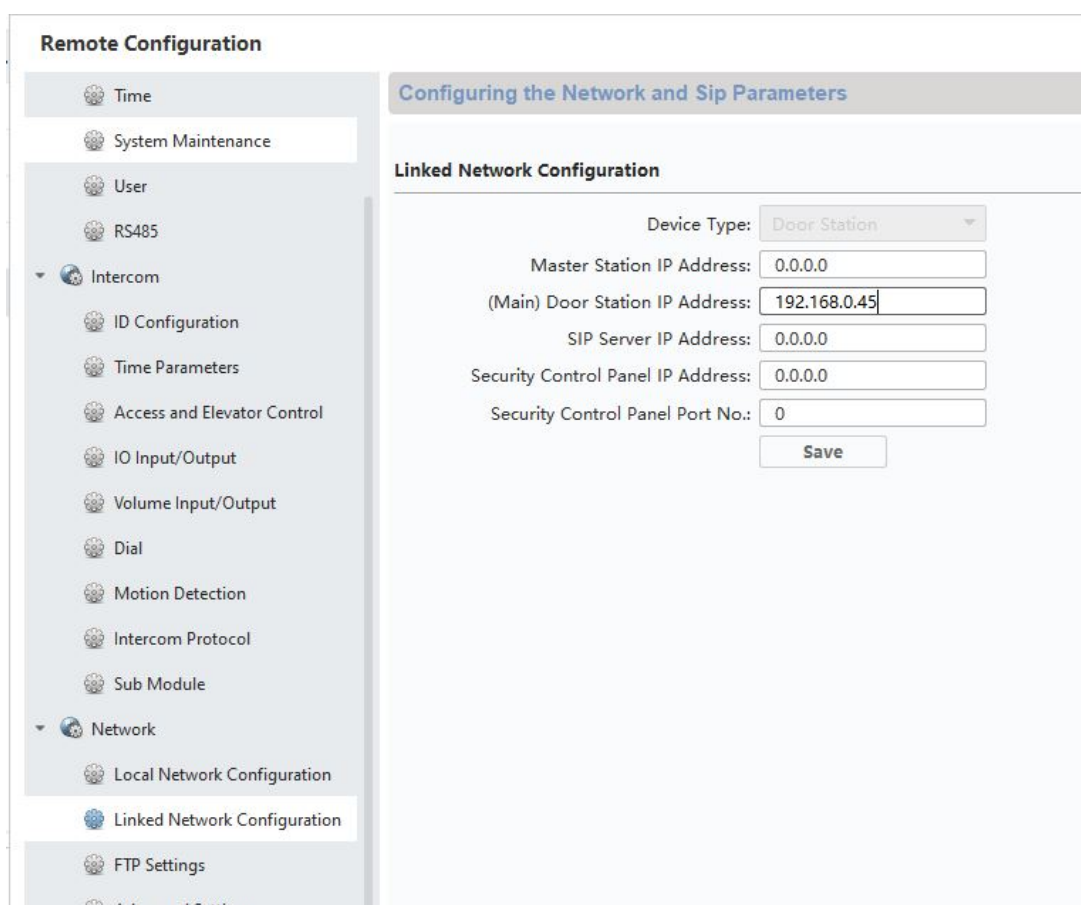

The screenshot displays the 'Remote Configuration' web interface. On the left is a navigation menu with categories like 'Time', 'System Maintenance', 'User', 'RS485', 'Intercom', and 'Network'. The 'Network' category is expanded, showing 'Local Network Configuration', 'Linked Network Configuration', 'FTP Settings', and 'Advanced Settings'. The main content area is titled 'Configuring the Network and Sip Parameters' and contains a 'Linked Network Configuration' section. This section includes a 'Device Type' dropdown menu set to 'Door Station', and several IP address fields: 'Master Station IP Address' (0.0.0.0), '(Main) Door Station IP Address' (192.168.0.45), 'SIP Server IP Address' (0.0.0.0), and 'Security Control Panel IP Address' (0.0.0.0). A 'Security Control Panel Port No.' field is set to '0'. A 'Save' button is located at the bottom right of the configuration area.

- 6) La configuration d'une entrée secondaire est maintenant terminée. Si la sonnette est activée à l'entrée secondaire, l'écran affiche également que l'appel a été initié à partir d'une entrée secondaire. Sous « *LIVEBILD* » sur l'écran, vous pouvez maintenant accéder directement à l'image vidéo de l'entrée secondaire et ouvrir la porte.

### 9.3 Configuration de boutons de sonnette supplémentaires (TVHS20020) pour les immeubles d'habitation

Les modules supplémentaires (TVHS20020) permettent de créer jusqu'à 49 boutons de sonnette pour les immeubles d'habitation. Le module d'extension se raccorde au module vidéo principal à l'aide du câble de raccordement.

Si un seul module de bouton de sonnette supplémentaire est utilisé, l'installation peut s'effectuer sans le logiciel ABUS CMS.

Le module de porte principal est la sonnette portant le « Numéro d'appartement 1 ». Le module d'extension TVHS20020 est automatiquement réglé sur le numéro d'appartement 2 à 7. « Apartment » correspond toujours à un appartement autonome.

Si vous n'utilisez pas le bouton de sonnette du module vidéo principal et le fermez à l'aide d'une plaque de recouvrement, vous devez configurer le module d'extension TVHS20020 via le logiciel ABUS CMS. Sous « Intercom » / « Sub module » figurent tous les modules d'extension raccordés au bus RS-485. (Exception : le module de sécurité TVHS10040 n'apparaît pas ici)

Dans le menu « *Submode* », veuillez cliquer sur le symbole « Settings » pour procéder à l'affectation des numéros d'appartement.

L'ID du sous-module dépend de l'ID défini avec les interrupteurs DIP à l'arrière du boîtier des modules d'extension. Ceci facilite l'affectation en cas de configuration comprenant plusieurs modules d'extension.

**Attention :** après avoir modifié les ID avec les interrupteurs DIP, il est nécessaire de débrancher brièvement chaque module d'extension du câble puis de redémarrer.

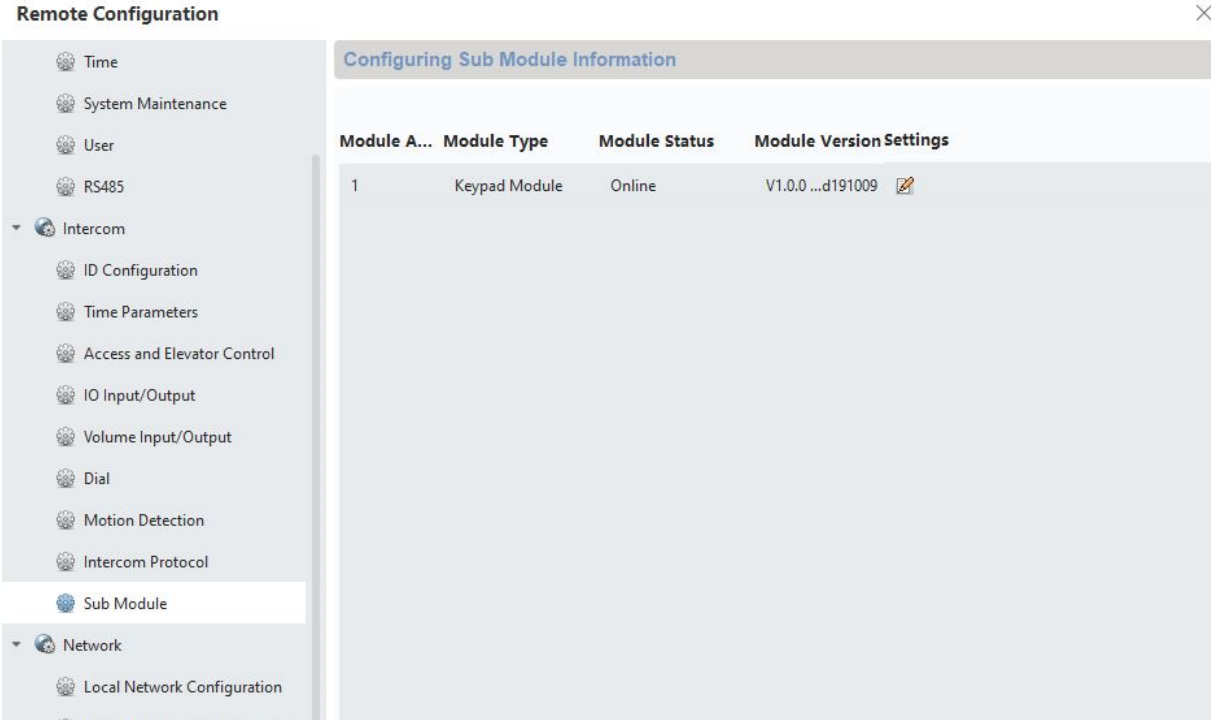

The screenshot shows a web-based configuration interface titled "Remote Configuration". On the left is a navigation menu with categories: Time, System Maintenance, User, RS485, Intercom, and Network. The "Intercom" category is expanded, showing options like ID Configuration, Time Parameters, Access and Elevator Control, IO Input/Output, Volume Input/Output, Dial, Motion Detection, Intercom Protocol, and Sub Module. The "Sub Module" option is selected. The main content area is titled "Configuring Sub Module Information" and contains a table with the following data:

Module A...	Module Type	Module Status	Module Version Settings
1	Keypad Module	Online	V1.0.0 ...d191009 

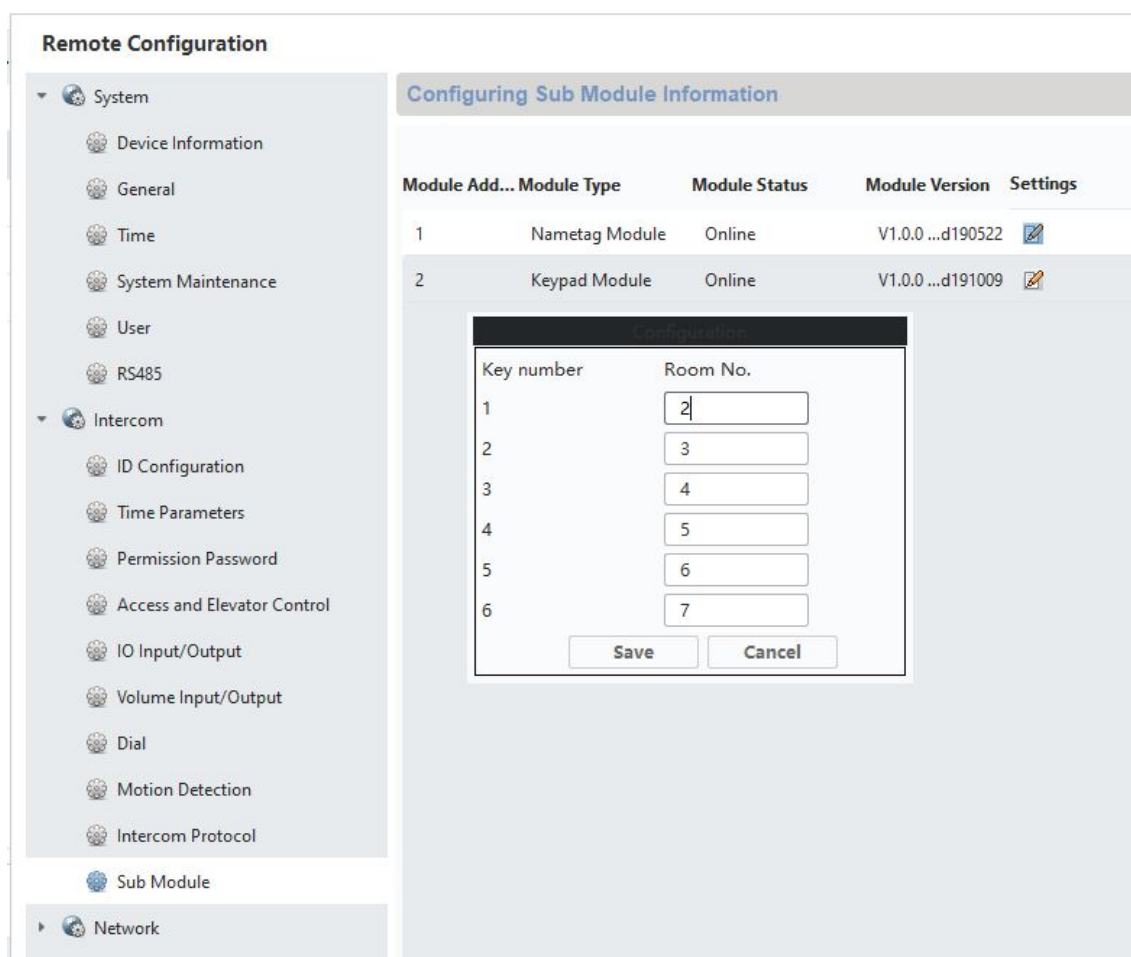

Configuration du numéro d'appartement sur l'écran :

Pour que les boutons de sonnette des appartements soient affectés aux écrans correspondants, les numéros d'appartement des écrans doivent concorder avec les numéros des boutons de sonnette.

Le numéro d'appartement de l'écran correspondant s'affiche dans la vue principale de l'écran. Vous pouvez modifier les numéros directement dans la configuration sur l'écran (configuration/numéro d'appartement) ou accéder à l'écran correspondant à l'aide du logiciel ABUS CMS et dans le menu « *Intercom* »/ »*Room Number* », modifier le numéro d'appartement sous « *room.No.:* ».

### Exemple de couvercle du bouton de sonnerie sur le module de porte vidéo

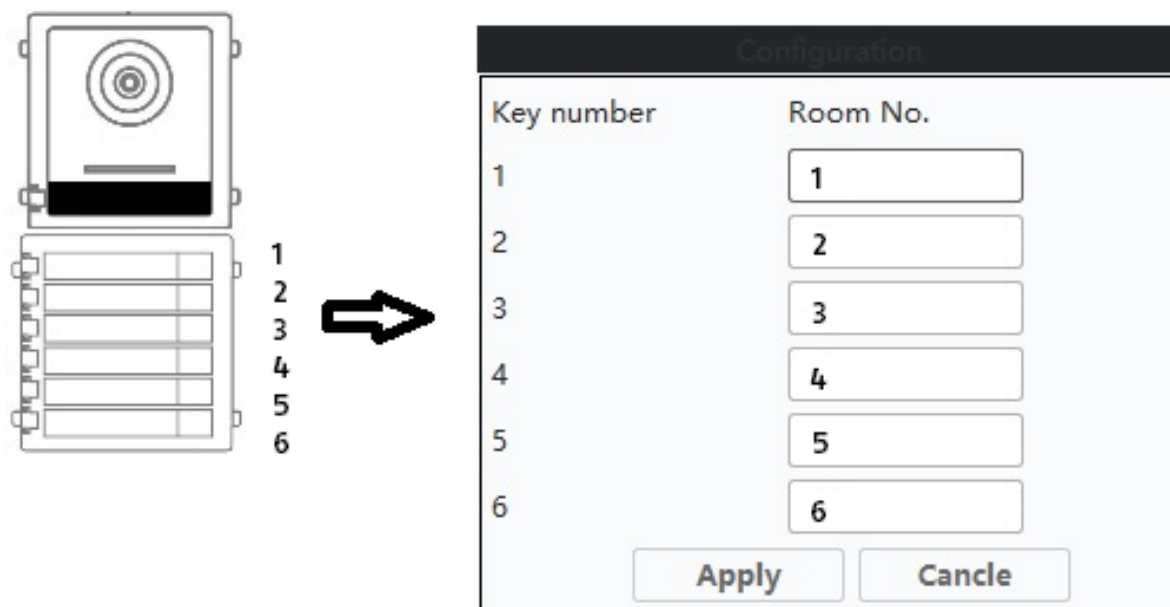

#### **9.4 Réglage du volume sur le module vidéo de porte (TVHS20000, TVHS20010)**

Le logiciel ABUS CMS permet de régler la sensibilité du microphone et le volume de la voix sur le module vidéo de porte. En outre, vous pouvez régler le volume des tonalités de confirmation / des tonalités d'appel / du signal occupé ou le couper.

<b>Bouton / affichage</b>	<b>Description</b>
Volume In	Règle la sensibilité du microphone du module vidéo de porte. Plus la valeur est élevée, plus la voix transférée vers l'écran est forte.
Volume Out	Régule la sortie vocale automatique (par ex. : laisser un message, échec de l'appel, etc. Le volume des tonalités de confirmation / tonalités d'appel et du signal occupé peut également être réglé à l'aide de cette commande. (0 correspond à silencieux)
Talk Volume	Ce paramètre permet de régler le volume de la voix. Plus la valeur est élevée, plus la voix transférée de l'écran vers la platine de rue est forte.

## Remote Configuration

The screenshot displays the 'Remote Configuration' interface. On the left is a navigation menu with categories: 'System' (Device Information, General, Time, System Maintenance, User, RS485) and 'Intercom' (ID Configuration, Time Parameters, Permission Password, Access and Elevator Control, IO Input/Output, Volume Input/Output, Dial, Motion Detection, Intercom Protocol). The 'Volume Input/Output' option is highlighted. The main panel is titled 'Configuring the Volume Input or Output' and contains three sliders: 'Volume Input' (set to 7), 'Volume Output' (set to 7), and 'Talk Volume' (set to 7). A 'Save' button is located at the bottom right of the main panel.

### 9.5 Raccordement d'une sonnette existante

Si vous possédez déjà une sonnette/un carillon, il est possible de la/le raccorder à la sortie relais 1 (COM / NO I) de l'écran. Le relais peut être soumis à une charge maximale de 2 A @ 30 VDC ou 0,5 A @ 125 AC.

En cas d'activation de la sonnette, le relais s'active selon l'intervalle souhaité et pendant la durée définie. La configuration du « Relais 1 » est accessible dans le menu de l'écran sous « Configuration de relais ».

Comme la sonnerie locale sur l'écran, le relais s'active conformément à la valeur définie sous « Durée de la sonnerie » dans le menu « Réglages d'appel ».

Pour n'entendre que la sonnerie de votre carillon externe, vous pouvez activer ou désactiver la sonnerie sur l'écran dans les « Réglages d'appel » dans le menu « Activer la sonnerie ».



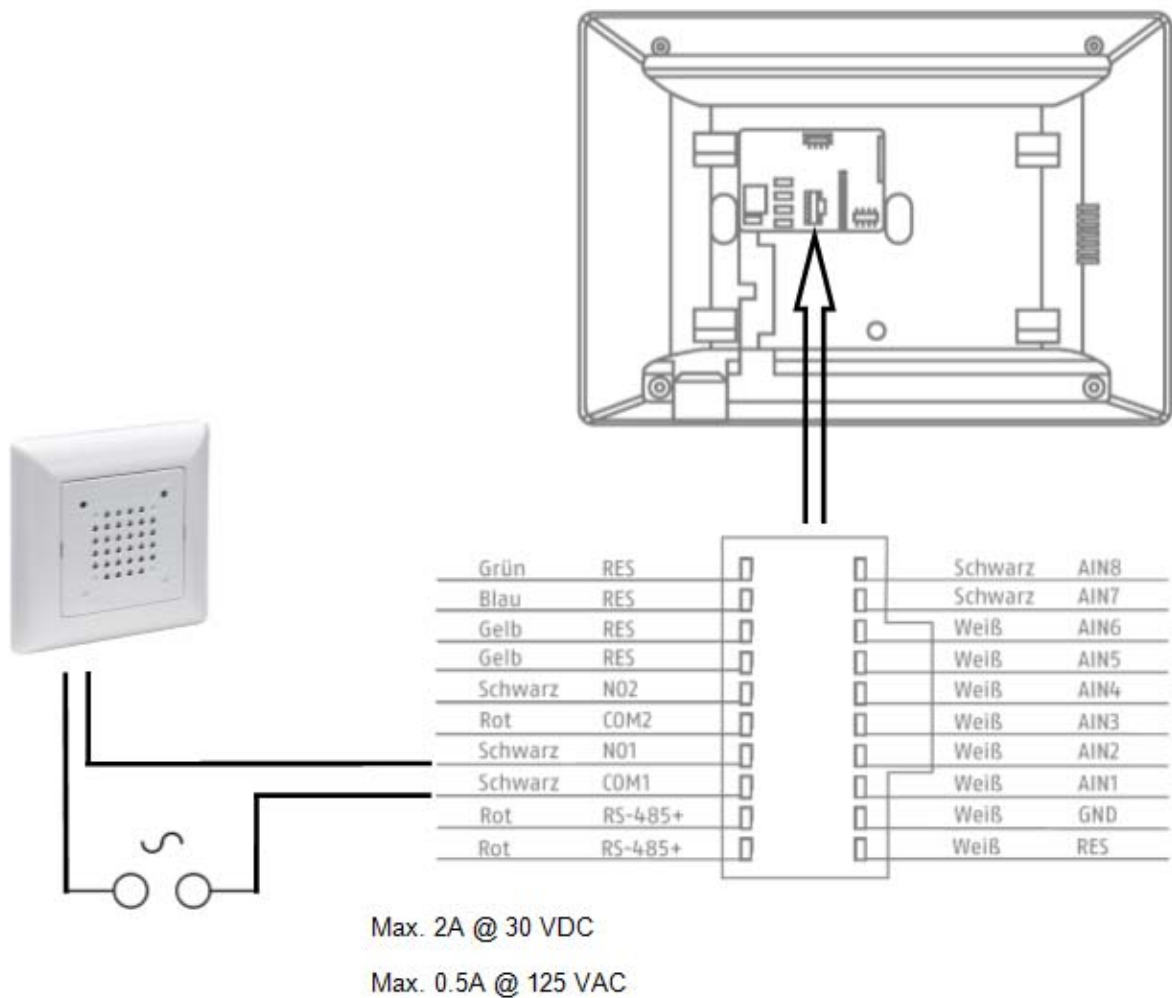

### 9.6 Raccordement d'une gâche existante à l'écran de la platine de rue

Pour ouvrir une porte d'appartement séparément de la porte d'entrée principale, l'écran permet d'activer une porte supplémentaire à l'aide d'une sortie relais (relais 2). Le relais peut être soumis à une charge maximale de 2 A 30 VDC / 0,5 A 125 AC.

Pour utiliser le relais sur l'écran, activez au préalable le « Relais 2 » dans le menu de l'écran sous « Configuration de relais ». L'écran affiche maintenant un symbole de clé supplémentaire avec l'identifiant « 3 ». Les identifiants « 1 » et « 2 » sont réservés aux relais du module vidéo de porte.

Le relais « 3 » de l'écran ne peut être activé directement que sur l'écran et non pas avec l'application ABUS LINK STATION.

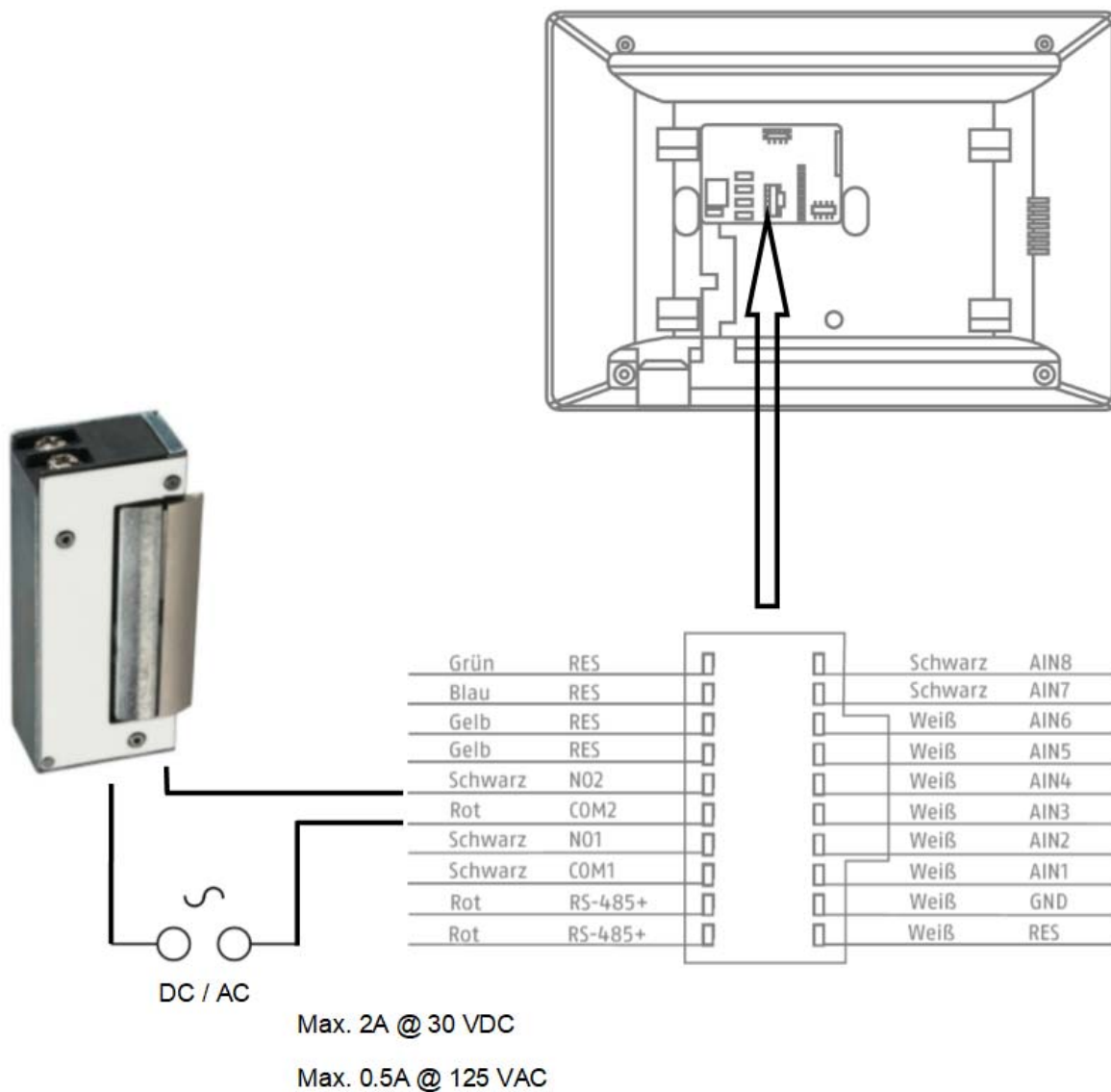

### 9.7 Raccordement d'un bouton de sonnette d'étage à l'écran principal

Le bouton d'étage (bouton de sonnette directement sur la porte d'appartement d'un immeuble d'habitation) peut être raccordé directement à l'écran. Directement câblé à l'entrée d'alarme 1, l'écran peut émettre un signal de sonnerie et indiquer au client que la sonnette a retenti à la porte de l'appartement du haut.

**Remarque :** il est impossible de modifier la sonnerie du bouton d'étage. Elle est différente de la sonnerie activée à partir du module vidéo de porte, ce qui permet de savoir quelle sonnette a été activée. Le bouton d'étage ne déclenche aucune interaction sur l'écran. Seule une brève sonnerie retentit.

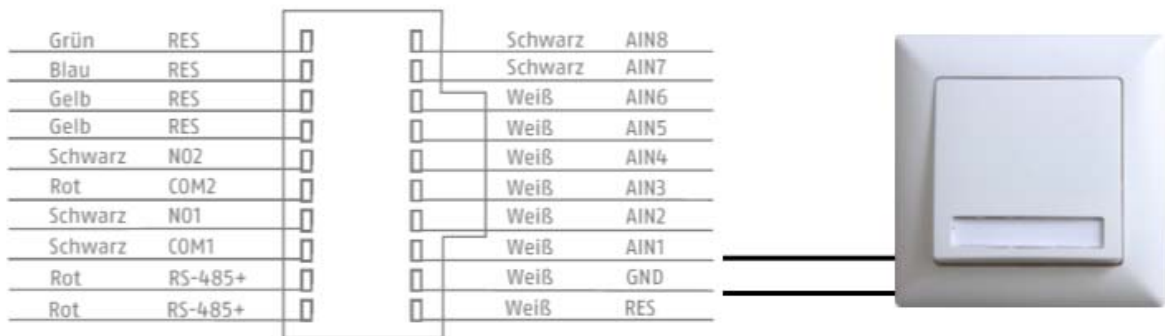
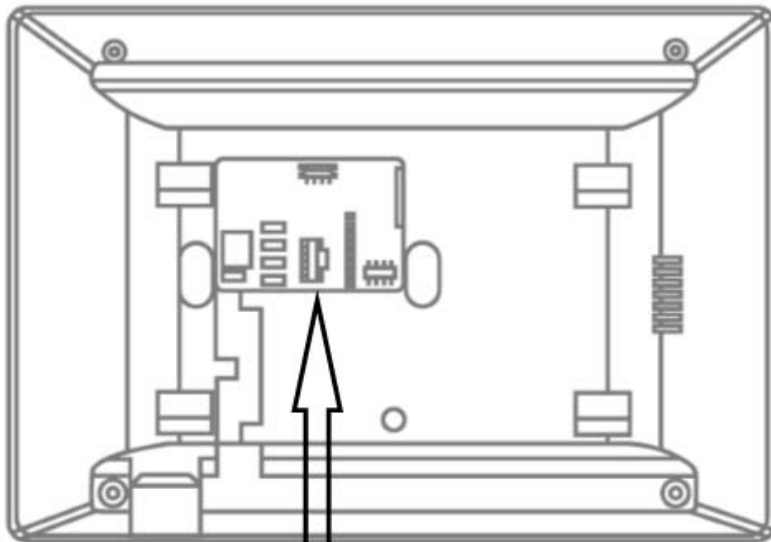

### 9.8 Raccordement d'une gâche électrique au module vidéo (y compris « porte du jardin »)

Deux relais indépendants peuvent être activés sur le module vidéo de porte, par exemple pour ouvrir les portes. Pour configurer les relais, ouvrez la configuration à distance du module vidéo de porte dans le logiciel ABUS CMS et basculez vers le menu « Intercom » / « IO in out ».

Sous « IO out », vous pouvez configurer les relais correspondants pour DOOR 1 et DOOR 2, ou les désactiver. Lorsque le relais est désactivé, le symbole de la clé de l'ouverture de porte ne s'affiche ni dans l'application ABUS Link Station, ni directement sur l'écran.

Remarque : seul l'un des deux relais peut être réglé sur « securityModule » (module de sécurité TVHS10040).

Bouton / affichage	Description
Disable	Le relais n'est pas utilisé et est masqué
electricLock	Le relais interne du module vidéo de porte est utilisé
securityModule	Le module de sécurité externe TVHS10040 est utilisé. (Voir l'option de menu « Module de sécurité »)

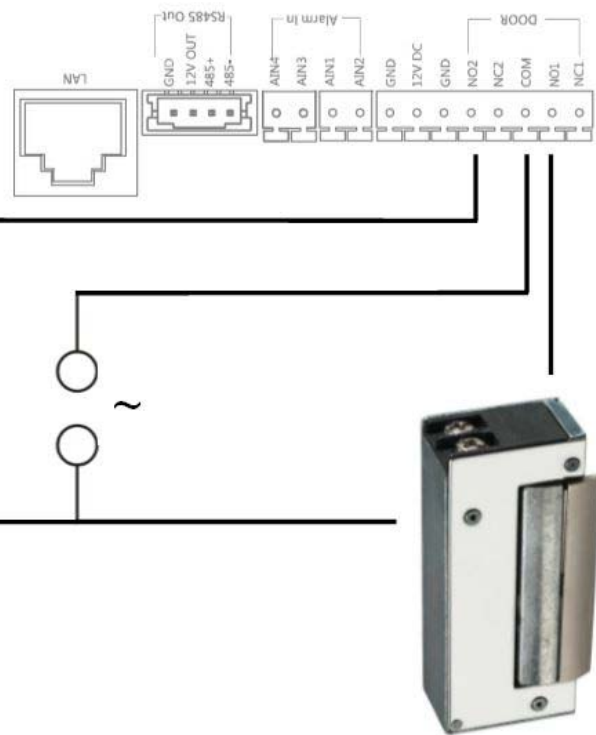
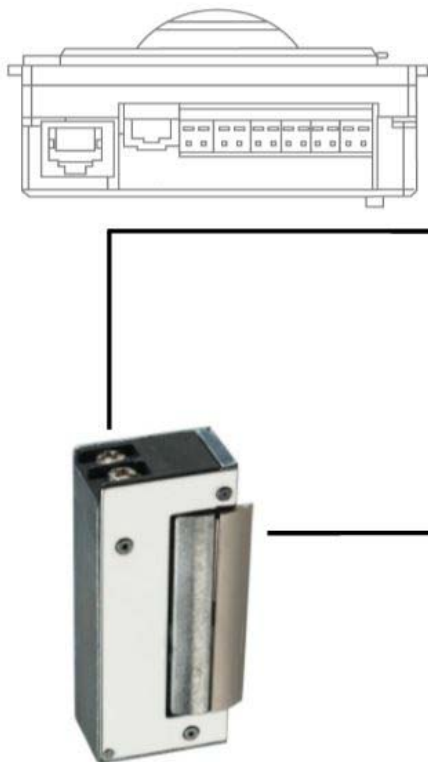
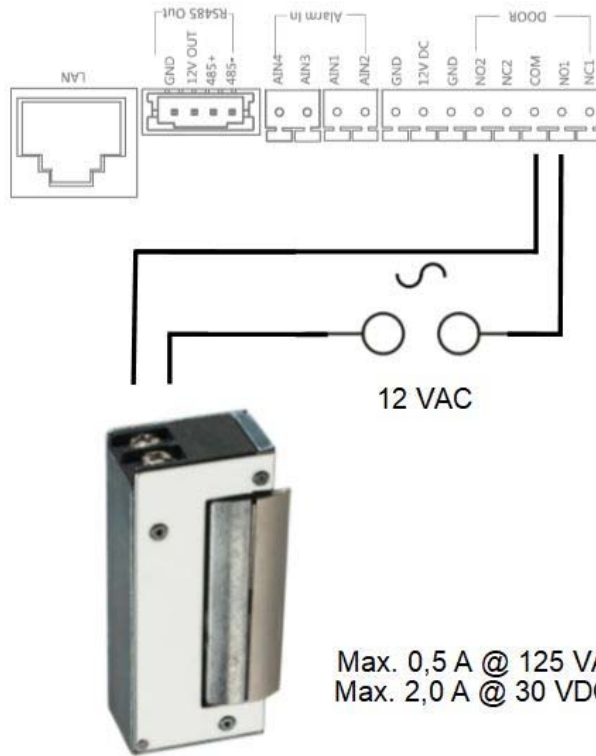
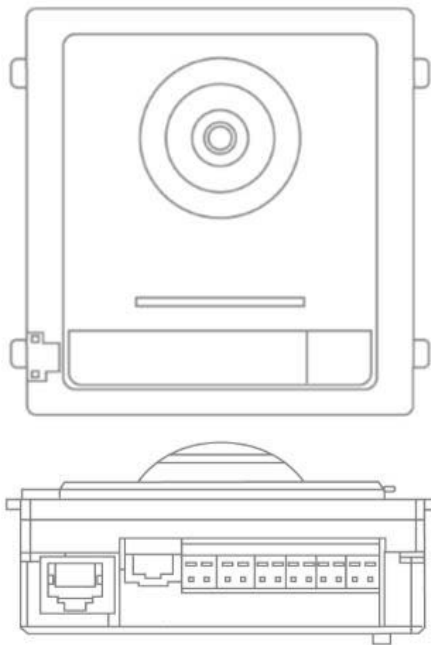

Max. 0,5 A @ 125 VA  
Max. 2,0 A @ 30 VDC

Max. 0,5 A @ 125 VA  
Max. 2,0 A @ 30 VDC

## 9.9 Importation de vos propres sonneries dans l'écran de la platine de rue

Vous pouvez faire retentir vos sonneries au format \*wav sur votre écran via le logiciel ABUS CMS. Pour cela, ouvrez la configuration à distance de l'écran correspondant et basculez vers « Intercom » dans le menu « Ring import ». Sélectionnez un emplacement libre puis chargez le fichier audio \*WAV. Une fois le chargement terminé, le fichier est disponible directement sur l'écran sous « Sonneries ».

**Attention :** une sonnerie sélectionnée dans l'écran ne peut être supprimée avec ABUS CMS. Sélectionnez d'abord une autre sonnerie dans l'écran, puis réessayez de supprimer la sonnerie dans CMS.

Veillez noter impérativement les paramètres suivants du fichier WAV :

Format: wav;

Taille maximale: ≥300 Ko;

Débit binaire: 8 KHz;

Canal : Mono

Débit binaire : 128 Kbps

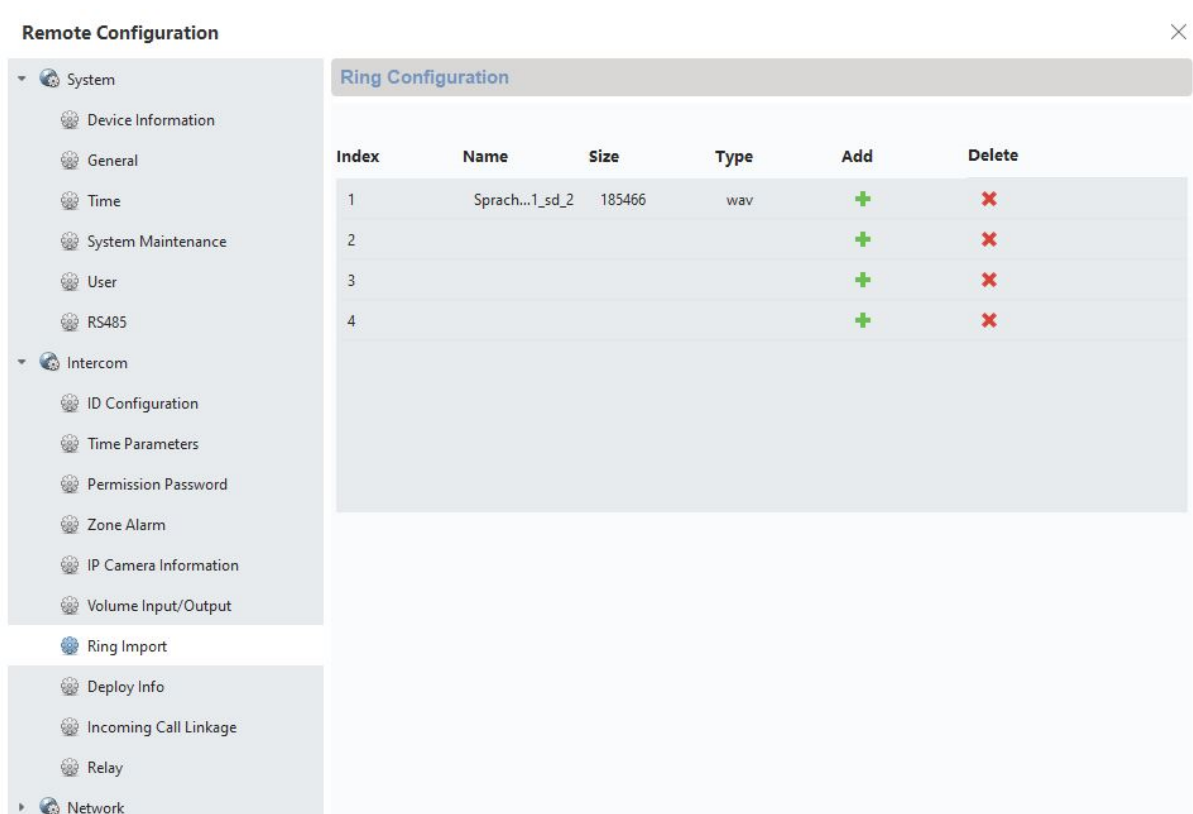

The screenshot displays the 'Remote Configuration' window with a sidebar menu on the left and a main content area on the right. The sidebar menu includes categories like 'System', 'Intercom', and 'Network'. The 'Intercom' category is expanded, showing options such as 'Ring Import'. The main content area is titled 'Ring Configuration' and contains a table with the following data:

Index	Name	Size	Type	Add	Delete
1	Sprach...1_sd_2	185466	wav	+	×
2				+	×
3				+	×
4				+	×

## 9.10 ABUS CMS : mise à jour du firmware des composants Moduvis

**Attention :** ne débranchez jamais l'alimentation électrique ni le câble réseau pendant une mise à jour

**Attention :** effectuez la mise à jour uniquement dans un environnement réseau (réseau local) stable.

Il est recommandé de restaurer les réglages d'usine de chaque appareil après une mise à jour du firmware.

Le logiciel ABUS CMS est nécessaire pour installer une mise à jour du firmware sur un écran ou le module de porte vidéo. Connectez les appareils au réseau et ouvrez la configuration à distance de chaque appareil.

Accédez à « Maintenance » / « System Maintenance » et sélectionnez le fichier qui correspond à l'appareil.

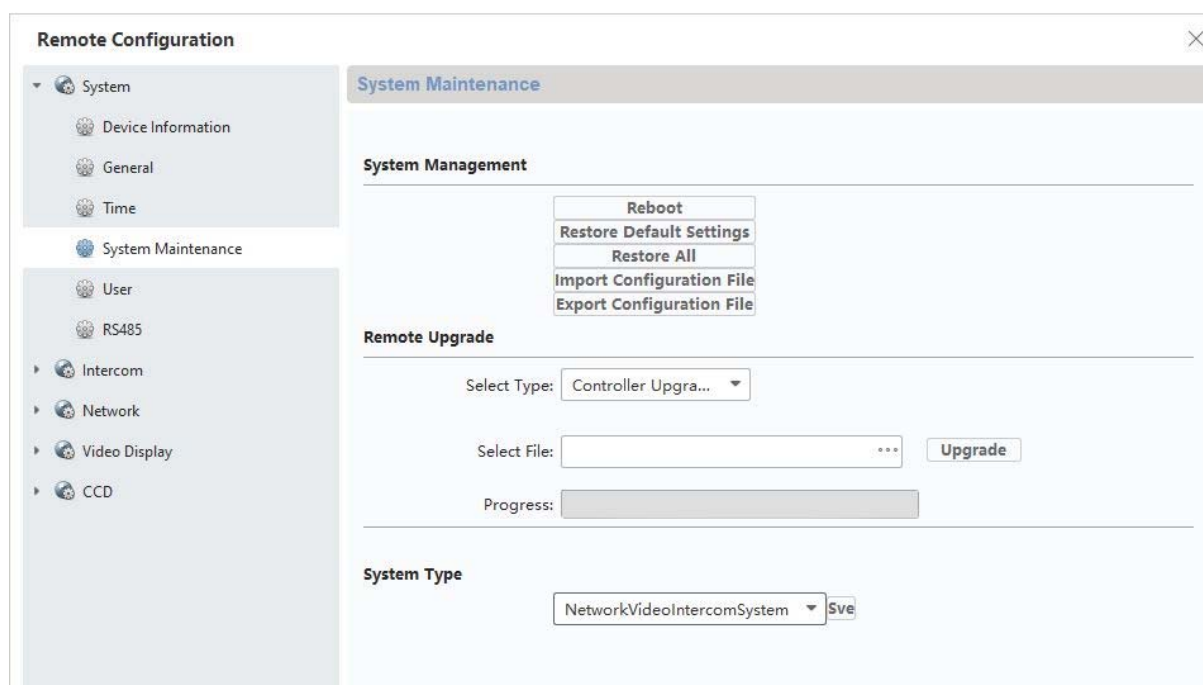

En cas de mise à jour d'un module vidéo de porte (TVHS20000, TVHS20010), sélectionnez « Controller Upgrade ».

La version actuelle du firmware peut être déterminée à l'aide du programme d'installation ABUS IP ou dans le logiciel CMS dans la configuration de l'appareil correspondante sous « Device Information ».

**Remote Configuration** ×

System

- Device Information
- General
- Time
- System Maintenance
- User
- RS485
- Intercom
- Network
- Video Display
- CCD

**Displaying the Device Information**

**Basic Information**

Device Type: TVHS20000

Device Serial No.: TVHS200000120200110RRP11705670

**Version Information**

Version: V2.2.3 build 201029

Hardware Version: 0x0



Après une mise à jour du firmware, les étapes suivantes doivent être effectuées:

1. Redémarrez l'ensemble du système en supprimant la tension d'alimentation
2. Réinitialisez tous les appareils mis à jour aux paramètres d'usine ("Tout restaurer")

## 9.11 ABUS CMS : réglages avancés

Vous trouverez ci-dessous un bref aperçu des réglages possibles via la configuration à distance avec le logiciel ABUS CMS.

Chaque écran et module vidéo de porte apparaît comme un périphérique réseau autonome dans le réseau. Peu importe que l'appareil soit connecté par la technologie 2 fils ou PoE.

Réglages à distance de **TVHS20000**, **TVHS20010**, module de porte vidéo :

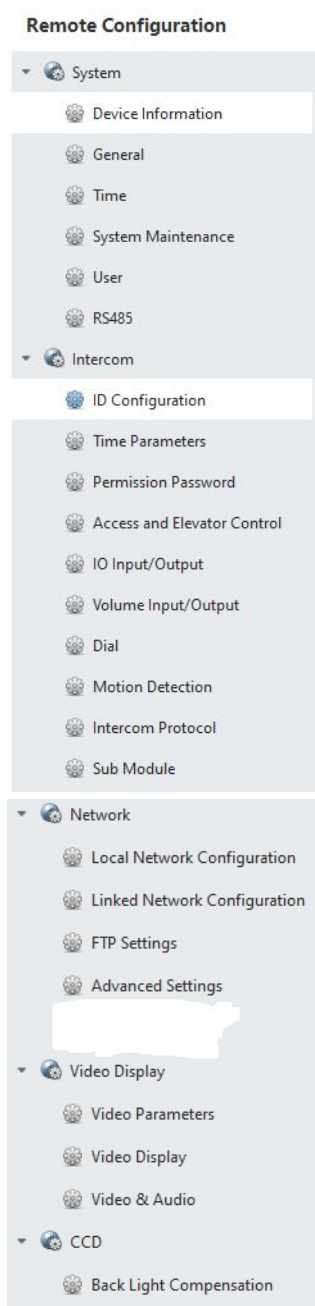

	Section « System »
Device Information	Informations générales sur le firmware, numéro de série
General	Nom de l'appareil et ID de l'appareil (pas importants pour l'interphone)
Time	Réglage de la date et de l'heure, heure d'été et serveur NTP
Maintenance	Menu de maintenance pour la mise à jour du firmware, restauration des réglages d'usine et redémarrage de l'appareil
User	Le menu n'est pas utilisé
RS485	Le menu n'est pas utilisé
	Section « Intercom »
ID Configuration	« Device Type » doit toujours être réglé sur « Outdoor unit ». Veuillez ne pas modifier les valeurs numériques des unités « Period, Building, Unit, Floor » car ces valeurs ne sont pas requises ici. Les entrées secondaires sont configurées sous « No. : ». 0 = porte principale, « 1 » – « 9 » = entrées secondaires. Veuillez lire le chapitre « Configuration des entrées secondaires ». (Voir les <u>consignes d'installation et de mise en service</u> )
Time Parameters	<b>Max talk time</b> : durée maximale d'un appel accepté. (90-120 secondes) <b>Max Msg time</b> : durée d'enregistrement du répondeur (30-60 secondes)
Permission Password	Il est possible de définir ici trois codes PIN supplémentaires (6 chiffres) pour une utilisation avec TVHS20030.
Access and elevator control	<b>Door. No.</b> : choix entre sortie de relais 1 ou 2. <b>Open door time</b> : détermine la durée d'activation de la gâche par le relais. (1-255 sec.)  « <b>Door name</b> » et « <b>Card encrypt</b> » ne sont pas utilisés.



IO Input Output	Réglages des entrées numériques (pour gâche d'urgence) et des relais de gâche.
Volume Input Output	Réglages des paramètres audio du module de porte vidéo. (Voir les <u>consignes d'installation et de mise en service</u> )
Dial	Définit l'affectation d'appartement pour le bouton de sonnerie sur le module vidéo de porte même. Par défaut, « room No. » est réglé sur « 1 ». L'écran portant le numéro d'appartement 1 est donc appelé.
Ring Import	Les sonneries ne peuvent être réglées que dans la configuration à distance de l'écran. Le module de porte vidéo même n'a pas de sonneries.
Motion detection	Réglage de la détection de mouvement en lien avec ABUS NVR (Veuillez installer et configurer la détection de mouvement directement via ABUS NVR)
Intercom Protocol	Inutilisé
Sub Module	Vue d'ensemble des modules d'extension raccordés, par ex. : TVHS20020, TVHS20030, TVHS20040
	<b>Section « Network »</b>
Local NetCfg	Adresse IP du module de porte vidéo. <b>(Adresse IP, masque de sous-réseau, passerelle standard)</b>  <b>Port : 8000</b> est nécessaire pour l'intégration dans un ABUS NVR  <b>Port http</b> est inutile car aucune interface Web n'est présente
Linked network configuration	L'option de menu n'est pas utilisée pour un module de porte vidéo principal.  <b>Main Outdoor IP Address</b> : Utilisé lors de l'affectation de la platine de rue principale à une entrée secondaire. (Voir les <u>consignes d'installation et de mise en service</u> )
FTP Configuration	Inutilisé
Advanced settings	Configuration de l'adresse du serveur DNS du module vidéo de porte
	<b>Section « Display »</b>
Video parameters	Réglage des paramètres d'image (luminosité, contraste, saturation)
Video Display	Réglage de l'affichage OSD (nom de la caméra, date, heure, position du texte)
Video&Audio	Réglage des paramètres de flux de la caméra du module de porte vidéo.

	<b>Attention</b> : Il n'est pas recommandé de modifier les paramètres.
Back Light compensation	Options de réglage de la fonction BLC pour compenser le contre-jour.

Configuration à distance « Monitor **TVHS20200**, **TVHS20210** » :



Device Information	Informations telles que « Firmware », « Numéro de série », etc.
General	Nom de l'appareil et ID de l'appareil (pas importants pour l'interphone)
Time	Réglage de la date et de l'heure, heure d'été et serveur NTP
Maintenance	Menu de maintenance pour la mise à jour du firmware, restauration des réglages d'usine et redémarrage de l'appareil
User	Inutilisé
RS485	Inutilisé
	<b>Section « Intercom »</b>
ID configuration	Sélection du numéro d'appartement (numéro d'appartement) en mode « Indoor Station » (écran principal) En mode « Station Extension » (écran d'extension), le numéro de l'écran d'extension est configuré.  Remarque : La sélection du mode « Écran principal » ou « Écran d'extension » et l'attribution des numéros s'effectuent généralement via le menu de chaque écran. (Par ex. : dans le processus de configuration à l'aide de l'assistant d'installation)
Time Parameters	Réglages de la durée d'appel, de la durée d'affichage de l'image en temps réel, du délai de renvoi d'appel, de la durée de la sonnerie. Remarque : ces réglages peuvent également être modifiés directement dans le menu de l'écran.
Permission password	N'est pas utilisé dans la configuration à distance de l'écran.
Zone Alarm	Inutilisé
IP camera information	Ajout de caméras réseau ABUS. (Voir la liste de compatibilité) Jusqu'à 16 caméras réseau ABUS peuvent être ajoutées et visionnées en direct. (La caméra ne peut être ni lue ni configurée directement via la platine de rue)
Volume Input Output	(Voir les <u>consignes d'installation et de mise en service</u> )

▼  Network
 Local Network Configuration
 Linked Network Configuration
 Advanced Settings
 ABUS Link Station

Ring Import	Gestion de sonneries personnelles (voir les <u>consignes d'installation et de mise en service</u> )
Deploy Info	Inutilisé
Incoming Call Linkage	Inutilisé
Relay	Inutilisé
	<b>Section « Network »</b>
Local NetCfg	Adresse IP de l'écran. ( <b>Adresse IP, masque de sous-réseau, passerelle standard</b> )  <b>Port : 8000</b> inutile ici  <b>Port http</b> est inutile car aucune interface Web n'est présente
Linked network configuration	Affectation de l'écran principal au module vidéo de porte principal. Dans le cas d'un écran principal, l'adresse IP du module de porte principal est saisie ici. L'entrée « MainOutdoorUnit » ne doit pas être modifiée. <b>Remarque</b> : l'affectation du module vidéo de porte sur l'écran s'effectue généralement dès la configuration directement sur l'écran.
Advanced settings	Configuration du serveur DNS depuis l'écran.
ABUS Link Station	Configuration de l'accès via l'application ABUS Link Station. <b>Voir Réglages du service ABUS Link Station.</b> La connexion à l'application ABUS Link Station peut être établie facilement via l'interface sur l'écran.

## 9.12 Étendue des fonctions MODUVIS et application ABUS Link Station

L'interphone MODUVIS peut être intégré dans l'application ABUS Link Station. Les options suivantes sont disponibles :

Modifier Verification Code :	Le Verification Code doit d'abord être modifié dans l'option de menu « Service ABUS Link Station ». Pour ce faire, cliquez sur le code actuellement affiché.
Ajouter :	Scannez le code QR et ajoutez l'appareil à l'application. Il est ensuite nécessaire de saisir le Verification Code
Partager l'appareil :	L'interphone peut être partagé avec d'autres utilisateurs. Ainsi, plusieurs personnes ou applications ont accès à l'installation.
Option Push :	Lorsque la sonnette retentit sur l'interphone, l'application ABUS Link Station peut être appelée directement ou après un certain délai. L'appel peut être accepté via l'application et il est possible de dialoguer avec la platine de rue avec la vidéo. Si la qualité de réception ou la bande passante mobile est limitée, il est possible de désactiver la vidéo pour ne conserver que la voix.
Ouverture de porte :	Le relais 1 ou le relais 2 peut être activé avec l'application. Ceci permet d'actionner par ex. une gâche électrique.
Journal des événements :	L'application comprend une page de messages avec les entrées des dernières activités de sonnerie accompagnées d'une image d'événement.

## 9.13 Compatibilité avec les produits ABUS

Cette section porte sur l'interaction possible avec d'autres produits ABUS.

Produit ABUS	Compatibilité
Secvest	Non
WAppLoxx	Circuit relais
WAppLoxx Pro	Circuit relais
Caméras IP ABUS	Voir la liste de compatibilité <a href="http://www.abus.com">www.abus.com</a> , <a href="http://www.abus-sc.de">www.abus-sc.de</a>
ABUS NVR	Intégration de la vidéo de la platine de rue, voir la section 9.14
Application ABUS Link Station	Accès à l'image en temps réel de la platine de rue Message Push en cas de sonnerie

## 9.14 Intégration du module de porte vidéo dans ABUS NVR

L'image vidéo du module de porte vidéo peut également être intégrée dans un NVR ABUS. La vidéo est enregistrée en utilisant le protocole RTSP, qui permet uniquement un affichage permanent ou un enregistrement permanent (pas de détection de mouvement ou d'autres types d'enregistrement d'événement).

	Veillez noter les règles de protection des données en vigueur sur le site d'installation!
---	---

Les étapes suivantes sont nécessaires pour l'intégration:

1. Création d'un protocole défini par l'utilisateur dans la gestion des caméras du NVR ABUS.
2. Les détails de flux suivants doivent être utilisés:  
Protocole: RTSP  
Protocole de transfert: automatique  
Port: 554 (port standard)  
Chemin du flux: Streaming / Canaux / 101 (Flux principal)  
Streaming / Chaînes / 102 (sous-flux)
3. Lors de l'ajout d'un nouveau canal au NVR, ce protocole personnalisé sera sélectionné pour le module de porte vidéo.  
Le nom d'utilisateur («admin») et le mot de passe sont généralement les mêmes que ceux du moniteur du poste de porte. Si le mot de passe a été modifié via le logiciel CMS, ce mot de passe modifié doit être utilisé.

### 9.15 Bouton « gâche d'urgence » sur le module vidéo de porte

Un bouton / interrupteur peut être fixé au module vidéo de porte via l'entrée d'alarme 3 (AIN 3 = relais 1) et l'entrée d'alarme 4 (AIN 4 = relais 2) qui commute le relais de porte lorsqu'il est actionné.

Pour activer l'entrée d'alarme 3 (AI3 et AI4), ouvrez la configuration à distance du module vidéo de porte correspondant avec le logiciel ABUS CMS et réglez AI3 sur « openDoorBtn°»

L'AIN3 du module vidéo de porte ouvre maintenant la porte du relais 1  
L'AIN4 du module vidéo de porte ouvre maintenant la porte du relais 2

Pour des raisons de sécurité, cette fonction est désactivée à la livraison.

IO In Out

**IO In**

IO In No.: AI3

Use In: openDoorBtn

**IO Out**

IO Out No.: DOOR1

Use out: electricLock

Save

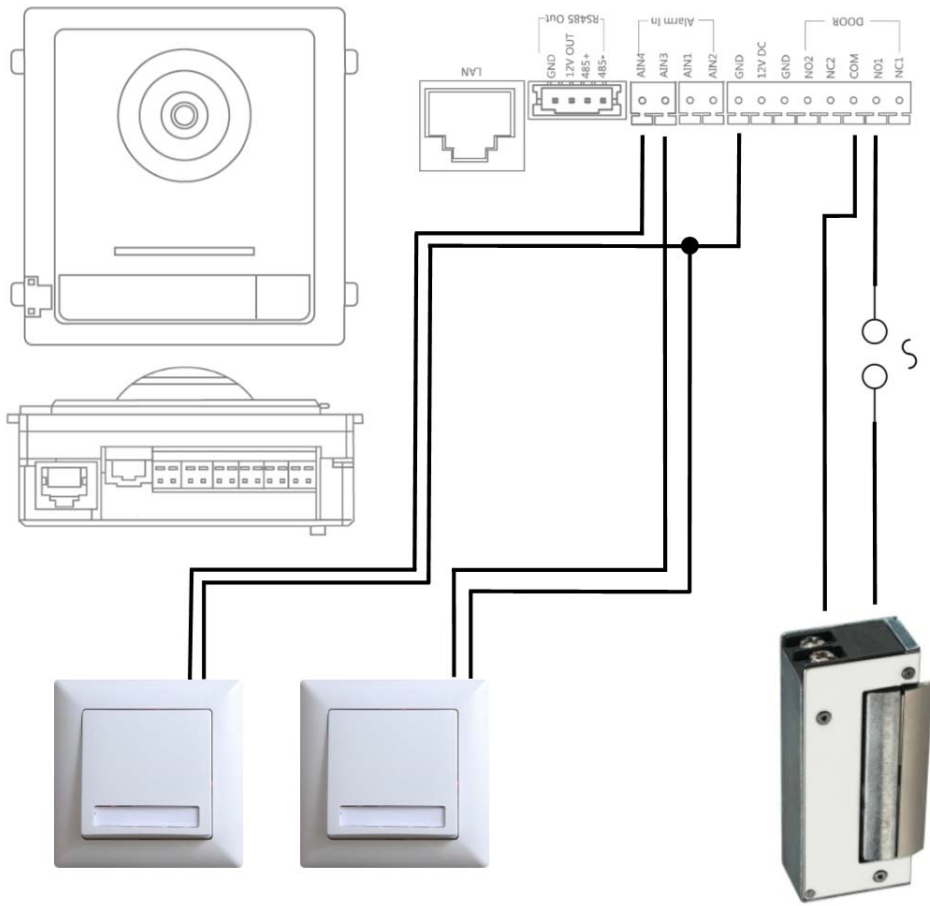

Max. 2A @ 30 VDC  
 Max. 0.5A @ 125 VAC

## 9.16 Circuit relais

Les relais du module vidéo de porte (TVHS20xxx), du module de sécurité TVHS10040 et des écrans TVHS20xxx peuvent être soumis à une charge max. de 2 A 30 VDC / 0,5 A 125 AC. Une surcharge entraîne le dysfonctionnement de l'appareil.

Veillez à déterminer la consommation électrique de votre gâche / serrure motorisée existante. En cas de dépassement de l'intensité admissible, nous recommandons de connecter un relais externe.

Le module vidéo de porte a une sortie de tension DC 12 V séparée. Ceci permet la connexion directe d'un relais auxiliaire externe sans alimentation électrique supplémentaire.

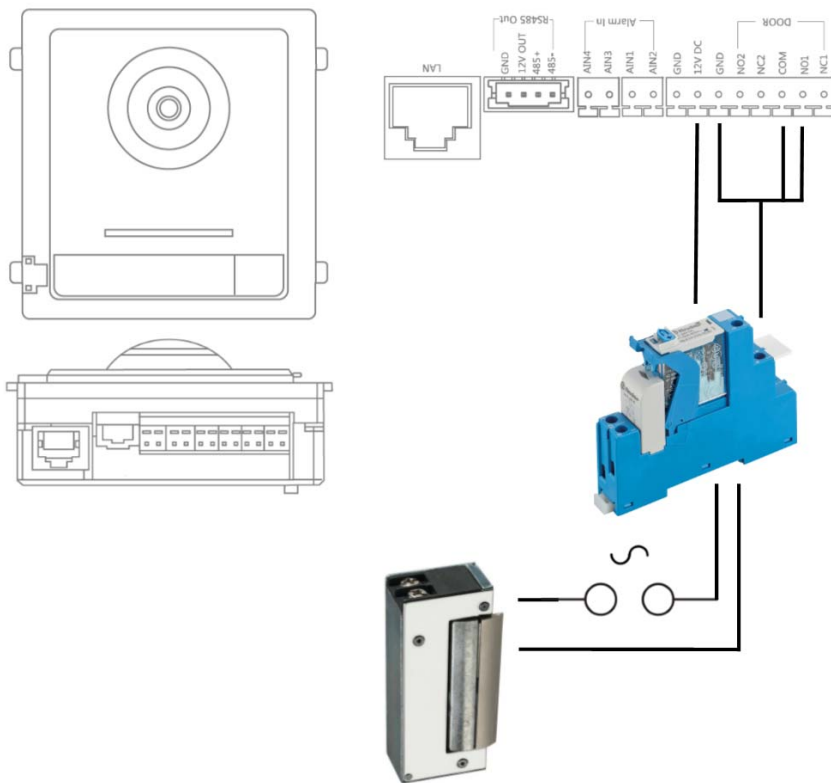

Relais sur profilé chapeau :

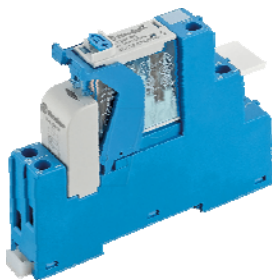

Exemple : carte relais 12 V déjà assemblée



### 9.17 Instructions de mesure de la gâche existante

Si vous souhaitez piloter une gâche existante et mais ne disposez d'aucune information sur la consommation électrique, vous devez déterminer si la consommation maximale ne surcharge pas le relais avant la connexion au relais du module vidéo de porte.

Pour ce faire, mesurez la consommation électrique de la gâche. Débranchez un câble sous tension et connectez l'appareil de mesure de courant en série.

### 9.18 Exemple d'application "module vidéo devant chaque porte d'appartement"

Souvent, il est souhaitable de placer également un module vidéo devant chaque porte d'appartement dans un immeuble afin d'obtenir une vidéo à 180 ° de la zone devant la porte de l'appartement (les judas sont généralement à angle très aigu dans votre domaine de vision).

Ceci peut être programmé pour jusqu'à 16 portes d'appartement à l'aide de la fonction «Entrée latérale» du module vidéo.

#### Variante LAN

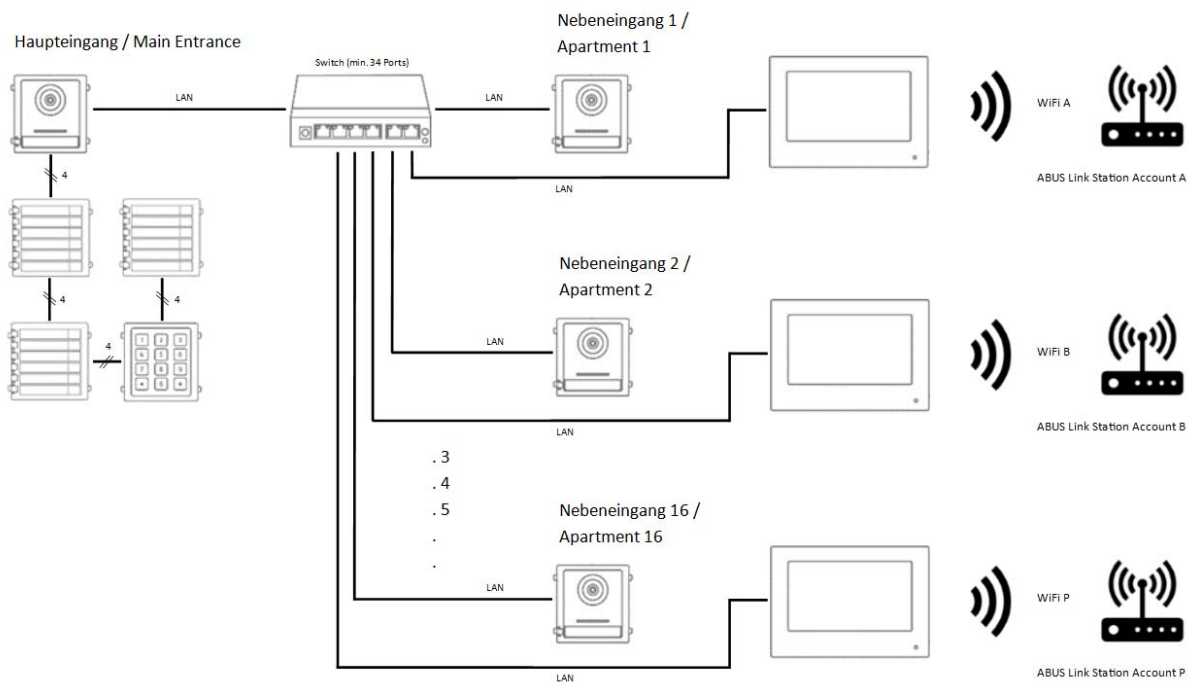

#### Variante 2 fils



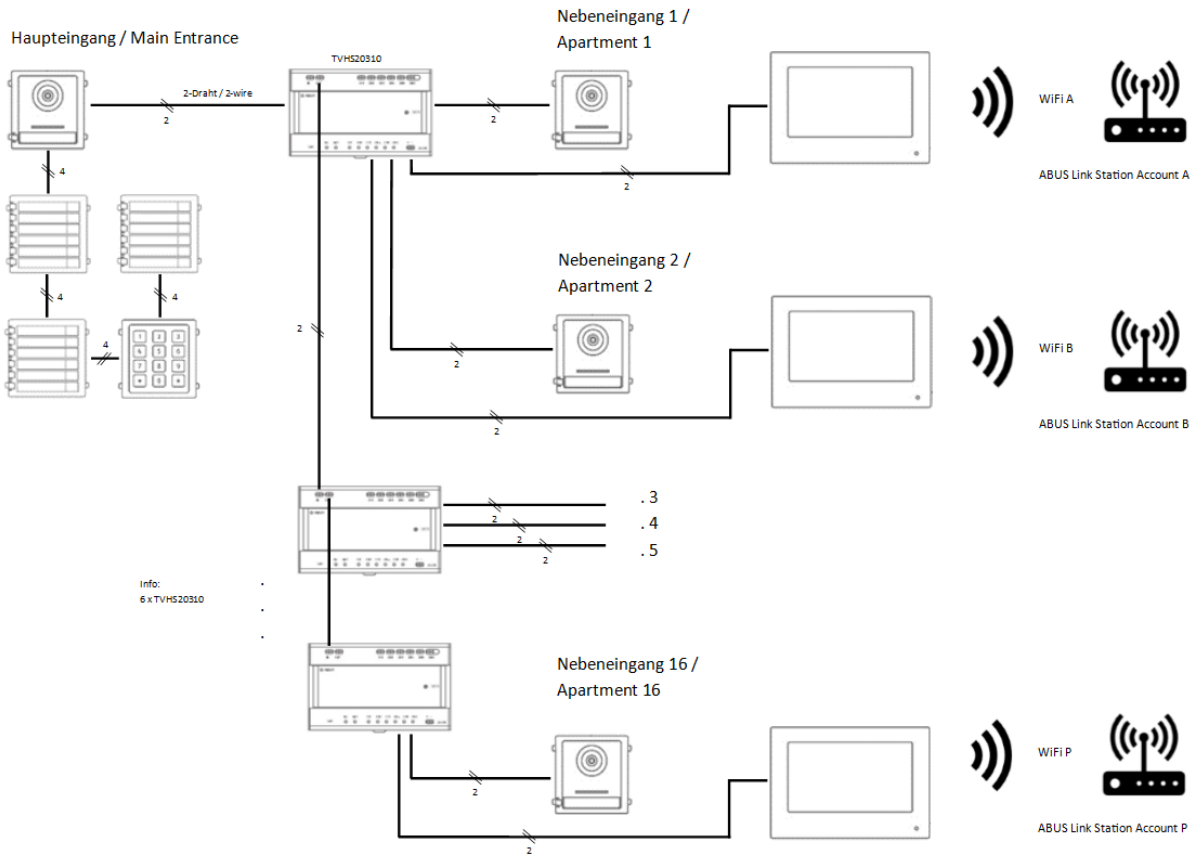

### Remote Configuration

- System
  - Device Information
  - General
  - Time
  - System Maintenance
  - User
  - RS485
- Intercom
  - ID Configuration
  - Time Parameters
  - Permission Password
  - Access and Elevator Control
  - IO Input/Output
  - Volume Input/Output
  - Dial
  - Motion Detection
  - Intercom Protocol
  - Sub Module
- Network
- Video Display
- CCD

#### Configuring the Room Numbers

**Device No. Configuration**

Device Type: Door Station

Project No.: 1

Community No.: 1

Building No.: 1

Floor No.: 1

No.: 1

Save

**Reboot**

Master Outdoor Device to Slave Device will cause the device to reboot, Are you sure?

OK Cancel

**Remote Configuration** ✕

- Time
- System Maintenance
- User
- RS485
- ▼ Intercom
  - ID Configuration
  - Time Parameters
  - Access and Elevator Control
  - IO Input/Output
  - Volume Input/Output

**Configuring the Network and Sip Parameters**

**Linked Network Configuration**

Device Type:

Master Station IP Address:

(Main) Door Station IP Address:

SIP Server IP Address:

Security Control Panel IP Address:

Security Control Panel Port No.:

**Remote Configuration** ✕

- ▼ System
  - Device Information
  - General
  - Time
  - System Maintenance
  - User
  - RS485
- ▼ Intercom
  - ID Configuration
  - Time Parameters
  - Permission Password
  - Access and Elevator Control
  - IO Input/Output
  - Volume Input/Output
- Dial
- Motion Detection
- Intercom Protocol
- Sub Module
- ▶ Network
- ▶ Video Display
- ▶ CCD

**Configuring the Key Call Room Parameters**

**Dial**

Number:

Room No.:

Quick Press for Calling Center

### 9.19 Exemple d'application "Accès WiFi individuel"

Dans un immeuble à appartements, il n'y a souvent pas de connexion Internet centrale pour toutes les unités résidentielles. Chaque unité résidentielle peut avoir sa propre connexion Internet.

Une connexion à la connexion Internet spécifique au client peut être établie via la fonction WiFi du moniteur principal.

Cela signifie qu'il y a également accès à la fonction ABUS Link Station avec notification push lorsque la sonnette sonne individuellement pour chaque unité résidentielle.

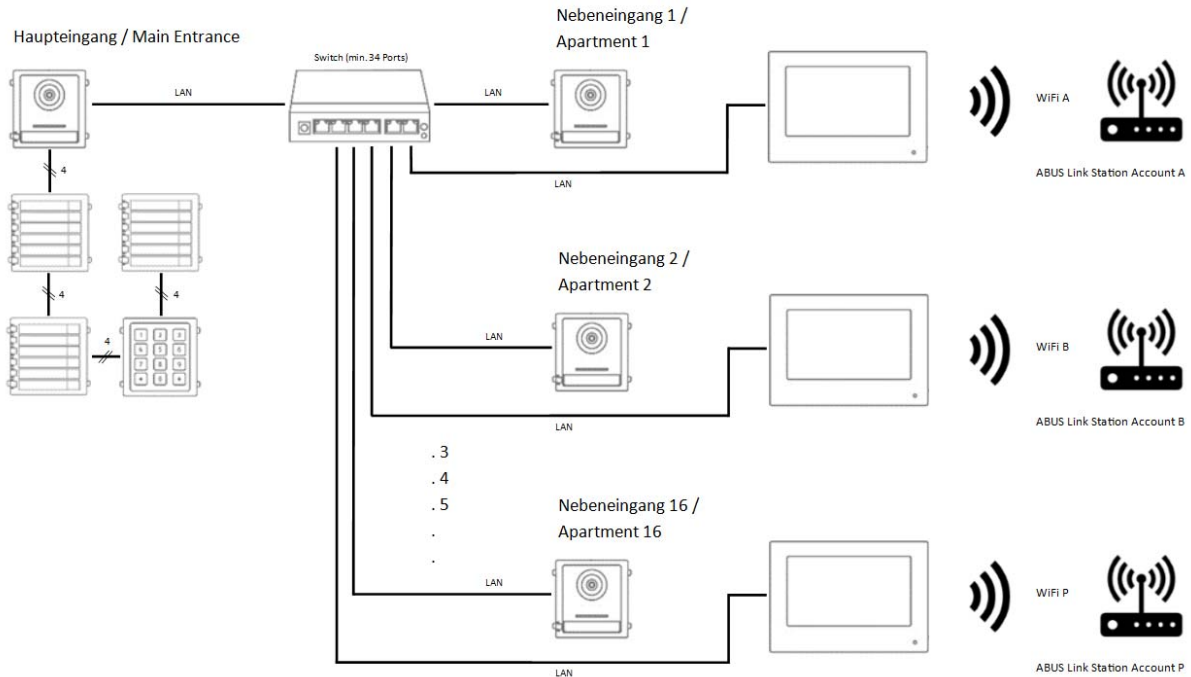

Wlan-Einstellungen		⚙️
📶	<input type="checkbox"/>	⚙️
MAX_MUSTERWLAN	📶	📶
		🔧

## **10. Guide de câblage (2 fils)**

Un document contenant de plus amples informations sur le câblage du système d'interphone de porte à 2 fils est disponible sur [www.abus.com](http://www.abus.com), par exemple sur le produit TVHS20010 :

[https://www.abus.com/var/ImagesPIM/d110001/medias/docus/25/Moduvis\\_Verkabelung\\_Wiring\\_2wire\\_V1.1.pdf](https://www.abus.com/var/ImagesPIM/d110001/medias/docus/25/Moduvis_Verkabelung_Wiring_2wire_V1.1.pdf)

## MODUVIS Deurintercom TVHS20XXX

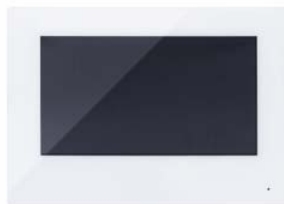

## Gebruikershandleiding

Versie 06/2021 (V1.2)



*Nederlandse vertaling van de originele Duitse handleiding. Bewaren voor toekomstig gebruik!*

## NL Inleiding

Geachte klant,

Hartelijk dank voor de aankoop van dit product.

### TVHS20000 / TVHS20000S

Het apparaat voldoet aan de eisen van de volgende EU-richtlijnen: EMC-richtlijn 2014/30/EU en RoHS-richtlijn 2011/65/EU.

### TVHS20010 / TVHS20010S

Het apparaat voldoet aan de eisen van de volgende EU-richtlijnen: EMC-richtlijn 2014/30/EU en RoHS-richtlijn 2011/65/EU.

### TVHS20020 / TVHS20020S

Het apparaat voldoet aan de eisen van de volgende EU-richtlijnen: EMC-richtlijn 2014/30/EU en RoHS-richtlijn 2011/65/EU.

### TVHS20030 / TVHS20030S

Het apparaat voldoet aan de eisen van de volgende EU-richtlijnen: EMC-richtlijn 2014/30/EU en RoHS-richtlijn 2011/65/EU.

### TVHS20040

Het apparaat voldoet aan de eisen van de volgende EU-richtlijnen: EMC-richtlijn 2014/30/EU en RoHS-richtlijn 2011/65/EU.

### TVHS20200

Hiermee verklaart ABUS Security-Center, dat het apparaat voldoet aan de RED-richtlijn 2014/53/EU. De apparaten voldoen bovendien aan de eisen van de onderstaande EU-richtlijnen: EMC-richtlijn 2014/30/EU en RoHS-richtlijn 2011/65/EU. De volledige tekst van de EU-conformiteitsverklaring kan worden geraadpleegd op de volgende internetadressen:  
[www.abus.com/product/TVHS20200](http://www.abus.com/product/TVHS20200)

### TVHS20210

Hiermee verklaart ABUS Security-Center, dat het apparaat voldoet aan de RED-richtlijn 2014/53/EU. De apparaten voldoen bovendien aan de eisen van de onderstaande EU-richtlijnen: EMC-richtlijn 2014/30/EU en RoHS-richtlijn 2011/65/EU. De volledige tekst van de EU-conformiteitsverklaring kan worden geraadpleegd op de volgende internetadressen:  
[www.abus.com/product/TVHS20210](http://www.abus.com/product/TVHS20210)

### TVHS20220

Hiermee verklaart ABUS Security-Center, dat het apparaat voldoet aan de RED-richtlijn 2014/53/EU. De apparaten voldoen bovendien aan de eisen van de onderstaande EU-richtlijnen: EMC-richtlijn 2014/30/EU en RoHS-richtlijn 2011/65/EU. De volledige tekst van de EU-conformiteitsverklaring kan worden geraadpleegd op de volgende internetadressen:  
[www.abus.com/product/TVHS20220](http://www.abus.com/product/TVHS20220)

### TVHS10040 / TVHS20340

Het apparaat voldoet aan de eisen van de volgende EU-richtlijnen: EMC-richtlijn 2014/30/EU en RoHS-richtlijn 2011/65/EU.

Om deze toestand te behouden en een veilig gebruik te garanderen, dient u als gebruiker deze gebruikershandleiding in acht te nemen!

Lees de complete gebruikershandleiding door voordat u het product in gebruik neemt. Neem alle gebruiks- en veiligheidsinstructies in acht!

**Alle genoemde bedrijfs- en productnamen zijn handelsmerken van de betreffende eigenaren. Alle rechten voorbehouden.**

**Neem bij vragen contact op met uw installateur of speciaalzaak!**



#### **Uitsluiting van aansprakelijkheid**

Deze gebruikershandleiding is met grote zorgvuldigheid opgesteld. Mocht u toch omissies of onnauwkeurigheden ontdekken, informeer ons dan hierover.

ABUS Security-Center GmbH & Co. KG aanvaardt geen aansprakelijkheid voor technische en typografische fouten en behoudt zich het recht voor te allen tijde, zonder aankondiging vooraf, wijzigingen aan het product en in de gebruikershandleidingen aan te brengen.

ABUS Security-Center is niet aansprakelijk of verantwoordelijk voor directe en indirecte gevolgschade die in verband met de uitrusting, de prestatie en het gebruik van dit product ontstaan. Voor de inhoud van dit document wordt geen enkele garantie gegeven.

## Belangrijke veiligheidsinstructies



**Bij schade die door het niet in acht nemen van deze gebruikershandleiding wordt veroorzaakt, vervalt het recht op garantie. We kunnen niet aansprakelijk worden gesteld voor gevolgschade!**



**Wij aanvaarden geen aansprakelijkheid voor materiële schade of letselschade, die door onjuist gebruik of het niet in acht nemen van de veiligheidsinstructies is veroorzaakt. In deze gevallen vervalt iedere aanspraak op garantie!**

**Geachte klant,**

**De volgende veiligheids- en gevareninstructies dienen niet alleen ter bescherming van uw gezondheid, maar zijn ook bedoeld voor de bescherming van het apparaat. Lees de volgende punten aandachtig door:**

- In het product bevinden zich geen onderdelen die onderhoud vereisen. Bovendien vervalt door het openen/demonteren de vergunning (CE) en de garantie/vrijwaring.
- Het product kan al beschadigd raken door een val van slechts geringe hoogte.

Vermijd bij gebruik de volgende ongunstige omgevingsomstandigheden:

- Vocht of te hoge luchtvochtigheid
- extreme kou of hitte
- direct zonlicht
- stof of brandbare gassen, dampen of oplosmiddelen
- sterke trillingen
- sterke magneetvelden, bijvoorbeeld in de buurt van machines of luidsprekers
- De camera mag niet op onstabiele oppervlakken worden geïnstalleerd.

Algemene veiligheidsinstructies:

- Laat het verpakkingsmateriaal niet onbeheerd achter! Plastic folie, plastic zakjes, stukken piepschuim e.d. kunnen gevaarlijk speelgoed zijn voor kinderen.
- De videobewakingscamera bevat kleine onderdelen die ingeslikt kunnen worden. Houd het apparaat daarom om veiligheidsredenen uit de buurt van kinderen.
- Steek geen voorwerpen door de openingen in het apparaat
- Gebruik alleen de hulpapparaten/hulpstukken die door de fabrikant zijn aangegeven. Sluit geen producten aan die niet compatibel zijn.
- Neem de veiligheidsinstructies en gebruikershandleidingen van de overige aangesloten apparaten in acht.
- Controleer het apparaat voor de ingebruikname op beschadigingen. Mocht u beschadigingen ontdekken, neem het apparaat dan niet in gebruik!
- Houdt u zich aan de bedrijfsspanningsgrenzen die in de technische gegevens staan vermeld. Hogere spanningen kunnen het apparaat beschadigen en uw veiligheid in gevaar brengen (elektrische schok).



Zorg er bij installatie in een bestaande videobewakingsinstallatie voor dat alle apparaten gescheiden zijn van net- en laagspanningsstroomkring.



In geval van twijfel dient u de montage, installatie en bedrading niet zelf uit te voeren, maar aan een specialist over te laten. Ondeskundige en amateuristische werkzaamheden aan het elektriciteitsnet of aan de huisinstallaties zijn niet alleen gevaarlijk voor uzelf, maar ook voor anderen.

Sluit de installaties zo op het kabelnet aan dat net- en laagspanningsstroomkringen altijd gescheiden bedraad en op geen enkele plaats met elkaar verbonden zijn of door een defect met elkaar verbonden kunnen raken.



## Inhoudsopgave

<b>1.</b>	<b>BEOOGD GEBRUIK.....</b>	<b>228</b>
<b>2.</b>	<b>VERKLARING VAN SYMBOLEN .....</b>	<b>228</b>
<b>3.</b>	<b>SYSTEEMOVERZICHT .....</b>	<b>229</b>
3.1	2-DRAADS VARIANT .....	231
3.1.1	COMPONENTEN .....	231
3.1.2	AANBEVOLEN KABELTYPEN .....	232
3.2	IP-NETWERKVARIANT .....	232
3.2.1	COMPONENTEN .....	232
3.3	INSTALLATIECOMPONENTEN .....	233
3.4	SYSTEEMVARIANTEN.....	234
<b>4.</b>	<b>INGEBRUIKNAME .....</b>	<b>239</b>
4.1	BEDRADING .....	239
4.1.1	INSTALLATIE HOOGTE .....	239
4.2	ACTIVERINGSOPTIES / EERSTE WACHTWOORDTOEWIJZING .....	240
4.2.1	ACTIVERING VIA DEURMONITOR .....	240
4.2.2	ACTIVERING VIA IP-NETWERK .....	244
4.2.3	RESET WACHTWOORD MONITOR/VIDEODEURMODULE .....	244
<b>5.</b>	<b>BEDIENING VAN DE MONITOR (2-DRAADS EN IP) .....</b>	<b>245</b>
5.1	LIVEBEELD.....	245
5.2	HOOFDPAGINA OVERZICHT .....	246
5.2.1	MENUPUNT: OPROEPIINSTELLINGEN.....	251
5.2.2	WLAN-INSTELLINGEN .....	253
5.2.3	ETAGEBELDRUKKER.....	254
5.2.4	OVERIGE INSTELLINGEN .....	255
5.2.4.1	CONFIGURATIE – LOKALE INFORMATIE .....	255
5.2.4.2	CONFIGURATIE – NETWERKINSTELLINGEN.....	259
5.2.4.3	CONFIGURATIE – APPARAATBEHEER.....	260
5.2.4.4	CONFIGURATIE – STANDAARDINSTELLINGEN .....	262
5.2.4	RELAISCONFIGURATIE .....	262
5.2.5	MICROSD-KAART .....	263
5.2.6	SCHERM VERGRENDELEN .....	263
5.2.7	APPARAATGEGEVENS.....	263
5.2.8	TIJD INSTELLEN.....	263
5.2.9	APPARAAT OPNIEUW OPSTARTEN .....	263
5.2.10	WACHTWOORDINSTELLINGEN (PINCODE) .....	264
5.2.11	SYSTEEMTAAL .....	265
5.2.12	HELDERHEIDSINSTELLING.....	265
5.2.13	ETAGEBELDRUKKER.....	265
5.2.14	OPEN SOURCE LICENTIE-INFORMATIE .....	265
<b>6.</b>	<b>ONDERHOUD EN REINIGING.....</b>	<b>266</b>
6.1	FUNCTIETEST .....	266
6.2	REINIGING .....	266
<b>7.</b>	<b>AFDANKEN .....</b>	<b>266</b>

<b>8.</b>	<b>OPEN SOURCE LICENTIE-INFORMATIE.....</b>	<b>266</b>
<b>9.</b>	<b>INSTRUCTIES VOOR INSTALLATIE- EN INGEBRUIKNAME .....</b>	<b>267</b>
9.1	VEILIGHEIDSMODULE GEBRUIKEN (TVHS10040/TVHS20340) .....	267
9.2	NEVENINGANGEN INSTALLEREN .....	269
9.3	EXTRA BELDRUKKERS (TVHS20020) VOOR EEN MEERGEZINSWONING INSTELLEN.....	271
9.4	VOLUME OP DE DEURVIDEOMODULE (TVHS20000, TVHS20010) INSTELLEN .....	274
9.5	BESTAANDE VOORDEURBEL AANSLUITEN .....	275
9.6	BESTAANDE DEUROPENERS OP DE MONITOR VAN DEURSTATION AANSLUITEN.....	276
9.7	ETAGEBELDRUKKER OP DE HOOFDMONITOR AANSLUITEN .....	277
9.8	ELEKTRISCHE DEUROPENER OP VIDEOMODULE (INCL. "TUINDEUR") AANSLUITEN .....	278
9.9	EIGEN BELTONEN IN DE MONITOR VAN HET DEURSTATION LADEN.....	280
9.10	ABUS CMS: FIRMWARE MODUVIS-COMPONENTEN UPDATE .....	282
9.11	ABUS CMS: GEAVANCEERDE INSTELMOGELIJKHEDEN .....	283
9.12	FUNCTIE-OMVANG MODUVIS EN ABUS LINK STATION APP .....	286
9.13	COMPATIBILITEIT MET ABUS-PRODUCTEN .....	287
9.14	VIDEODEURMODULE IN ABUS NVR INTEGREREN .....	287
9.15	"NOODDEUROPENER" KNOP OP DE DEURVIDEOMODULE.....	288
9.16	RELAISCIRCUIT .....	290
9.17	HANDLEIDING VOOR METEN VAN BESTAANDE DEUROPENER .....	291
9.18	TOEPASSINGSVOORBEELD "VIDEOMODULE VOOR ELKE WONINGDEUR" .....	291
9.19	TOEPASSINGSVOORBEELD "INDIVIDUELE WIFI-TOEGANG" .....	294
<b>10.</b>	<b>BEDRADINGSGELEIDER (2-DRAADS).....</b>	<b>295</b>

## 1. Beoogd gebruik

Deze MODUVIS-deurintercom is een intercomsysteem met videoweergave van het deurbereik. Het systeem kan worden gebruikt voor een- en meergezinswoningen. Met extra monitoren in een woonunit kan het systeem ook worden gebruikt als een intercomsysteem (zonder video) binnen de woonunit.

De MODUVIS-deurintercom is geen videobewakingsinstallatie en mag niet als zodanig worden gebruikt.



Een ander gebruik dan hierboven beschreven kan tot beschadiging van het product leiden. Daarnaast bestaan er andere gevaren. Elk ander gebruik geldt als niet-beoogd en leidt tot het verlies van de garantie; elke aansprakelijkheid wordt uitgesloten. Dit geldt ook als er verbouwingen en/of veranderingen aan het product uitgevoerd zijn.

Lees de gebruikershandleiding helemaal en aandachtig door voordat u het product in gebruik neemt. In de gebruikershandleiding staat belangrijke informatie over de montage en bediening.

## 2. Verklaring van symbolen



Het symbool met de bliksemschicht in een driehoek wordt gebruikt wanneer er gevaar voor de gezondheid is, bijvoorbeeld door een elektrische schok.



Een driehoek met uitroeptekens wijst op belangrijke instructies in deze gebruikershandleiding die altijd in acht genomen moeten worden.



Dit symbool wijst op bijzondere tips en instructies over de bediening.

### 3. Systemoverzicht

Deze deurintercom is verkrijgbaar met twee verschillende bedradingstechnologieën:

2-draads variant: De communicatie en voeding lopen via 2 draden (1 paar). De bedrading is stervormig, het centrale punt is een 2-draads verdeler. Een basissysteem bestaat uit een 2-draads verdeler, een 2-draads monitor en een 2-draads videomodule.

IP-variant: De communicatie en voeding lopen via een ethernetkabel (netwerkkabel). De componenten ondersteunen Power-over-Ethernet (PoE) (optioneel 12 VDC). De bekabeling is stervormig, het centrale punt is de (PoE)-switch. Een basissysteem bestaat uit een IP-monitor en een IP-videomodule.

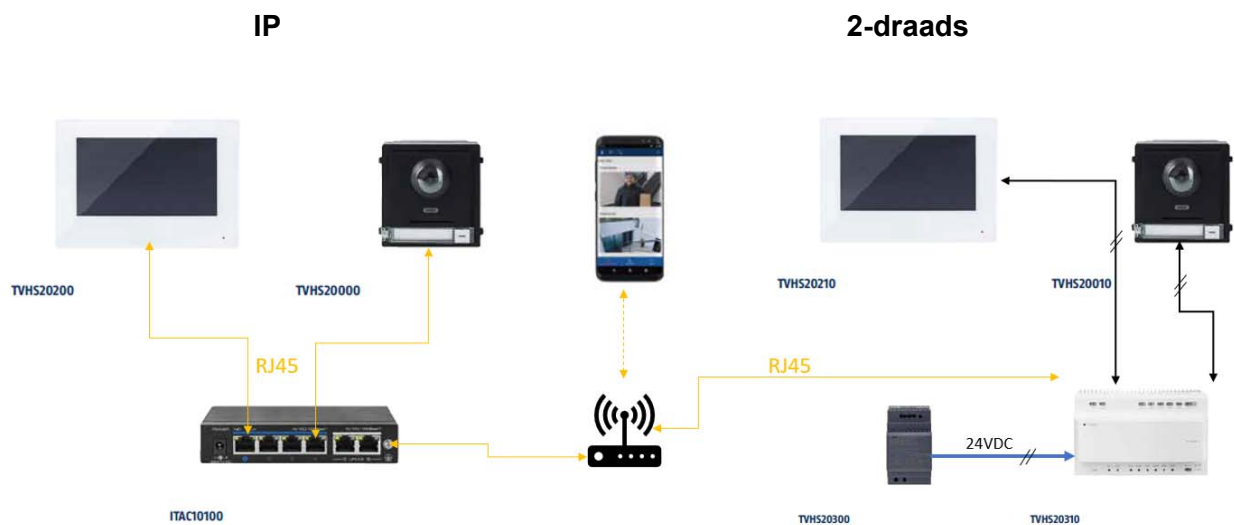

**Beide systeemvarianten kunnen worden gecombineerd. Hierdoor is een optimale aanpassing aan de bestaande bouwkundige situatie mogelijk.**

Voorbeelden van gecombineerde systemen:

Dit voorbeeld toont de gemengde werking van een hoofdmonitor via 2-draads en een uitbreidingsmonitor via wifi.

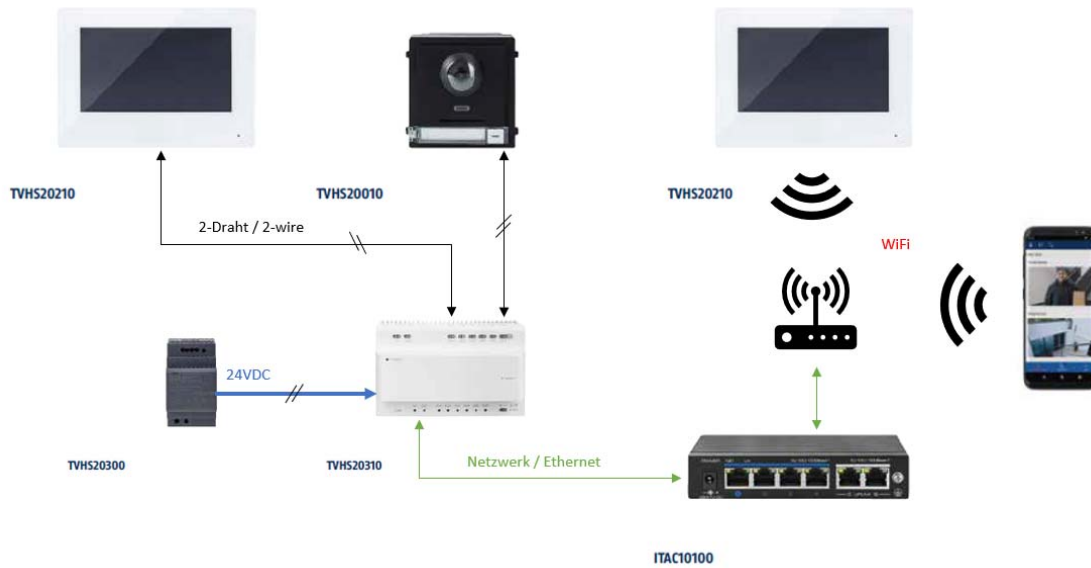



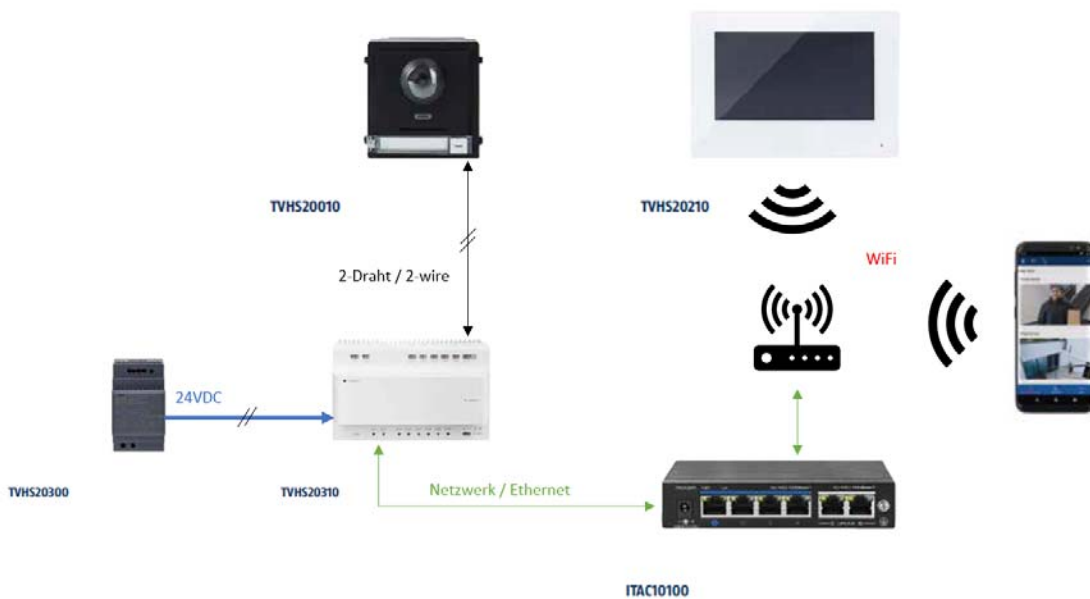



Dit voorbeeld toont de gemengde werking van een videodeurmodule via 2-draads met een hoofdmonitor via wifi.

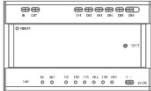

### 3.1 2-draads variant

#### 3.1.1 Componenten

<p>TVHS20210</p>  <p>2-draads monitor</p>	<p>TVHS20010 / TVHS20010S</p>  <p>2-draads videomodule</p>	<p>TVHS20310</p>  <p>2-draads verdeler</p>
<p>TVHS20020 / TVHS20020S</p>  <p>Beldrukkermodule (6 beldrukkers)</p>	<p>TVHS20030 / TVHS20030S</p>  <p>Numeriek toetsenblok</p>	<p>TVHS20040</p>  <p>Informatiemodule</p>
<p>TVHS20300</p>  <p>24VDC-netstekervoeding voor DIN-rail</p>	<p>TVHS10040 / TVHS20340</p>  <p>Veiligheidsmodule</p>	

### 3.1.2 Aanbevolen kabeltypen

Kies het kabeltype op basis van de afstand tussen de videomodule, de verdeler en de monitor.

2-draads videomodule (TVHS20010 / TVHS20010S)





2-draads monitor (TVHS20210)

2-draads verdeler (TVHS20310)

Kabeltype	24AWG (10 $\Omega$ per 100m)	20AWG (7 $\Omega$ per 100m)	18AWG (4 $\Omega$ per 100m)
<b>Kabelroute</b>			
TVHS20310 / TVHS20310	Max. 60 m	Max. 60 m	Max. 60 m
TVHS20010(S) / TVHS20310	Max. 35 m	Max. 60 m	Max. 60 m
TVHS20210 / TVHS20310	Max. 35 m	Max. 60 m	Max. 60 m









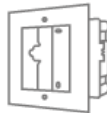
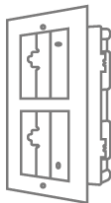

## 3.2 IP-netwerkvariant

### 3.2.1 Componenten

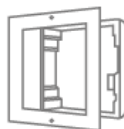
TVHS20200 / TVHS20220 " data-bbox="185 561 291 615"/> IP 7"/10" PoE-monitor	TVHS20000 / TVHS20000S  IP-videomodule	TVHS20020 / TVHS20020S  Beldrukkermodule (6 beldrukkers)
TVHS20030 / TVHS20030S  Numeriek toetsenblok	TVHS20040  Informatiemodule	TVHS10040 / TVHS20340  Veiligheidsmodule

### 3.3 Installatiecomponenten

Deze beschikbare installatiecomponenten kunnen zowel voor de 2-draads als voor de IP-variant van de Moduvis-deurintercom met video worden gebruikt.

<p>TVHS20050</p>  <p>Leeg paneel</p>	<p>TVHS20060</p>  <p>Paneel voor ongebruikte beldrucker</p>	<p>TVHS20100(S)</p>  <p>Frame voor 1 module inbouwmontage</p>
<p>TVHS20110(S)</p>  <p>Frame voor 2 modules inbouwmontage</p>	<p>TVHS20120(S)</p>  <p>Frame voor 3 modules inbouwmontage</p>	<p>TVHS10130(S)</p>  <p>Frame voor 1 module opbouwmontage</p>
<p>TVHS10140(S)</p>  <p>Frame voor 2 modules opbouwmontage</p>	<p>TVHS10150(S)</p>  <p>Frame voor 3 modules opbouwmontage</p>	<p>TVHS20160</p>  <p>Buitenbehuizing voor frame opbouwmontage (1 module)</p>
<p>TVHS20170</p>  <p>Buitenbehuizing voor frame opbouwmontage (2 modules)</p>	<p>TVHS20180</p>  <p>Buitenbehuizing voor frame opbouwmontage (3 modules)</p>	

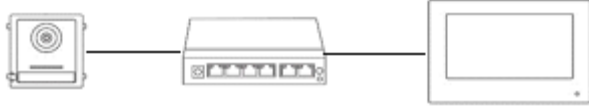
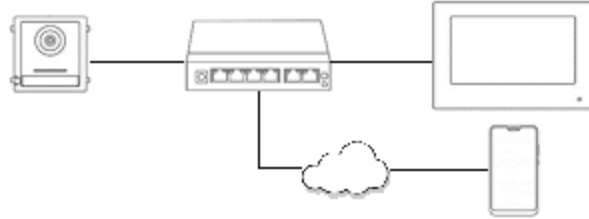
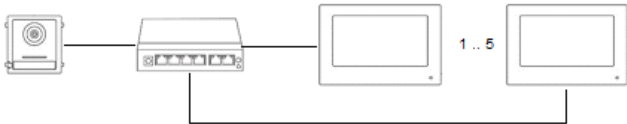
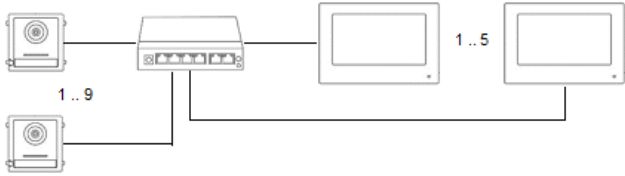
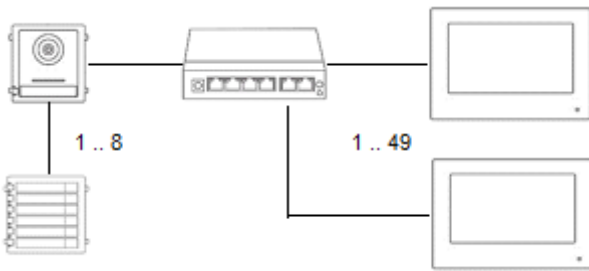

### 3.4 Systemvarianten

#	Technologie / bedrading	Systeemopbouw	Toepassingsvoorbeeld
1	IP		Eengezinswoning
2	IP		Eengezinswoning met toegang via app
3	IP		Eengezinswoning met extra binnenmonitoren binnen
4	IP		Eengezinswoning met extra binnenmonitoren en neveningen
5	IP		Meergezinswoning

6	IP		<b>Meergezinswoning met extra binnenmonitoren</b>
7	IP		<b>Meergezinswoning met extra binnenmonitoren en numeriek toetsenblok</b>
8	IP		<b>Meergezinswoning met extra binnenmonitoren, numeriek toetsenblok en verlichte infomodule</b>
9	2-draads		<b>Eengezinswoning</b>
10	2-draads		<b>Eengezinswoning met zij-ingang</b>

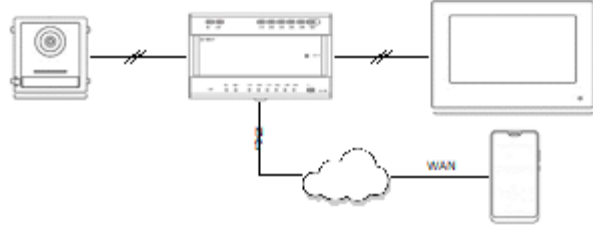
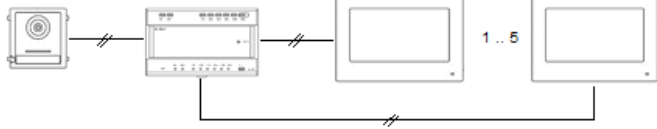
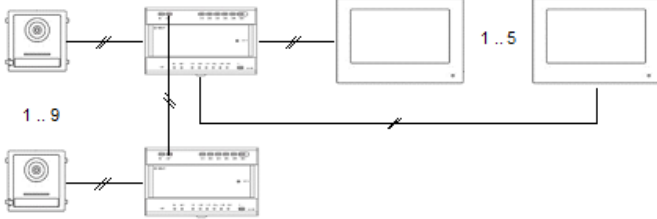
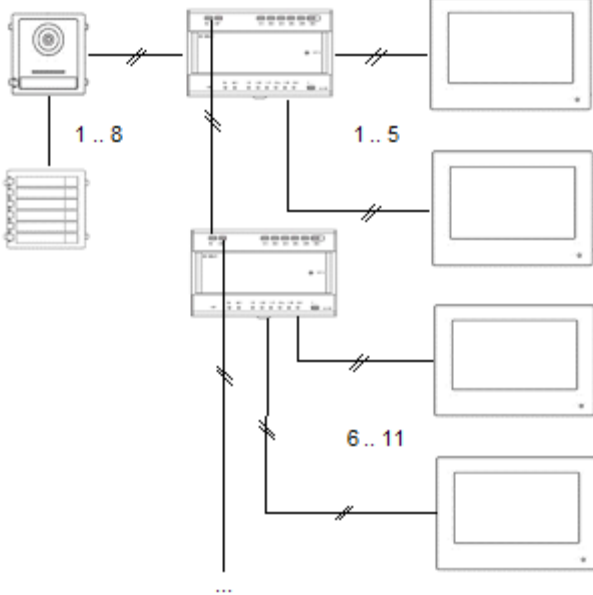
11	2-draads		<b>Eengezinswoning met toegang via app</b>
12	2-draads		<b>Eengezinswoning met extra binnenmonitoren binnen</b>
13	2-draads		<b>Eengezinswoning met extra binnenmonitoren en neveningangen</b>
14	2-draads		<b>Meergezinswoning</b>

15	2-draads	<p>... max. 49</p>	<b>Meergezinswoning met extra binnenmonitoren</b>
16	2-draads	<p>... max. 43</p>	<b>Meergezinswoning met extra binnenmonitoren en numeriek toetsenblok</b>
17	2-draads	<p>... max. 37</p>	<b>Meergezinswoning met extra binnenmonitoren, numeriek toetsenblok en verlichte infomodule</b>
18	2-draads / IP		<b>Combinatie 2-draads en IP-technologie:</b>  <b>extra binnenmonitor via wifi-verbinding</b>

	<p><b>AANWIJZING</b></p> <p>Elke monitor en deurvideomodule verschijnt afzonderlijk in het netwerk en heeft een eigen IP-adres. Hierbij is het niet van belang of de systemen via het PoE-netwerk of in het geval van de 2-draads variant op de "2-draads verdeler" zijn aangesloten. De monitor "TVHS20200 / TVHS20220" kan ook via WLAN in de netwerkstructuur worden geïntegreerd.</p>
---	---

	<p><b>AANWIJZING</b></p> <p>Elk eindapparaat moet rechtstreeks op de verdeleenheid worden aangesloten. Doorsturen van de ene monitor naar de andere is niet toegestaan.</p>
---	---

## **4. Ingebruikname**

### **4.1 *Bedrading***

Voor gedetailleerde bedradingsinstructies wordt verwezen naar de korte handleiding die bij de producten is gevoegd.

#### **4.1.1 *Installatie hoogte***

De montagehoogte van de videomodule TVHS20000(S) of TVHS20010(S) mag niet minder zijn dan 1,40 m (bovenrand). Anders kan het gebeuren dat mensen die te dicht bij de videomodule staan, niet aan hun gezicht kunnen worden herkend.

## 4.2 Activeringsopties / eerste wachtwoordtoewijzing

### 4.2.1 Activering via deurmonitor

- 1) De voeding van het systeem en het deurstation moeten zich hiervoor in hetzelfde netwerk bevinden.

Wijs een wachtwoord toe bij de eerste installatie van de monitor. Dit wachtwoord wordt ook automatisch gebruikt om het deurstation te activeren. Dit wachtwoord is ook nodig voor het met een wachtwoord beveiligde gedeelte van de monitor.

- 8-16 tekens
- geldige tekens: cijfers, kleine letters, hoofdletters, speciale tekens (! \$ % & / ( ) = ? + - )
- er moeten 2 verschillende soorten tekens worden gebruikt

- 2) Kies de gewenste taal en bevestig dit met de toets "VERDER".

	Wizard taal 1/4
English	
Deutsch	
Italiano	
Francais	
Nederlands	

	<b>Firmware-release-opmerking</b> Functie: Nederlandse taal Videomodule (THVS20000(S) / TVHS20010(S)): V2.2.3_build_201029 Monitor (TVHS20200 / 210 / 220): V2.1.2_build_201029
---	--

- 3) Kies nu tussen DHCP / vast IP-adres. Het wordt sterk aanbevolen om een vast IP-adres toe te wijzen aan elk afzonderlijk apparaat, anders kan in geval van een stroomstoring een nieuw IP-adres worden toegewezen en kunnen ernstige systeemstoringen optreden.

Wizard netwerk 2/4	
DHCP	<input type="checkbox"/>
Lokale IP	192.168.0.11
Subnetmasker	255.255.255.0
Gateway	192.168.0.1

	<p><b>Notitie</b></p> <p>Als je de schakelaar voor de DHCP-functie indrukt, springt de schakelaar eerst naar rechts en dan weer naar links. Op dit moment wordt er een IP-adres opgehaald van de DHCP-server, die vervolgens als vast IP-adres in het apparaat wordt ingesteld.</p>
---	---

- 4) Kies het type monitor dat u wilt instellen.

Wizard netwerk 3/4	
Binnenstation Type	Binnenstation <span style="float: right;">&gt;</span>
Etage	0
Appartementnr.	1

**Binnenstation:**

De monitor wordt de hoofdmonitor van een deurintercomsysteem. Hier maakt het niet uit of er een eengezinswoning of een meergezinswoning wordt geïnstalleerd. De hoofdmonitor van een appartement krijgt bij de installatie altijd het type "binnenstation". Als u slechts één bedrukker en één appartement gebruikt, blijft het appartementnummer op "1" staan. Zodra er meerdere appartementen/hoofdmonitoren worden gebruikt, moet het appartementnummer worden aangepast.

Voorbeeld: Appartement 1 => appartementnummer 1  
 Appartement 2 => appartementnummer 2  
 (etc...)

Alleen op deze manier kunnen de bedrukkers aan de verschillende partijen worden toegewezen.



**Aanwijzing:** Een hoofdmonitor (binnenstation) moet altijd verbonden zijn met het hoofddeurstation in het systeem.

#### **Extra binnenmonitor:**

De monitor wordt gebruikt als extra monitor in een systeem om een monitor in extra ruimtes te installeren. Alle extra monitoren worden verbonden met de hoofdmonitor en bieden bij een inkomende oproep dezelfde functies als de hoofdmonitor.



U kunt maximaal 5 extra monitoren aansluiten op één hoofdmonitor. (Nr. 1-5). Bovendien kan de "ruimtenaam" worden toegewezen. Deze verschijnt op de andere monitoren in het systeem automatisch onder "Contacten".

**Aanwijzing:** Een extra monitor (binnen) moet altijd worden gekoppeld aan de hoofdmonitor in het systeem!

Bij het installatietype "extra binnenmonitor" zijn de volgende menupunten niet beschikbaar op de monitor. **Deze kunnen alleen op de hoofdmonitor van het systeem worden ingesteld/opgeroepen:**

- "Automatisch aannemen" van het antwoordapparaat in-/uitschakelen.
- Berichten op antwoordapparaat beluisteren
- ABUS LINK station app – menu
- Netwerkcamera's toevoegen
- Configuratie netwerkadres en reset fabrieksinstellingen op de randapparaten

5) "Wizardgebonden apparaten"

Wizardgebonden apparaten				
Zoeken op serienummer				
ABUS artikelnummer	IP-adres	Firmwareversie	Activeren	
				
ABUS artikelnummer	IP-adres	Firmwareversie	Activeren	
				
ABUS artikelnummer	IP-adres	Firmwareversie	Activeren	
				

Hier ziet u de beschikbare netwerkapparaten van de TVHS20xxx deurstationserie.

Als een hoofdmonitor is ingesteld, moet hier het hoofddeurstation worden geselecteerd.  
Als een extra binnenmonitor is ingesteld, moet hier de hoofdmonitor worden geselecteerd.

Hier heeft u de mogelijkheid om ook het deurstation te "activeren". De hoofdmonitor activeert dan automatisch het deurstation met hetzelfde wachtwoord als de monitor.

Kies hiervoor het hoofddeurstation in de lijst en klik op "Activeren". Kies na succesvolle activering het deurstation. Er verschijnt een groen bevestigingsvinkje aan de linkerkant van de lijst. Het deurstation is nu geactiveerd en met succes gekoppeld.

Als er geen apparaat in het netwerk wordt gevonden, zorg er dan voor dat het deurstation zich in hetzelfde netwerk bevindt en stroom heeft.

Met het bijbehorende "tandwiel" worden de IP-instellingen van de apparaten geopend. Hierdoor kan het IP-adres van de deurvideomodule worden aangepast.

Als u naast een deur nog meer neveningen wilt toevoegen, ga dan naar het hoofdstuk "9.2 Neveningen installeren" onder Instructies voor installatie- en ingebruikname.

### 4.2.2 Activering via IP-netwerk

Installeer en start de ABUS IP Installer die beschikbaar op de ABUS-website [www.abus.com](http://www.abus.com) bij het betreffende product.

Ieder verbonden apparaat zou nu in de keuzelijst moeten verschijnen, eventueel nog niet met het bij het doelnetwerk passende IP-adres.

Als eerste moet ieder apparaat worden geactiveerd, d.w.z. er moet een veilig wachtwoord aan de hoofdgebruiker "admin" worden toegewezen. Een veilig wachtwoord moet minimaal voldoen aan de onderstaande eisen:

- 8-16 tekens
- Geldende tekens: cijfers, kleine letters, hoofdletters, speciale tekens (! \$ % & / ( ) = ? + -)
- 2 verschillende soorten tekens moeten worden gebruikt

De IP-instellingen van de camera kunnen met de IP Installer worden gewijzigd.

De knop "Browser" is niet beschikbaar voor de componenten van het deurintercomsysteem, omdat deze geen eigen webserver hebben.

De componenten kunnen zoveel mogelijk via de monitor van de deurintercom worden geprogrammeerd. Complexere systeemstructuren moeten echter via de CMS-software worden geprogrammeerd (integratie van een component zoals een IP-apparaat, openen van het menupunt "Configuratie op afstand").

	Ook de activering in het IP-netwerk kan met behulp van de ABUS CMS-software worden uitgevoerd.
	De ABUS CMS-software kan ook nodig zijn voor bepaalde verdere instelstappen.

### 4.2.3 Reset wachtwoord monitor/videodeurmodule

Om het wachtwoord van de monitor of de videodeurmodule te resetten, kunt u contact opnemen met onze technische support.

## 5. Bediening van de monitor (2-draads en IP)

### 5.1 Livebeeld

Knop/weergave	Beschrijving
	Neemt de oproep aan en opent de video-/spraakverbinding.
	Beëindigt een oproep en hangt op.
	Slaat een directe snapshot van het huidige videobeeld op
	<p>Opent de deur. Als er meerdere relaisuitgangen tegelijk worden gebruikt, zijn er maximaal 3 sleutelsymbolen. (2x deurrelais in de deurvideomodule, 1x deurrelais in de monitor).</p> <p>Hulp bij het aansluiten van een deuropener op het relais of bij het gebruik van de veiligheidsmodule TVHS10040 is te vinden in de sectie <u>Instructies voor installatie- en ingebruikname</u> in het hoofdstuk "9.8 Elektrische deuropener op videomodule (incl. "tuindeur") aansluiten" en "9.1 Veiligheidsmodule gebruiken (TVHS10040/TVHS20340)"</p>

## 5.2 Hoofdpagina overzicht

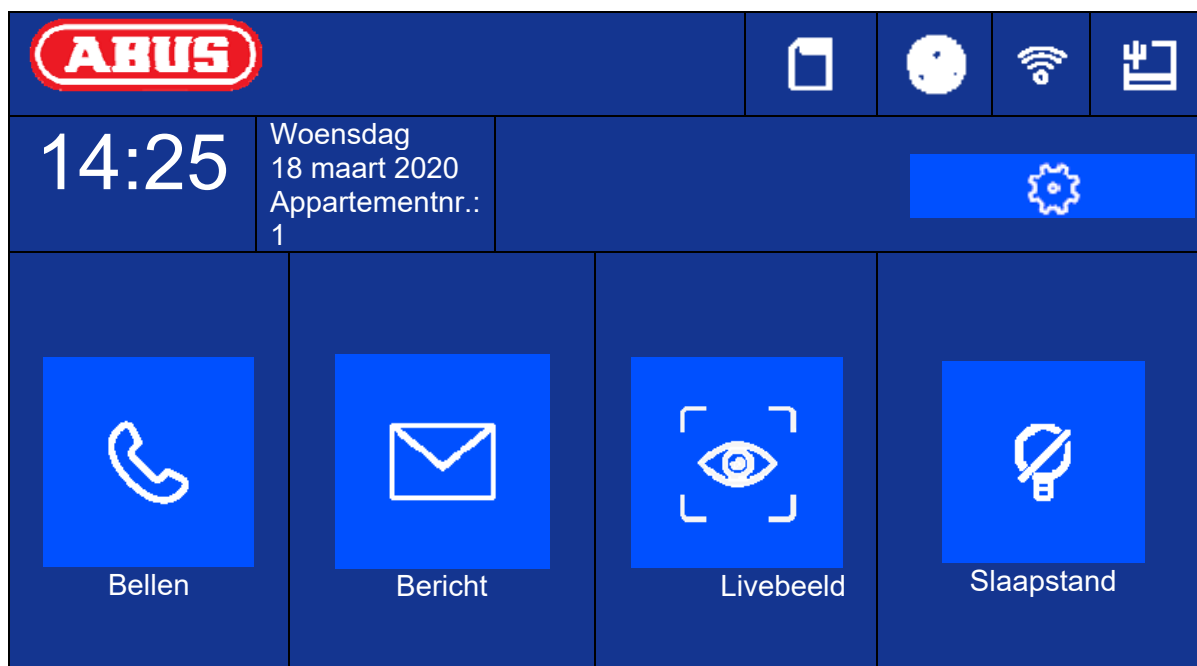

















Knop/weergave	Beschrijving
Tijd	Weergave van tijd  Door één keer op het scherm te tikken verschijnt de dialoog voor het instellen van datum en tijd.
Weekdag/datum	Weergave van de huidige weekdag Weergave van de datum
Appartementnummer	Weergave van het geconfigureerde appartementnummer van dit binnenstation. Max. 49 appartementen per systeem mogelijk.
[Oproep]	Intercomoproep naar binnenstation of extra binnenmonitor opbouwen.  Contacten weergeven/beheren  Oproeplogboek bekijken (incl. informatie over de belstation, foto, datum, tijd)
[Bericht]	Informatie over mededelingen, berichten van bezoekers en foto's van aangenomen oproep
[Livebeeld]	Livebeeld van aangesloten deurstations en geconfigureerde netwerkcamera's weergeven
[Instellingen / tandwiel]	Algemene oproepinstellingen: beltoon, belduur, oproepduur, oproepomleiding, microfoonvolume, belvolume, toetstoon, automatisch aannemen, modus niet storen  WLAN-instellingen voor de monitor (alleen te gebruiken bij de IP-variant!)

	Verdere apparaatinstellingen: configuratie (systeem), relaisgedrag, microSD-kaart, tijd, schermhelderheid
[Slaapstand]	Scherm onmiddellijk deactiveren







## Bellen

Oproepen starten tussen de appartementen of extra monitoren. Hier kunnen ook contacten worden aangemaakt. Een extra binnenmonitor wordt automatisch aangemaakt.

	*Oproepnummer invoeren (0-0 voor binnenstation, 0-1 extra binnenstation nr.1)				
					
					
					

















## Contactenlijst

Hier kunt u aangemaakte contacten bewerken of verwijderen. Om te wissen, drukt u 3 seconden op de contactregel. Het menu voor het verwijderen van contacten verschijnt.





	Contactenlijst		
Room 1			
			
			

## Oproeplogboek

Geeft de inkomende oproepen/beloproepen weer. Bovendien is een snapshot direct toegankelijk.

	Oproeplogboek			
	Hoofddeurstation		14-03-2020 11:21:08	
	Hoofddeurstation		14-03-2020 10:55:37	
	Hoofddeurstation		14-03-2020 10:55:37	
	Hoofddeurstation		14-03-2020 10:55:37	
	Hoofddeurstation		14-03-2020 10:55:37	
	Hoofddeurstation		14-03-2020 09:55:37	







## Aanwijzing

	Aanwijzing		
Geen aanwijzing		...	 















## Bericht van bezoekers (antwoordapparaat)

Hier kunt u de audioberichten van het antwoordapparaat beluisteren, indien beschikbaar en geactiveerd.



















		Bericht van bezoeker		
Nr.1			14-03-2020 10:47:35	
Nr.2			13-03-2020 14:47:39	
Nr.3			13-03-2020 14:26:06	
				

## Opnamelogboeken

Hier vindt u een overzicht van de foto's gesorteerd op dag

		Opnamelogboeken		
14-03				 
				
				
				

## 5.2.1 Menupunt: Oproepinstellingen

<	Oproepinstellingen				
Beltoon	Beltoon 6	>			
Beltoon activeren	<input type="checkbox"/>				
Duur beltoon		30 s			
Duur oproep		30 s			
Oproepomleiding		0 s			
Microfoonvolume		10%			
Beltoonvolume (monitor)		70%			
Gesprekvolume		10%			
Tiktoon	<input type="checkbox"/>				
Automatisch aannemen	<input type="checkbox"/>				
Onmiddellijke automatische acceptatie	<input type="checkbox"/>				
Modus niet storen	Binnenstation	>			
Niet storen	Hele dag	>			

Knop/weergave	Beschrijving
Beltoon (1~6):	Maak een keuze tussen de 6 standaardbeltonen.
Beltoon activeren:	Hier kunt u de beltoon activeren of dempen.
Duur beltoon (1~60s):	Stelt de duur van de beltoon in voor een inkomende oproep. Na de ingestelde tijd wordt de beltoon automatisch gedempt. De oproep blijft actief.
Duur oproep (1~60s):	Bepaalt de duur van de oproep. Na de ingestelde tijd wordt de inkomende oproep automatisch beëindigd.
Oproepomleiding (0~20s):	De oproepomleiding vertraagt het oproepen van de ABUS Link Station App. Voorbeeld: 10

	seconden. Na een oproep gaat de monitor van het deurstation direct over, maar het ABUS LINK Station wordt met een vertraging van 10 seconden opgeroepen.
Microfoonvolume (0~100%):	Stel hier het microfoonvolume van de monitor in. Hoe hoger het percentage, hoe luider (gevoeliger) de microfoon op de monitor is.
Beltoonvolume (monitor) (0~100%):	Stel hier het beltoonvolume van de monitor in.
Gespreksvolume (10~100%):	Stel hier het gewenste gespreksvolume op de monitor in.
Tiktoon:	Activeert het toetsgeluid bij het tikken op het touchscreen van de monitor.
Automatisch aannemen:	Als de functie is geactiveerd, neemt de deurintercom de oproep met het antwoordapparaat na afloop van de beloproep aan (beltijd).
Onmiddellijke automatische acceptatie	Wanneer deze functie wordt geactiveerd, neemt de deurintercom onmiddellijk en automatisch de oproep aan met het antwoordapparaat wanneer er aan de deur wordt gebeld.  Als de functie is uitgeschakeld, zal het antwoordapparaat de oproep automatisch aannemen na de ingestelde oproepduur.
Modus niet storen:	Binnenstation: Oproepen van deurstations en extra beeldschermen zijn toegestaan. Oproepen vanuit andere appartementen zijn niet toegestaan. Om oproepen vanuit appartementen mogelijk te maken, zet u de functie "Niet storen" op "Gedeactiveerd".  Alle: Alle oproepen worden afgewezen. (Oproepen van deurstation, extra monitor of ander appartement)
Niet storen:	Gedeactiveerd, hele dag, tijdschema (dagelijks van tot uur/minuut). Stelt de periode in waarin de functie "Niet storen" actief is.









	<p><b>Firmware-release-opmerking</b></p> <p>Functie: automatisch beantwoorden, direct automatisch beantwoorden  Videomodule (THVS20000 / TVHS20010): V2.2.3_build_201029  Monitor (TVHS20200 / TVHS20210): V2.1.2_build_201029</p>
---	--

Als u een (reeds bestaande) huisbel / deurbel wilt blijven gebruiken, ga dan naar het hoofdstuk "9.5 Bestaande voordeurbel aansluiten" in de sectie Instructies voor installatie- en ingebruikname.

Informatie over het wijzigen van het volume van de videodeurmodule vindt u in het hoofdstuk "9.4 Volume op de deurvideomodule (TVHS20000, TVHS20010) instellen".

In het hoofdstuk "9.9 Eigen beltonen in de monitor van het deurstation laden" leest u hoe u uw eigen beltonen in de monitoren kunt importeren.

### 5.2.2 WLAN-instellingen

	WLAN-instellingen		
			
MAX_VOORBEELDWIFI			
			
			

Knop/weergave	Beschrijving
Activeren/deactiveren	Activeren/deactiveren van de WLAN-interface van de monitor
Lijst met WLAN-netwerken	Hier vindt u de beschikbare WLAN-netwerken in uw omgeving. Bij het selecteren van een item wordt u gevraagd om het WLAN-wachtwoord in te voeren. Na een succesvolle verbinding verschijnt er een groen bevestigingsvinkje in de lijst voor het geselecteerde netwerk.
WLAN Info-icon	Hier ziet u de WLAN-parameters zoals de netwerknaam, het signaalniveau en de IP-parameters.  Wanneer u op "VERBREKEN" klikt, wordt de monitor losgekoppeld van het WLAN-netwerk.

### 5.2.3 Etagebeldrukker

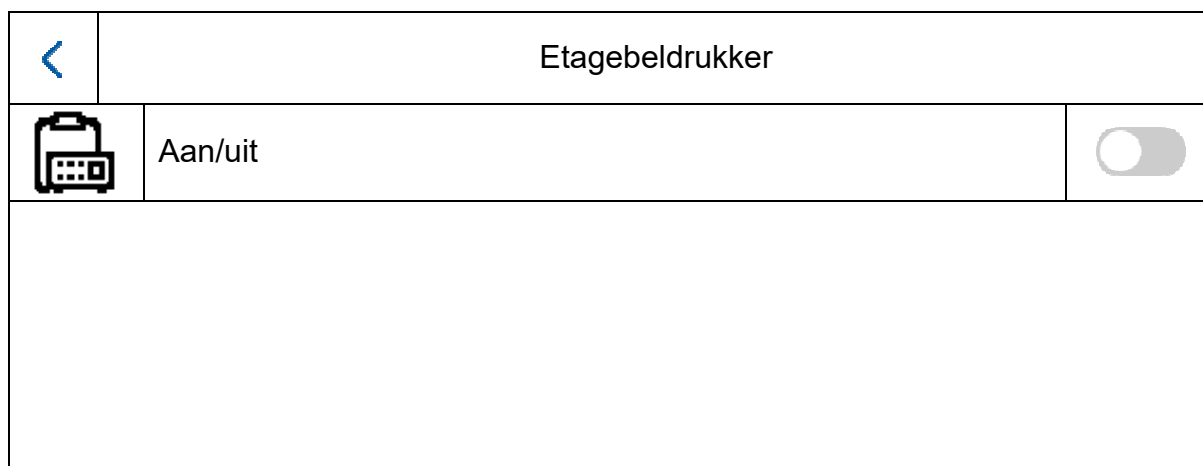







De etagebeldrukker wordt rechtstreeks op de monitor aangesloten via de bedrade ingangen en zorgt voor een directe bel bij de appartementsdeur. Deze functie wordt vooral gebruikt in appartementsgebouwen. Hier is het hoofddeurstation onderin bij de hoofdingang geïnstalleerd. Elk appartement heeft echter een directe beldrukker bij de deur van het appartement. De beltoon van de etagebeldrukker verschilt van de normale beltoon van de videodeurmodule.

Knop/weergave	Beschrijving
Lijn 1 – lijn 8	Beschrijft welke ingang op de monitor wordt gebruikt voor de etagebeldrukker. Meestal wordt ingang 1 (lijn 1) gebruikt.
NO / NC	Normally Open / Normally Closed. Hier kunt u bepalen of de beldrukker van de appartementsdeur een verbreek- of een maakcontact is. Meestal is het een "NO"-contactschakelaar.

Meer informatie vindt u in de sectie Instructies voor installatie- en ingebruikname in hoofdstuk "9.7 Etagebeldrukker op de hoofdmonitor aansluiten".

## 5.2.4 Overige instellingen

### 5.2.4.1 Configuratie – Lokale informatie

<	Lokale informatie			
Appartementnr.			1	
Duur livebeeld		30 s		
Instellingen ABUS Link Station-service			>	
Tijd synchroniseren			>	
Zomertijd			>	
Wizard			>	

Dit gedeelte is beveiligd met een wachtwoord. Voer het wachtwoord van de eerste installatie in.

**Aanwijzing:** Bij het installatietype "extra binnenmonitor" zijn de volgende menupunten niet beschikbaar op de monitor. **Deze kunnen alleen op de hoofdmonitor van het systeem worden ingesteld/opgeroepen:**

- "Automatisch aannemen" van het antwoordapparaat in-/uitschakelen.
- Berichten op antwoordapparaat beluisteren
- ABUS LINK station app – menu
- Netwerkkamera's toevoegen
- Configuratie netwerkadres en reset fabrieksinstellingen op de randapparaten

Installatietype: Keuzemogelijkheden: Binnenstation, extra binnenmonitor

**Binnenstation:** Hoofdmonitor van de deurintercom in een woning/appartement

**Extra binnenmonitor:** max. 5 extra monitoren kunnen worden aangesloten binnen een woning/appartement

Voorbeeld: Videomodule + binnenstation + 5 extra binnenmonitoren

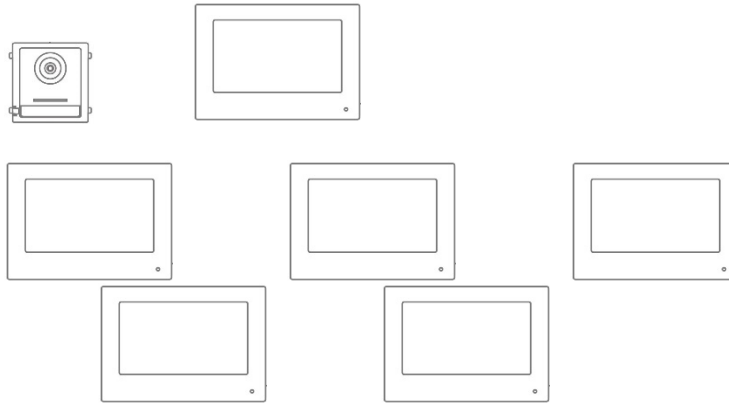

Appartementnr.: Dit is het maximale aantal extra binnenstation-monitoren dat via een deurvideomodule met 8 extra beldrukkers kan worden aangesloten. Dit maximum aantal is 49 binnenstation-monitoren of 49 woningen/appartementen.



Alleen bij instelling "*Extra binnenmonitor*":

Nr. (1~5): Nummerconfiguratie van de extra binnenmonitor. Er zijn maximaal 5 extra monitoren mogelijk.

Ruimtenaam: Naam van de ruimte waar de extra monitor zich bevindt.

Duur livebeeld (10~60s): Afspeelduur van het handmatig opgevraagde livebeeld van een deurvideomodule of een aangesloten IP-camera. (toegankelijk via hoofdpagina / livebeeld)

Informatie over het installeren van meer beldrukkers in een meergezinswoning vindt u in de sectie Instructies voor installatie- en ingebruikname in hoofdstuk "9.3 Extra beldrukkers (TVHS20020) voor een meergezinswoning instellen".

### **Instellingen ABUS Link Station-service:**

De ABUS Link-Station-functie wordt gebruikt om eenvoudig een smartphone-app in te stellen en aan te sluiten op het deurintercomsysteem. Hiervoor zijn slechts enkele stappen nodig. Hiervoor moet het deurstation een actieve internetverbinding hebben.

Dit menu is alleen beschikbaar op een monitor met de instelling "Binnenstation" (hoofdmonitor).

Activeer deze functie als u wilt dat u via de app toegang krijgt tot de deurintercom.

#### **Werkwijze:**

1. Installeer de ABUS Link Station APP (lite/pro) (Android/iOS)
2. Tik in de app op "Apparaat toevoegen" of "QR-code scannen".
3. Scan de QR-code die wordt weergegeven op de instelpagina van ABUS Link Station. Elke binnenstation-monitor heeft zijn eigen QR-code.
4. Tijdens het installatieproces moet de verificatiecode worden ingevoerd. Ook deze wordt getoond op de instelpagina en kan naar wens worden gewijzigd.

Een QR-code kan alleen worden toegevoegd aan een ABUS Link Station-account. Extra

accounts kunnen door middel van een vrijgave toegang krijgen tot het deurintercomsysteem.

Instellingen ABUS Link Station-service	
ABUS Link Station-service activeren	
Verificatiecode	xxxxx
ABUS Link Station-serverstatus	Verbonden
	

Tijd synchroniseren:







Tijdstelling via het NTP-protocol activeren.

Het interval bepaalt de updatefrequentie in minuten.

In het veld IP-adres kunt u een NTP-serveradres of IP-adres invoeren.

Het poortnummer ligt vast op 123 (standaardpoort voor het NTP-protocol).

Selecteer de tijdzone waarin de deurintercom zich bevindt (meestal GMT+01:00)

Tijd synchroniseren		
 NTP activeren		
Interval synchroniseren	60	
IP-adres	ntp.org	
Poortnr.	123	
Tijdzone	(GMT+1:00 Amsterdam, Berlijn, Rome, Parijs) 	
		



	<p>Bij gebruik van de ABUS Link Station-service in combinatie met de push-functie voor een beloproep, moet de NTP-functie geactiveerd en correct geconfigureerd zijn.</p> <p>Zorg ervoor dat u het juiste NTP-serveradres "0.pool.ntp.org" gebruikt.</p>
---	--

Zomertijd: Invoeren van de details voor de datum waarop tussen zomer- en naar wintertijd wordt gewisseld.







	Zomertijd		
	Zomertijd activeren		
Starttijd	Zondag laatste week van maart 2:00		
Eindtijd	Zondag laatste week van oktober 3:00		
Verschuiving	60min		
			

Wizard: Installatiewizard opnieuw starten. De volgende stappen worden uitgevoerd binnen de wizard:

- a) Taalinstelling
- b) Netwerkinstelling (draadgebonden interface)
- c) Installatietype of werkwijze van de monitor (binnenstation of extra binnenmonitor) en appartementnummer
- d) Aansluiting van het apparaat op de monitor.
  - Indien binnenstation-> toewijzing van een deurvideomodule
  - Indien extra monitor -> toewijzing van de hoofdmonitor (binnenstation)







### 5.2.4.2 Configuratie – Netwerkinstellingen

Dit menu betreft de instellingen voor de draadgebonden

Netwerkinstellingen		
 DHCP		
Lokale IP	192.168.0.11	
Subnetmasker	255.255.255.0	
Gateway	192.168.0.1	
DNS-adres	192.168.0.1	
DNS-adres 2	194.25.2.129	

Knop/weergave	Beschrijving
DHCP	DHCP in-/uitschakelen. Het wordt sterk aanbevolen om alle componenten van de deurintercom op een vaste IP in te stellen.
Lokale IP	Stel hier de lokale IP van het apparaat in
Subnetmasker	Stel hier het subnetmasker van het apparaat in
Gateway	Stel hier de gateway van het apparaat in. Meestal wordt hier de IP van de router gebruikt.
DNS-adres	Stel hier het DNS-adres van het apparaat in. Meestal wordt hier de IP van de router gebruikt.
DNS-adres 2	Stel hier het alternatieve DNS-adres voor het apparaat in. Meestal wordt hier de IP van de router gebruikt.

### 5.2.4.3 Configuratie – Apparaatbeheer

	Apparaatbeheer		
Hoofddeurstation	192.168.0.26		
			
			
			

De functie van dit menu verschilt wezenlijk tussen binnenstation en extra binnenmonitor. Hier kunt u de toewijzingen van de apparaten aan elkaar aanpassen.

#### Let op:

De hoofdmonitor van een systeem moet altijd gekoppeld zijn aan de hoofdvideomodule. Een extra monitor van een systeem moet altijd worden gekoppeld aan de hoofdmonitor van het systeem.







Binnenstation:           - Toewijzing aan het hoofddeurstation  
                                  - Meer IP-netwerkcamera's toevoegen voor een liveweergave. Klik hiervoor op het "+" symbool rechtsboven en selecteer "Private Protocol" voor een ABUS-netwerkcamera.

Extra binnenmonitor:   - Toewijzing van het binnenstation (hoofdmonitor)

In dit menu kunnen de volgende extra interacties worden uitgevoerd:

- Instellen van de netwerkparameters (DHCP, IP-adres etc.) van de deurstations
- De deurstations resetten naar de fabrieksinstellingen

### Instellen van de netwerkparameters van de videodeurmodule

Deurstation instellingen	
192.168.0.26	
255.255.255.0	
192.168.0.1	
DHCP	<input type="checkbox"/>
Microfoonvolume	 70% 
Beltoonvolume	 70% 
Belvolume	 70% 
Afbreken	OK

**Regels 1-3:**

**DHCP:**

IP-adres, gateway en subnetmasker wanneer de knop wordt ingedrukt, wordt het verzoek om de IP-adresgegevens van de DHCP-server gestart. De schakelaar gaat dan terug naar links. De ontvangen IP-adresgegevens worden dan als vaste gegevens ingesteld. Er is geen verdere automatische opvraging van de gegevens.

**Microfoonvolume:**

**Beltoonvolume:**

de gevoeligheid van de microfoon in de videodeurmodule instellen  
Instelling van het volume van de beltoon na het indrukken van de belknop op de videodeurmodule

**Oproepvolume:**

Instelling van het volume tijdens een oproep op de videodeurmodule

### Een reset uitvoeren naar de fabrieksinstellingen van de videodeurmodule

Alle instellingen van de videodeurmodule kunnen hier via de hoofdmonitor worden gereset.

Alle standaardparameters herstellen?	
Afbreken	OK

## ABUS netwerkcamera toevoegen

Om een ABUS-netwerkcamera aan het systeem toe te voegen, klikt u op het "+"-symbool in de rechterbovenhoek onder "Apparaat toevoegen".

Selecteer "Private Protocol" voor ABUS-camera's en wijs een willekeurige apparaatnaam toe. Daarnaast is het IP-adres van de camera in het netwerk en de RTSP-poort (standaard 554) nodig voor de integratie. Tot slot moet u de gebruikersnaam en het wachtwoord van uw netwerkcamera invoeren.









De lijst van compatibele ABUS-netwerkcamera's vindt u op [www.abus.com](http://www.abus.com).

### 5.2.4.4 Configuratie – Standaardinstellingen

**Standaardinstellingen:** Reset de monitor naar de fabrieksinstellingen. De activering / het wachtwoord blijft behouden.

**Fabrieksinstellingen:** Reset de monitor incl. wachtwoord naar de fabrieksinstellingen. Daarna staat de monitor in de "inactieve" toestand.

### 5.2.4 Relaisconfiguratie

<		Relaisconfiguratie		
	Relais 1			
Duur			3s	
Interval			5s	
	Relais 2			

Onder "Relaisconfiguratie" worden de twee relais van de monitor zelf geconfigureerd. De configuratie in dit menu heeft geen invloed op de relais van de videodeurmodule.

De relaisuitgangen bevinden zich aan de achterzijde van de monitor en kunnen worden aangesloten met de bijgeleverde kabel aansluiting. De toewijzing is afgedrukt op de achterkant van de monitor.

Het **relais 1** wordt geschakeld tussen COM1 en NO1, het **relais 2** wordt verbonden met COM2 en NO2.

Knop/weergave	Beschrijving
Relais 1	Activeert / deactiveert de functie van een extra (of een reeds bestaande) huisbel. Relais 1 op de monitor wordt parallel aan een oproep getriggerd.
Duur	Bepaalt hoe lang het relais voor de extra deurbel wordt geactiveerd als er wordt gebeld.

Interval	Definieert het interval waarmee het relais de extra deurbel activeert voor de ingestelde "duur" wanneer een deurbel wordt ontvangen.
Relais 2	Activeert / deactiveert de extra schakeluitgang op de monitor (bijv. voor een deuropener op de woningdeur op de betreffende verdieping). Wanneer de functie is geactiveerd, verschijnt er een ander "sleutelsymbool" met de aanduiding "3" op de lokale monitor.

Voor meer informatie leest u het hoofdstuk "9.6 Bestaande deuropeners op de monitor van deurstation aansluiten" en "9.5 Bestaande voordeurbel aansluiten" in de sectie Instructies voor installatie- en ingebruikname.

U vindt hier ook informatie over het volgende onderwerp: "9.8 Elektrische deuropener op videomodule (incl. "tuindeur") aansluiten"

### 5.2.5 *microSD-kaart*

Knop/weergave	Beschrijving
Formatteren	<b>Let op!</b> De hele microSD-kaart wordt geformatteerd en alle gegevens op de kaart worden gewist.
De-installeren	Deactiveert de microSD-kaart, er wordt niet meer opgenomen. U kunt de microSD-kaart gemakkelijk verwijderen.

### 5.2.6 *Scherm vergrendelen*

Vergrendelt het scherm gedurende 30 seconden. Gedurende deze tijd is het touchpaneel gedeactiveerd en kan het bijvoorbeeld worden gereinigd.

### 5.2.7 *Apparaatgegevens*

Hier vindt u de firmwareversie van de monitor en het model- en serienummer van uw apparaat. Voor de update-instructies verwijzen wij u naar het hoofdstuk "ABUS CMS-software": firmware-update" in de sectie Instructies voor installatie- en ingebruikname.

### 5.2.8 *Tijd instellen*

Hier kunt u handmatig de tijd/datum van de monitor instellen. Als alternatief kunt u ook direct op de tijd in het hoofdscherm klikken.

### 5.2.9 *Apparaat opnieuw opstarten*

Start de monitor opnieuw op.

## 5.2.10 Wachtwoordinstellingen (PINCODE)

### Pincode-toewijzing voor toetsenbord TVHS20030

	Wachtwoordinstellingen	
Pincode		
		

Aanwijzing: Hiervoor heeft u het toetsenbord voor het invoeren van de pincode in de TVHS20030 nodig.

Hier kunt u een 6-cijferige code instellen, die vervolgens geldig is voor het openen van de deur via het toetsenbord. De pincode bestaat altijd uit 6 cijfers.

Om de pincode op het toetsenbord in te voeren, drukt u op de volgende combinatie:

Tot firmware V2.0.8 / V2.1.2 build 200410:

"#" 6-cijferige pincode "#". Voorbeeld: # 123456 #

Vanaf firmware V2.2.3 / V2.1.2 build 201029:

"#" 6-cijferige pincode van appartement "#". Voorbeeld: # 1123456 #

- d.w.z. vanaf deze firmware kan de pincode voor elk appartement afzonderlijk worden ingesteld.
- Het is nu mogelijk om appartementafhankelijke pincodes te wijzigen en te wissen

Een pincode kan **lokaal** op de monitor worden toegewezen. **Via** de remote-configuratie van de ABUS CMS-software kunnen drie extra codes worden ingevoerd. In totaal zijn er 4 verschillende pincodes beschikbaar. Om een code toe te voegen via ABUS CMS-software, opent u de externe configuratie van de deurvideomodule en selecteert u het menupunt "Intercom" en "Permission password". De pincodes worden over het algemeen opgeslagen in de videomodule en niet in het toetsenbord.

## Remote Configuration

The screenshot displays the 'Remote Configuration' interface. On the left is a navigation menu with categories: System (Device Information, General, Time, System Maintenance, User, RS485), Intercom (ID Configuration, Time Parameters), Permission Password (selected), and Access and Elevator Control. The main content area is titled 'Configuring the Right and Password Parameters' and contains the 'Permission Password' section. This section includes a 'Password Type' dropdown menu set to 'PublicPassword1', and three input fields for 'Old Password', 'New Password', and 'Confirm Password'. A 'Save' button is located below the input fields.

### 5.2.11 *Systeemtaal*

Selecteer de gewenste taal.

### 5.2.12 *Helderheidsinstelling*

Hier kunt u de helderheid van de monitor in het bereik van 0 - 100 % instellen.

### 5.2.13 *Etagebeldrukker*

Activeert / deactiveert de functie van de etagebeldrukker. Wanneer de functie is geactiveerd, verschijnt aan de rechterkant onder het "WLAN"-symbool een ander menupunt. De etagebeldrukker-functie is nu beschikbaar en kan worden gebruikt via de bedrade ingangen van de monitor. Meer uitleg vindt u onder "9.7 Etagebeldrukker op de hoofdmonitor aansluiten" in de sectie Instructies voor installatie- en ingebruikname

### 5.2.14 *Open Source licentie-informatie*

Lees de informatie over de open source-licentie aan het einde van dit document.



## 6. Onderhoud en reiniging

### 6.1 *Funcietest*

Controleer regelmatig de technische veiligheid van het product, bijvoorbeeld beschadiging van de behuizing.

Als aangenomen moet worden dat een veilig gebruik niet meer mogelijk is, moet het product buiten werking gesteld worden en beveiligd worden tegen onbedoeld gebruik. Er moet worden aangenomen dat een veilig gebruik niet meer mogelijk is, als

- het apparaat zichtbare beschadigingen heeft
- het apparaat niet meer functioneert
- na opslag onder ongunstige omstandigheden
- het apparaat tijdens transport onderhevig was aan belastingen



#### **Neem het volgende in acht:**

Het product is voor u onderhoudsvrij. In het product bevinden zich geen onderdelen die gecontroleerd of onderhouden moeten worden – open het dus nooit.

### 6.2 *Reiniging*

Reinig het product met een schone, droge doek. Bij sterkere vervuiling kan de doek met een beetje lauw water bevochtigd worden.



Zorg ervoor dat er geen vloeistoffen in het apparaat binnendringen, omdat het apparaat hierdoor vernield wordt. Gebruik geen chemische reinigingsmiddelen, omdat dit het oppervlak van de behuizing kan beschadigen.

## 7. Afdanken



Apparaten die zo gemarkeerd zijn, mogen niet met het gewone huisvuil meegegeven worden. Voer het product aan het einde van de levensduur af volgens de geldende wettelijke bepalingen. Neem contact op met uw distributeur of breng de producten naar het gemeentelijke verzamelpunt voor elektrisch afval.

## 8. Open Source licentie-informatie

Het product bevat softwarecomponenten die door de rechthebbenden in licentie zijn gegeven als gratis software of open source software (hierna "OSS" genoemd). De bijbehorende licenties zijn in gedrukte vorm bij het product gevoegd en / of zijn toegankelijk via een grafische gebruikersinterface. U kunt gebruiksrechten, voor zover daar geregeld, rechtstreeks van de rechthebbenden verwerven. De open source-licenties hebben voorrang op alle andere licentievoorwaarden en contractuele overeenkomsten met ABUS met betrekking tot de overeenkomstige OSS-softwarecomponenten in het product. Licentie-informatie over ABUS-producten vindt u in het algemeen op [www.abus.com](http://www.abus.com) in het downloadgedeelte van de productbeschrijving.

## 9. Instructies voor installatie- en ingebruikname

### 9.1 Veiligheidsmodule gebruiken (TVHS10040/TVHS20340)

De veiligheidsmodule TVHS10040 (of nieuw artikelnummer TVHS20340) wordt gebruikt om het deuropenercontact te verplaatsen naar de beveiligde binnenruimte en zo te beschermen tegen sabotage. De veiligheidsmodule wordt met 12V spanning geleverd en via RS485-BUS met de deurvideomodule verbonden.

Gebruik de bij de deurvideomodule meegeleverde 4-pins kabel. Deze kabel moet aan één kant van de connector worden losgekoppeld en de kabels moeten worden aangesloten op de veiligheidsmodule. De ID DIP-schakelaars op de veiligheidsmodule zijn hier niet nodig en blijven op hun standaardwaarden ingesteld. (DIP-schakelaar 1 aan, DIP-schakelaar 2/3/4 uit)

De veiligheidsmodule TVHS10040 moet nog worden geconfigureerd als een nieuw deurrelais. Open hiervoor de remote configuratie van de deurvideomodule met de ABUS CMS software en ga naar het menu "Intercom" / "IO In Out" en zet "IO Out" voor "DOOR 1" op "securityModule"

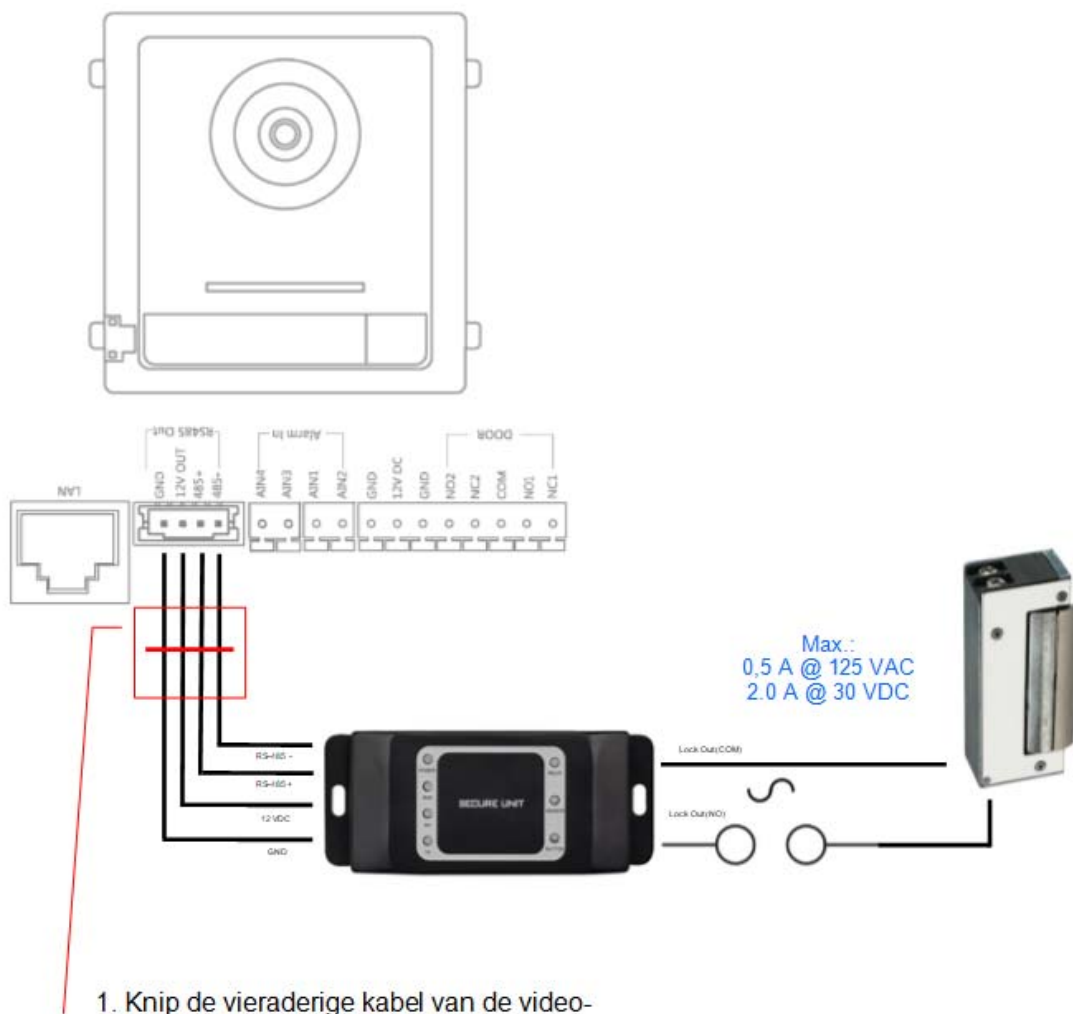

1. Knip de vieraderige kabel van de video-deurmodule af (leveringsomvang)

2. Sluit de 4 draden met de volgende kleur aan op de veiligheidsmodule.



Tot firmware V2.0.8 / V2.1.2 build 200410:

De beveiligingsmodule moet nog geconfigureerd worden als nieuw deurrelais. Open hiervoor de configuratie op afstand van de deurvideomodule met de ABUS CMS-software en ga naar het menu "Intercom" / "IO In Out" en stel "IO Out" voor "DOOR 1" in op "securityModule"

Vanaf firmware V2.2.3 / V2.1.2 build 201029:

Na het aansluiten van de veiligheidsmodule wordt deze automatisch herkend.

Nu wordt tijdens het openen van de deur niet meer het interne relais van de deurvideo-intercommodule aangestuurd, maar het relais van de veiligheidsmodule. Terwijl het relais actief is, brandt de groene LED "Relay" op de TVHS10040.

**Let op:** Per videodeurmodule kan slechts één TVHS10040-veiligheidsmodule worden gebruikt!

**Aanwijzing:** De veiligheidsmodule wordt altijd als laatste module aangesloten. Het maakt niet uit of er slechts één videodeurmodule of uitbreidingsmodules zijn aangesloten.

Belastbaarheid van het relais: max. 2A 30VDC / 0.5A 125AC

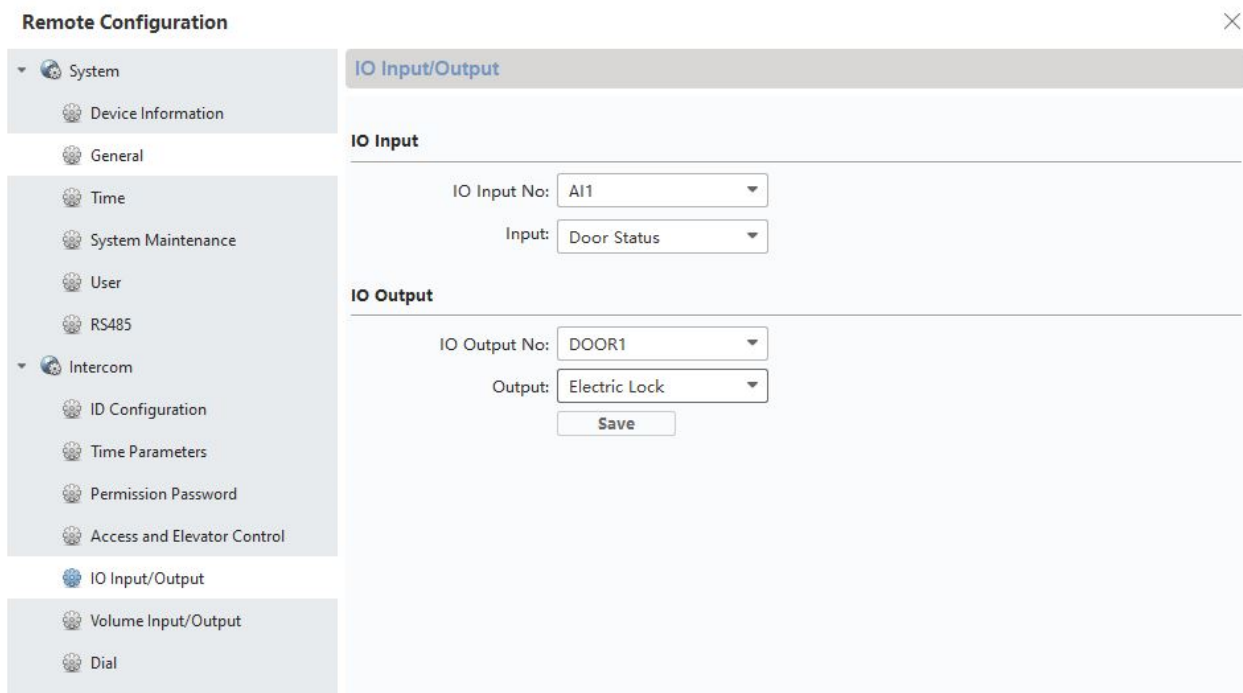

## 9.2 Neveningen installeren

Als u een extra deurvideomodule (maximaal 16) in het systeem wilt integreren om een neveningang te realiseren (bijv: goederenontvangst, kelderdeur etc) neemt u de volgende stappen:

- 1) Sluit de deurvideomodule van de neveningang aan op het netwerk van de hoofddeurintercom. Alle apparaten van het deurintercomstation moeten zich in het fysieke LAN bevinden.
- 2) Open de ABUS CMS-software en activeer de deurmodule van de neveningang.
- 3) Voeg de deurintercommodule van de neveningang toe aan de ABUS CMS-software en open de configuratie op afstand.
- 4) Onder "Intercom" verandert u nu in het "Room Number". Onder " No.:" wordt het nummer van de neveningang ingevoerd. De hoofddeur-videomodule moet het nummer "0" hebben. De extra neveningen zijn genummerd van 1 tot 9. Verander de nummers van "Period/Building/Unit of Floor" niet.

Na het opslaan wordt het systeem opnieuw opgestart. Bevestig dit met "OK".

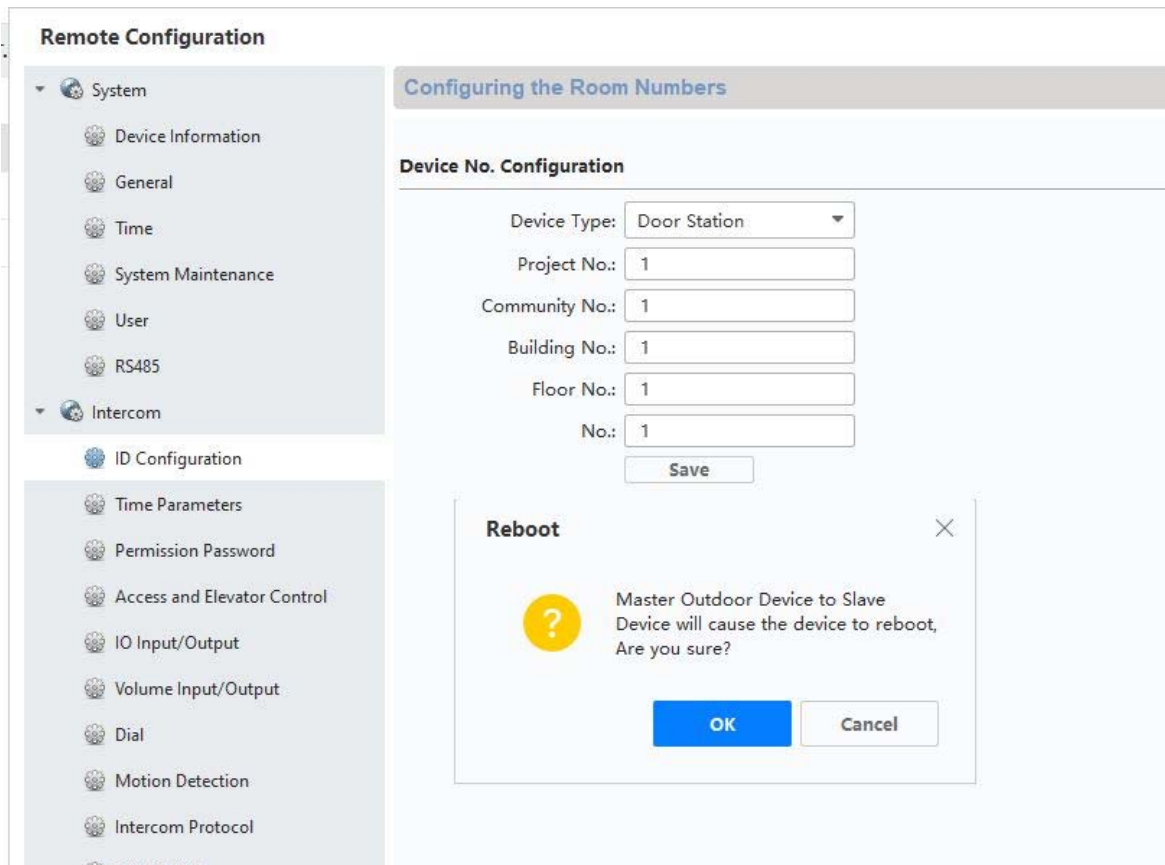

- 5) Na een succesvolle herstart moet u de hoofddeur aan de neveningang toewijzen. Hiervoor onder "Network" / "NetConfig SIP" onder "(Main)Outdoor IP Address" het IP-adres van het hoofddeurstation invullen en opslaan.

**Let op:** Het menu "(Main) Outdoor IP Adress" verschijnt alleen als u stap 4) correct heeft uitgevoerd.

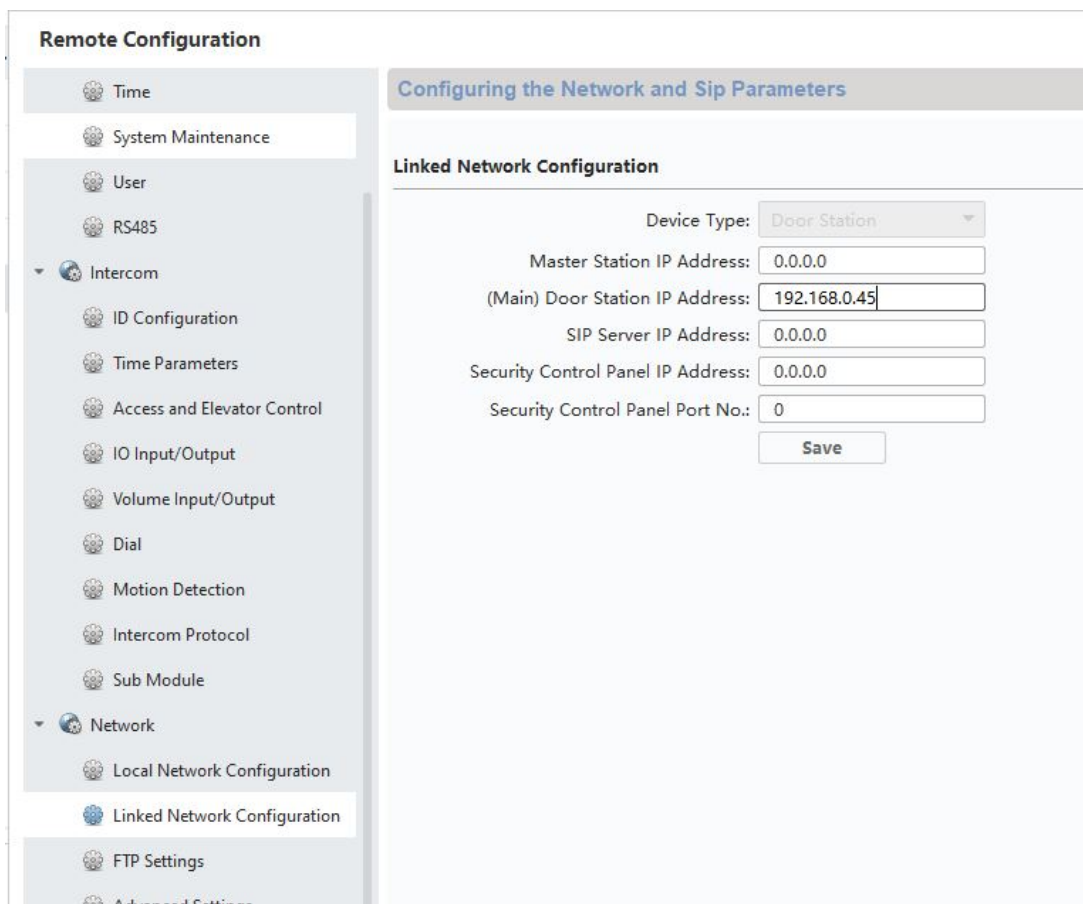

- 6) De installatie van een neveningang is nu voltooid. Als er nu wordt gebeld bij de neveningang, laat de monitor ook zien dat de oproep is gestart vanaf een neveningang. Onder "LIVEBEELD" op de monitor is nu het videobeeld van de neveningang direct toegankelijk en kan de deur worden geopend.

### 9.3 Extra beldrukkers (TVHS20020) voor een meergezinswoning instellen

Tot 49 beldrukkers voor meergezinswoningen kunnen via de extra optionele modules (TVHS20020) worden gerealiseerd. De uitbreidingsmodule wordt via een verbindingkabel met de hoofdvideomodule verbonden.

Als er slechts één extra beldrukkermodule wordt gebruikt, kan de installatie worden uitgevoerd zonder de ABUS CMS-software.

De hoofddeurmodule is de bel met het "appartementnummer 1". De uitbreidingsmodule TVHS20020 wordt automatisch ingesteld op appartementnummer 2 – 7. Het "appartement" komt hier overeen met een afzonderlijk appartement.

Als u de beldrukker van de hoofdvideomodule niet gebruikt en deze afsluit met de afdekplaat, moet u de uitbreidingsmodule TVHS20020 configureren via de ABUS CMS-software. Onder "Intercom" / "Submodule" vindt u alle uitbreidingsmodules die op de RS-485 BUS zijn aangesloten. (Uitzondering: De veiligheidsmodule TVHS10040 verschijnt hier niet)

Klik in het menu "Submode" op het "Settings"-symbool om de appartementnummers toe te wijzen.

De submodule-ID is afhankelijk van de ID die via DIP-schakelaars aan de achterzijde van de uitbreidingsmodules is ingesteld. Dit maakt het eenvoudig om de juiste toe te wijzen voor een structuur met meerdere uitbreidingsmodules.

**Let op:** Na het wijzigen van de ID via de DIP-schakelaar moet de betreffende uitbreidingsmodule kortstondig van de kabel worden losgekoppeld en opnieuw worden opgestart.

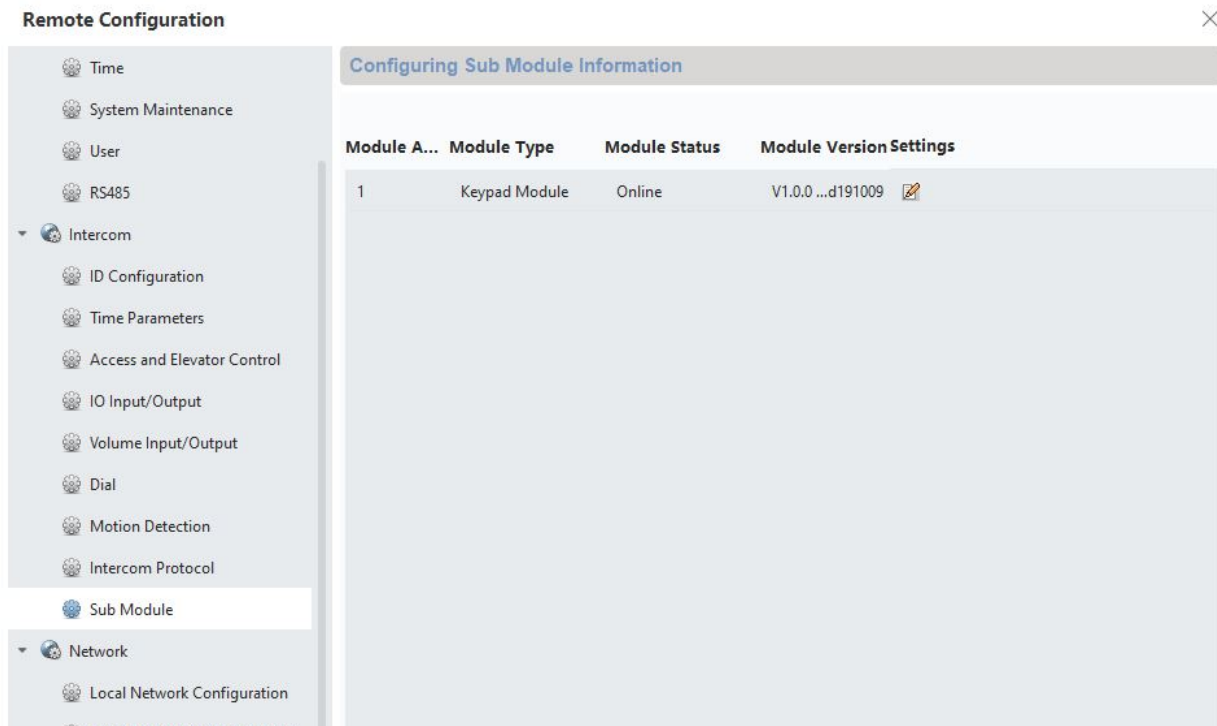

The screenshot displays the 'Remote Configuration' window with a sidebar on the left and a main content area on the right. The sidebar lists various configuration categories, with 'Sub Module' selected under the 'Intercom' section. The main content area is titled 'Configuring Sub Module Information' and contains a table with the following data:

Module A...	Module Type	Module Status	Module Version Settings
1	Keypad Module	Online	V1.0.0 ...d191009 

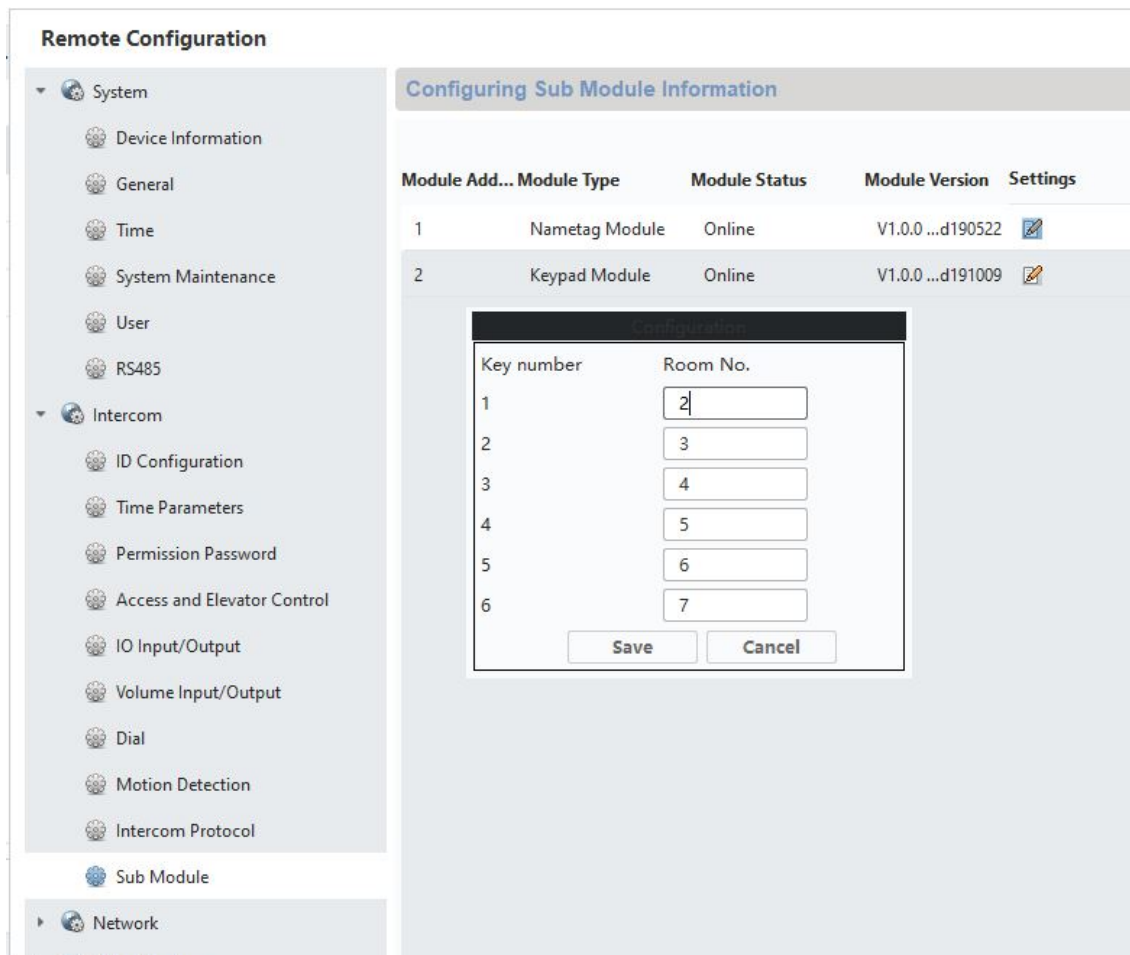

Configuratie van het appartementnummer/woningnummer op de monitor:

Om de beldrukkers van de appartementen aan de juiste monitoren toe te wijzen, moeten de appartementnummer van de monitoren overeenkomen met de nummers van de beldrukkers.

Het appartementnummer van de betreffende monitor wordt weergegeven in het hoofdoverzicht van de monitor.

U kunt het nummer direct in de configuratie op de monitor wijzigen (Configuratie/ Appartementnr.) of toegang verkrijgen tot de betreffende monitor met behulp van ABUS CMS-software en het appartement/woningnummer onder "room.No.:" in het menu "Intercom"/Room Number" wijzigen.

Voorbeeld voor de afdekking van de belknop op de videodeurmodule



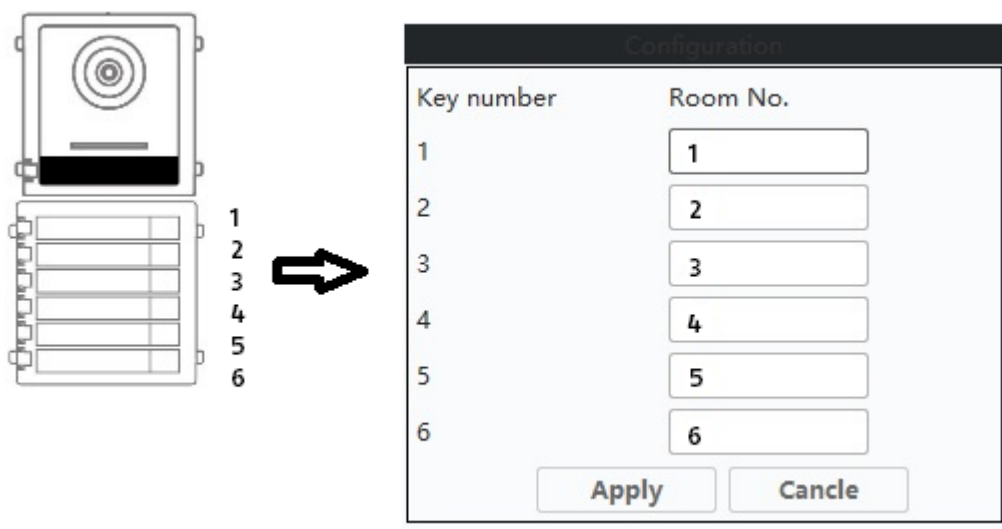

#### 9.4 Volume op de deurvideomodule (TVHS20000, TVHS20010) instellen

De ABUS CMS-software kan worden gebruikt om de microfoongevoeligheid en het gespreksvolume op de deurvideomodule in te stellen. U kunt ook de bevestigingstonen / oproepkiestonen / bezettoonvolume instellen of alles deactiveren.

Knop/weergave	Beschrijving
Volume In	Regelt de microfoongevoeligheid van de deurvideomodule. Hoe hoger de waarde, des te luider wordt de spraak naar de monitor gestuurd.
Volume Out	Regelt de automatische spraakuitvoer (bijv: Laat een bericht achter, gesprek mislukt, enz. Met deze schuifregelaar kan ook het volume van de bevestigingstonen / oproepkiestonen en bezettoon worden ingesteld. (Bij 0 is het volledig stil)
Talk Volume	Hier wordt het spraakvolume ingesteld. Hoe hoger de waarde, des te luider wordt de spraak van de monitor naar het deurstation gestuurd.

## Remote Configuration

The screenshot displays the 'Remote Configuration' interface. On the left is a navigation menu with categories: System (Device Information, General, Time, System Maintenance, User, RS485) and Intercom (ID Configuration, Time Parameters, Permission Password, Access and Elevator Control, IO Input/Output, Volume Input/Output, Dial, Motion Detection, Intercom Protocol). The 'Volume Input/Output' option is selected. The main panel is titled 'Configuring the Volume Input or Output' and contains three sliders: 'Volume Input' (set to 7), 'Volume Output' (set to 7), and 'Talk Volume' (set to 7). A 'Save' button is located at the bottom right of the main panel.

### 9.5 Bestaande voordeurbel aansluiten

Als u al een bestaande voordeurbel heeft, kan deze worden aangesloten op relaisuitgang 1 (COM / NO I) van de monitor. Het relais mag worden belast met max. 2A @ 30VDC of 0,5A @ 125AC.

In het geval van een belsignaal wordt het relais dan op het gewenste interval en de gewenste duur geschakeld. De configuratie van "Relais 1" vindt u in het menu van de monitor onder "Relaisconfiguratie".

Het relais en de lokale beltoon op de monitor worden geactiveerd zolang de "Beltoonduur" in het menu "Oproepinstellingen" is ingesteld.

Als u alleen het belsignaal van uw externe huisgong wilt horen, kunt u de beltoon op de monitor eenvoudig activeren of deactiveren in het menu "Oproepinstellingen" in het menu "Beltoon activeren".

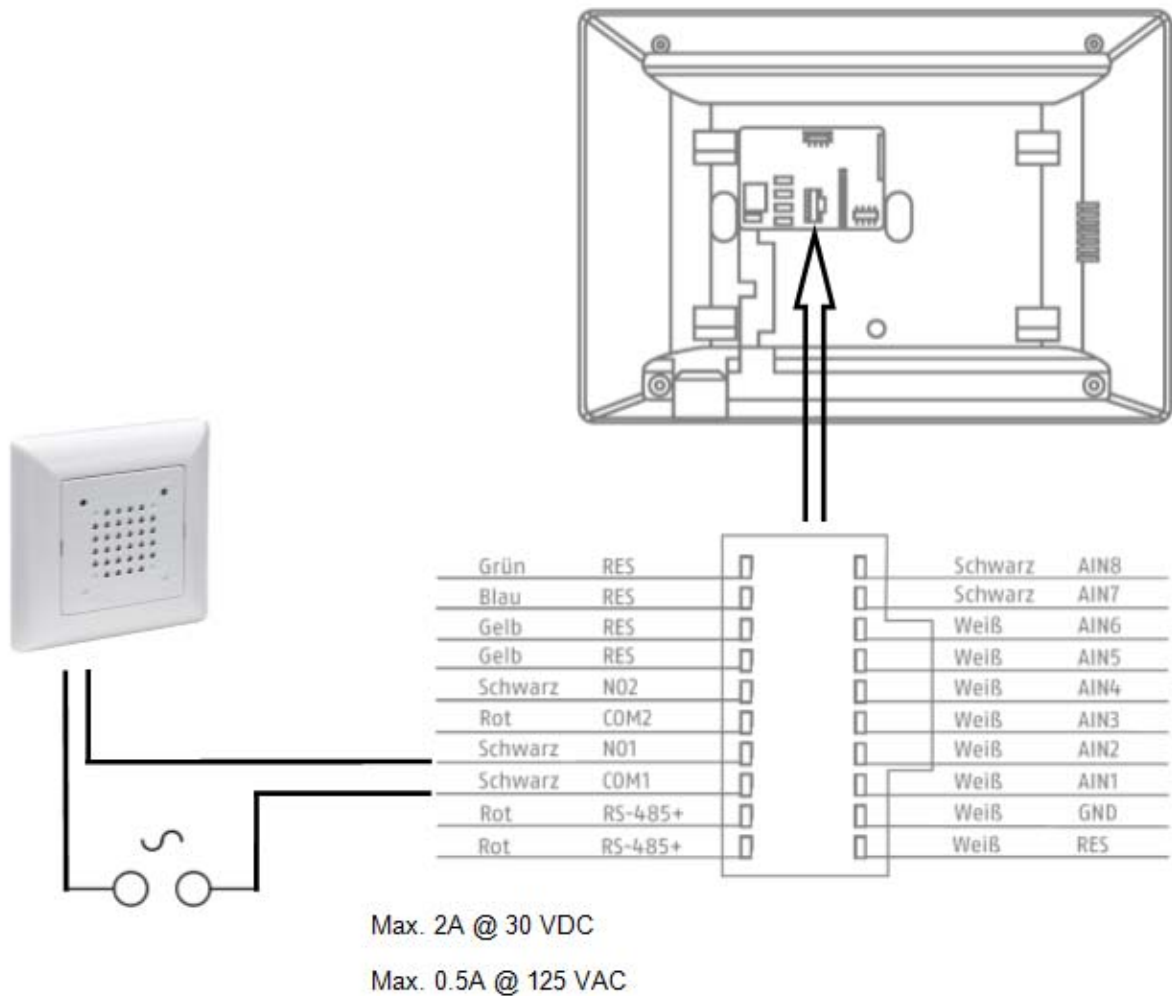

### 9.6 Bestaande deuropeners op de monitor van deurstation aansluiten

Om een appartementsdeur afzonderlijk van een hoofdingang te openen, biedt de monitor de mogelijkheid om een andere deur via een relaisuitgang (relais 2) aan te sturen. Het relais mag max. 2A 30VDC / 0,5A 125AC worden belast.

Om het relais op de monitor te gebruiken, moet u eerst "relais 2" in het menu van de monitor onder "Relaisconfiguratie" activeren. De monitor geeft nu een ander "sleutel"-symbool weer met een "3" als identificatie. De identificatienummers "1" en "2" zijn gereserveerd voor de relais van de deurvideomodule.

Het relais "3" op de monitor kan alleen rechtstreeks via de monitor worden geschakeld, niet via de ABUS LINK STATION App.

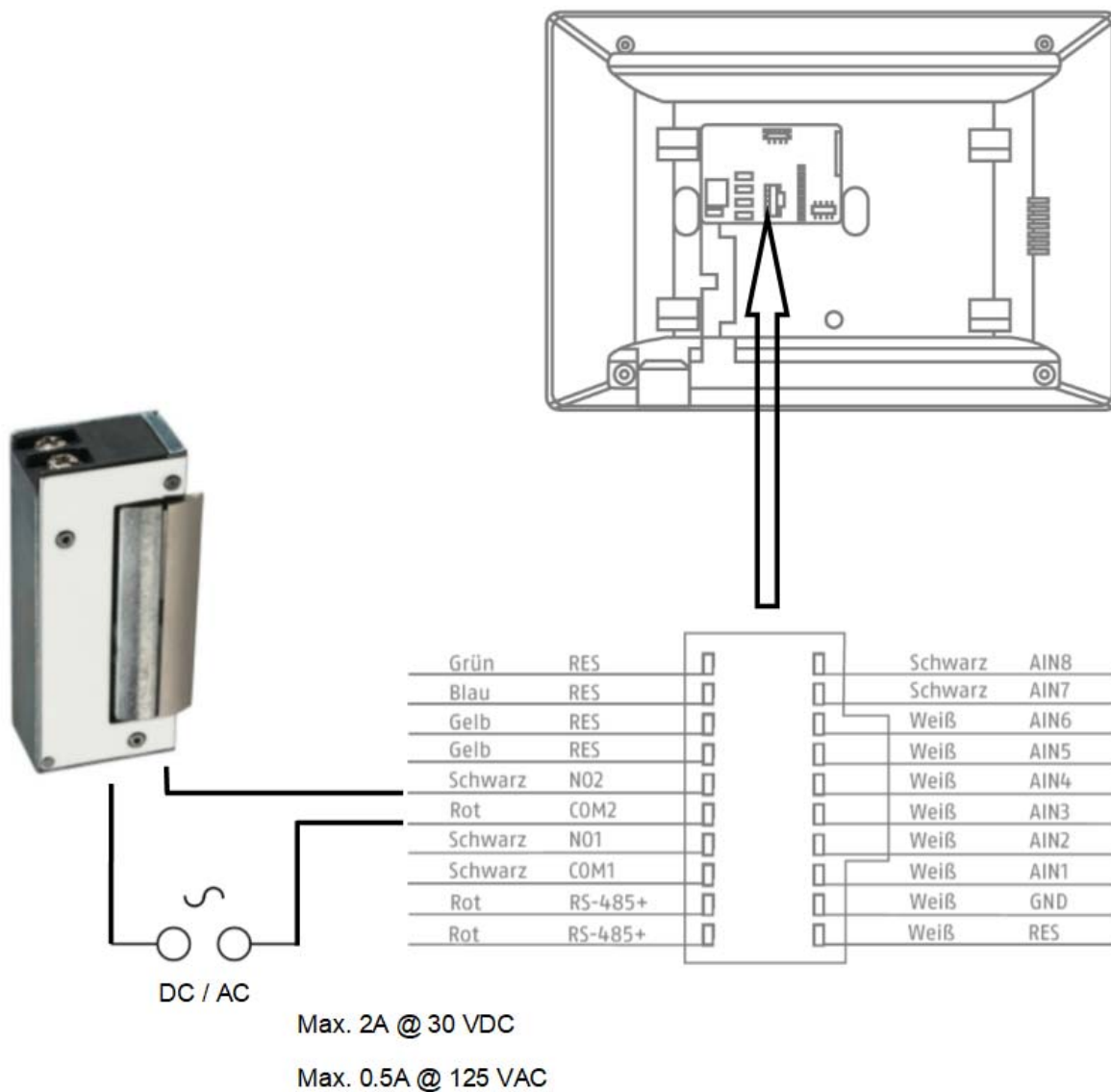

### 9.7 Etagebeldrukker op de hoofdmonitor aansluiten

De etagebeldrukker (beldrukker direct bij de appartementsdeur in een meergezinswoning) kan direct op de monitor worden aangesloten. Direct verbonden met de alarmingang 1 kan de monitor een belsignaal afgeven en de klant aangeven dat er bij de bovendeur van het appartement is gebeld.

**Aanwijzing:** De beltoon van de etagebeldrukker kan niet worden gewijzigd. Deze verschilt van een beltoon van de deurvideomodule, zodat duidelijk is waar de deuroproep werd gestart. De etagebeldrukker leidt niet tot enige interactie op de monitor. Er klinkt alleen een korte beltoon.

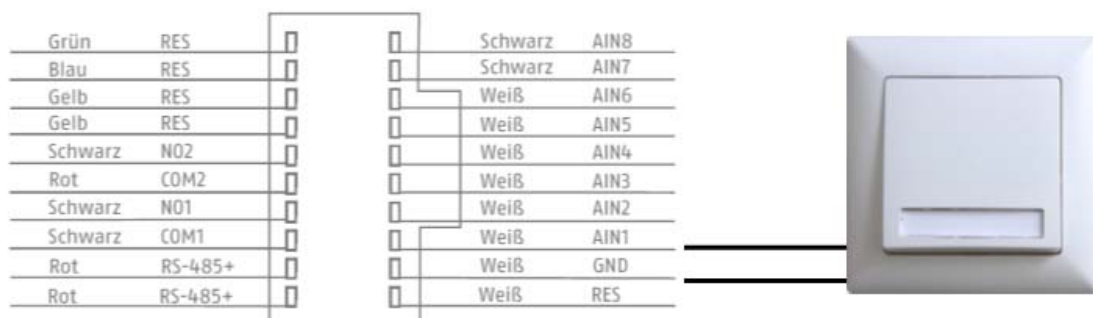
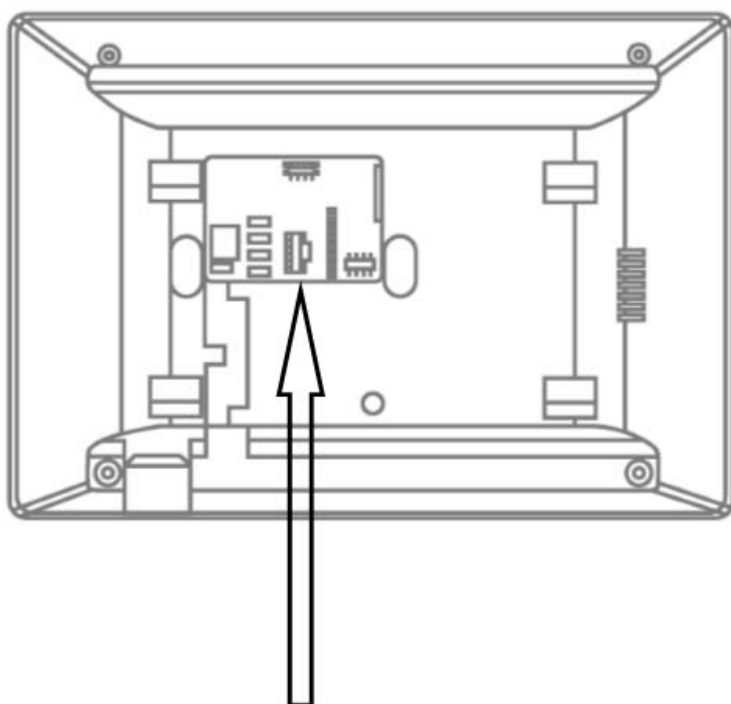

### 9.8 Elektrische deuropener op videomodule (incl. "tuindeur") aansluiten

2 onafhankelijke relais kunnen op de deurvideomodule worden geschakeld zodat bijvoorbeeld de deuren kunnen worden geopend. Om de relais te configureren, opent u de externe configuratie van de deurvideomodule in de ABUS CMS-software en schakelt u over naar het menu "Intercom" / "IO in out".

Onder "IO out" kunnen de respectievelijke relais voor DOOR 1 en DOOR 2 worden geconfigureerd, indien nodig ook gedeactiveerd. Als het relais is gedeactiveerd, verschijnt het "sleutel"-symbool voor het openen van de deur niet in de ABUS Link Station App of direct op de monitor.

Aanwijzing: Slechts één van de twee relais mag op "securityModule" (veiligheidsmodule TVHS10040) worden ingesteld.

Knop/weergave	Beschrijving
Disable	Het relais wordt niet gebruikt en is verborgen
electricLock	Het interne relais van de deurvideomodule wordt gebruikt
securityModule	De externe veiligheidsmodule TVHS10040 wordt gebruikt. (Zie menupunt "Veiligheidsmodule")

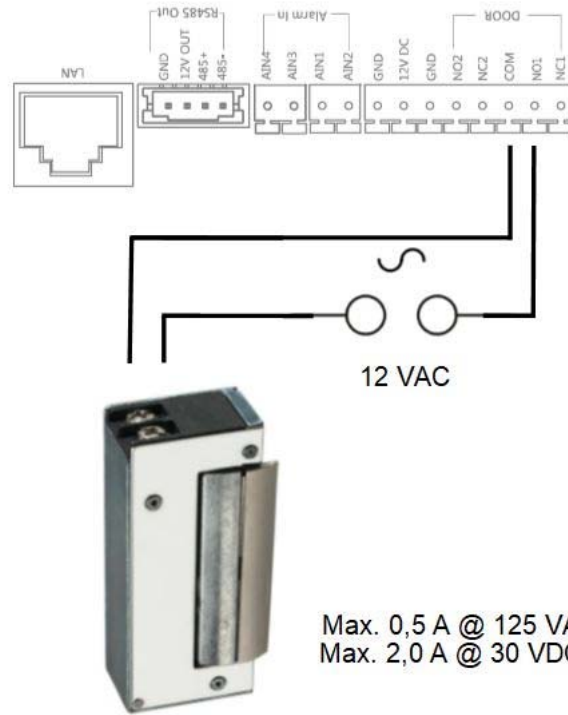
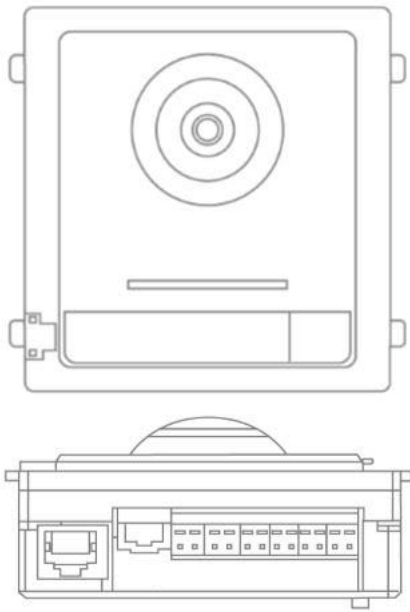

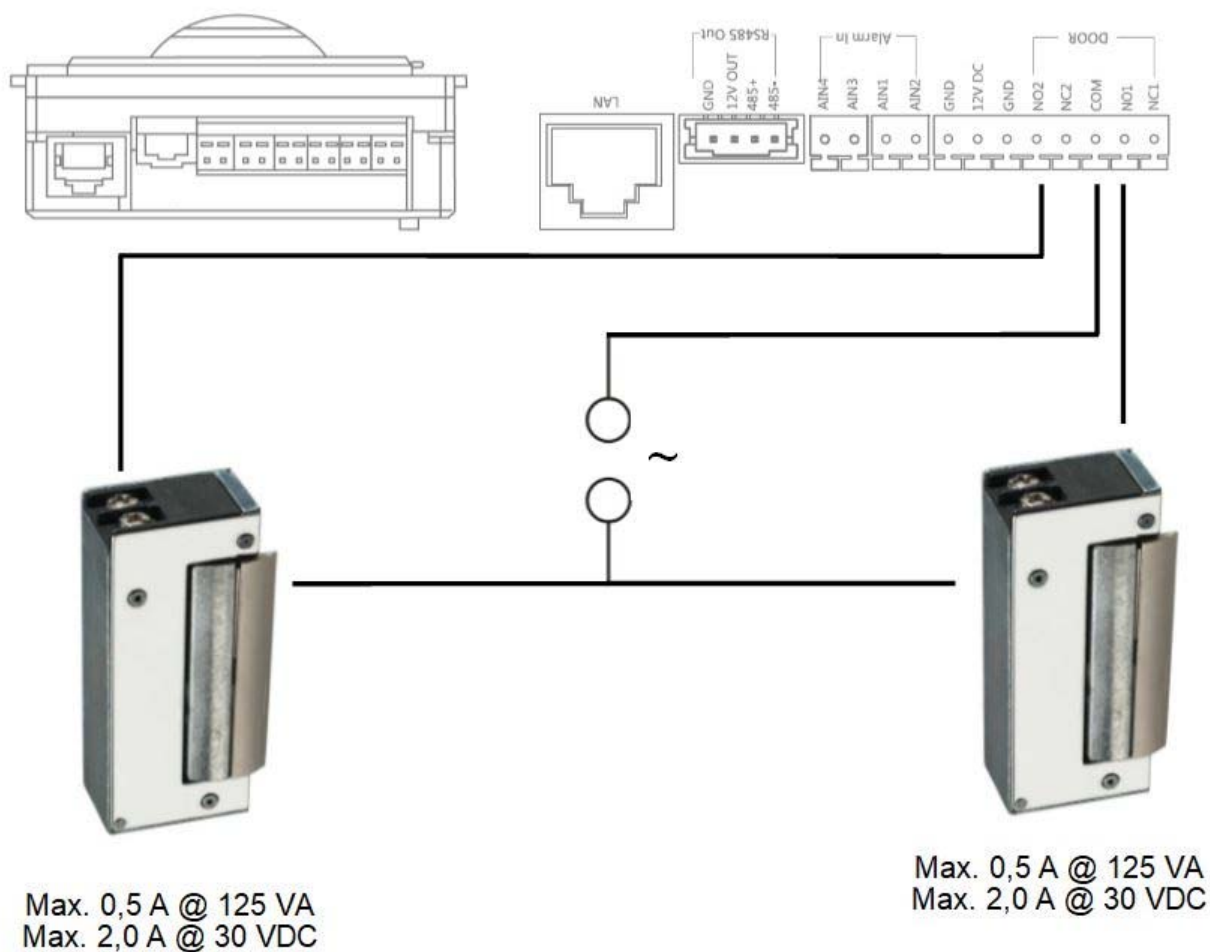

### 9.9 Eigen beltonen in de monitor van het deurstation laden

Via de ABUS CMS-software kunt u uw eigen beltonen in \*wav-formaat afspelen op uw monitor. Hiervoor opent u de remote-configuratie van de betreffende monitor en schakelt u over naar het menu "Ring import" onder "Intercom". Selecteer hier een vrij slot en upload het \*WAV-audiobestand. Na een succesvolle upload is het bestand direct beschikbaar op de monitor onder "Beltonen".

**Let op:** Een beltoon die in de monitor is geselecteerd, kan niet via ABUS CMS worden verwijderd. Selecteer eerst een andere beltoon op de monitor en probeer dan opnieuw de beltoon in het CMS te verwijderen.

Houd rekening met de volgende parameters van het WAV-bestand:

Formaat: wav;  
 Maximale grootte: ≥300Kb;  
 Bitrate: 8KHz;  
 Kanaal: Mono  
 Bitrate: 128Kbps

## Remote Configuration



- System
  - Device Information
  - General
  - Time
  - System Maintenance
  - User
  - RS485
- Intercom
  - ID Configuration
  - Time Parameters
  - Permission Password
  - Zone Alarm
  - IP Camera Information
  - Volume Input/Output
  - Ring Import
- Deploy Info
- Incoming Call Linkage
- Relay
- Network

### Ring Configuration

Index	Name	Size	Type	Add	Delete
1	Sprach...1_sd_2	185466	wav	+	×
2				+	×
3				+	×
4				+	×



## 9.10 ABUS CMS: firmware Moduvis-componenten update

**Let op:** Koppel nooit de stroomtoevoer of de netwerkkabel los tijdens een upgrade

**Let op:** Voer de update alleen uit in een stabiele netwerk omgeving (LAN).

Aanbevolen wordt om elk apparaat na een firmware-update op de fabrieksinstellingen te resetten.

Om een firmware-update te installeren op een monitor of de videodeurmodule is de ABUS CMS-software nodig. Verbind de apparaten met het netwerk en open de remote-configuratie van de betreffende apparaten.

Ga naar "Maintenance" / "System Maintenance" en selecteer het juiste bestand voor het apparaat.

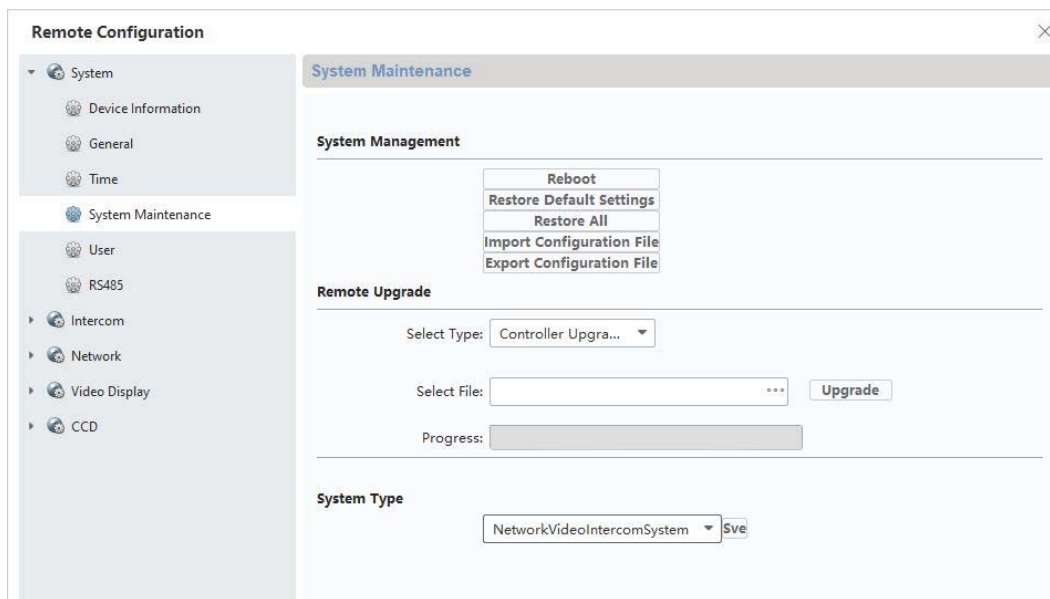

Bij het updaten van een deurvideomodule (TVHS20000, TVHS20010) moet "Controller-Upgrade" worden geselecteerd.

De actuele firmwareversie kan worden bepaald met behulp van ABUS IP Installer of in de CMS-software in de betreffende apparaatconfiguratie onder "Device Information".

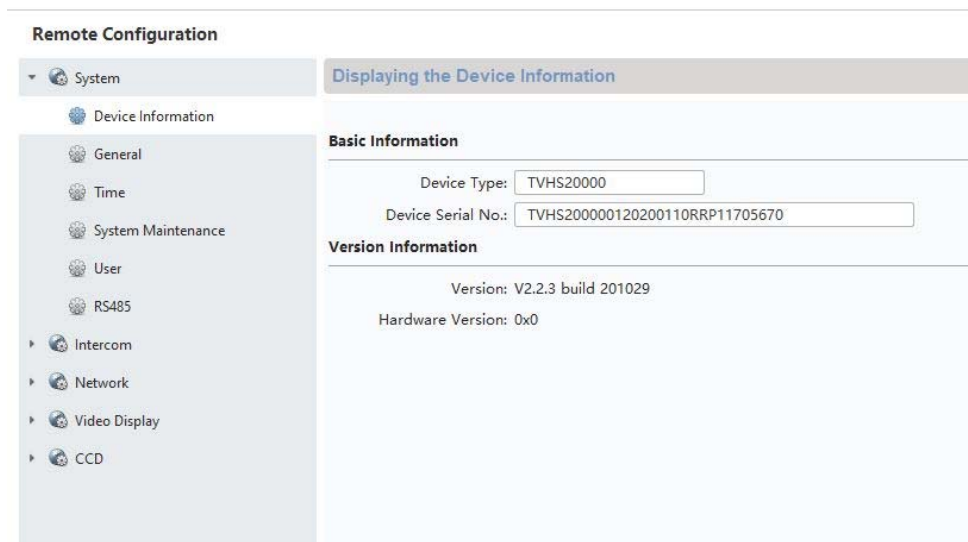

## 9.11 ABUS CMS: geavanceerde instelmogelijkheden

Hieronder volgt een kort overzicht van de instelmogelijkheden via de remote-configuratie met de ABUS CMS-software.

Elke monitor en deurvideomodule verschijnt als een onafhankelijk netwerkapparaat in het netwerk. Het maakt niet uit of het apparaat via 2-draads of PoE is aangesloten.

Remote-instellingen van **TVHS20000**, **TVHS20010**, videodeurmodule:

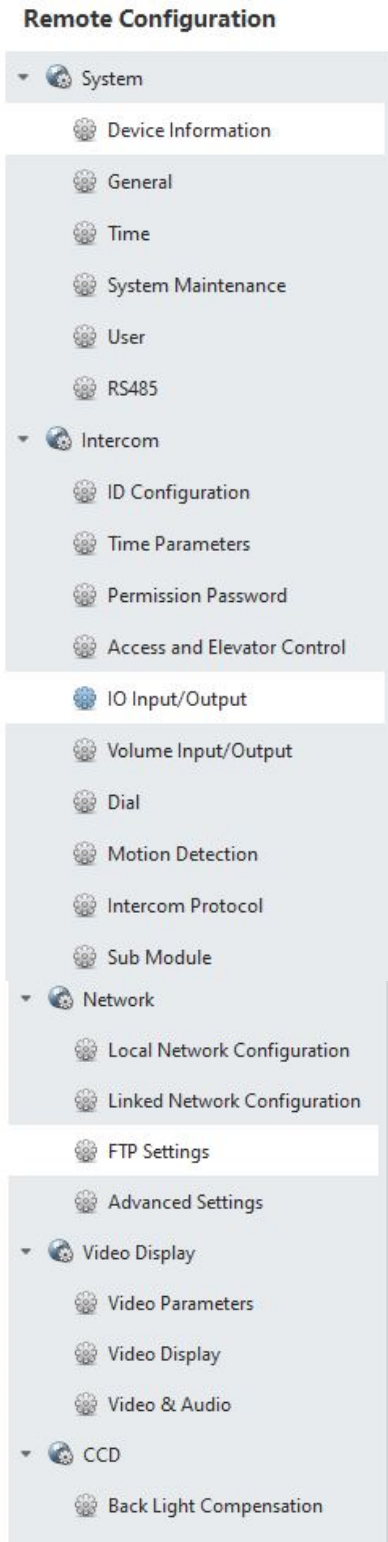

	Sectie "Systeem"
Device Information	Algemene informatie over firmware, serienummer
General	Apparaatnaam en apparaat-ID (niet relevant voor deurintercomsysteem)
Time	Instellingen voor datum/tijd, zomertijd en NTP-server
Maintenance	Onderhoudsmenu voor het updaten van de firmware, het instellen van de fabrieksinstellingen en het herstarten van het apparaat
User	Menu wordt niet gebruikt
	Sectie "Intercom"
ID Configuration	"Device-Typ" moet altijd op "Outdoor unit" staan. Verander a.u.b. geen numerieke waarden van de eenheden "Period, Building, Unit, Floor", omdat deze waarden hier niet nodig zijn. Onder "No.:" worden neveningangen ingesteld. 0 = hoofddeur, "1" - "9" = neveningangen. Zie het hoofdstuk "Neveningangen installeren". (Zie <u>Instructies voor installatie- en ingebruikname</u> )
Time Parameters	<b>Max talk time:</b> Maximale gespreksduur van een aangenomen oproep. (90-120s) <b>Max Msg time:</b> Opnameduur van antwoordapparaat (30-60s)
Permission password	Hier kunnen 3 extra pincodes (6 cijfers) worden ingesteld voor gebruik in combinatie met TVHS20030.
Access and elevator control	<b>Door. No.:</b> Keuze tussen relaisuitgang 1 of 2. <b>Open door time:</b> Bepaalt de tijd waarvoor het relais de deuropener moet bedienen. (1-255s)  <b>"Door name"</b> en <b>"Card encrypt"</b> worden niet gebruikt.
IO Input/ Output	Instellingen van de digitale ingangen (voor nooddeuropener) en de relais voor

	deuropener.
Volume Input Output	Instellingen van de audioparameters van de videodeurmodule. (Zie <u>Instructies voor installatie- en ingebruikname</u> )
Dial	Stelt de appartementstoewijzing voor de beldrucker op de deurvideomodule zelf in. De fabrieksinstelling voor "room No," is een "1". Zo wordt de monitor met het appartementnummer 1 opgeroepen.
Motion	Instelling van de bewegingsdetectie in verband met ABUS NVR. (De bewegingsdetectie wordt alleen via de ABUS NVR direct ingesteld en geconfigureerd)
Intercom Protocol	Wordt niet gebruikt
Sub Module	Overzicht van aangesloten uitbreidingsmodules zoals: TVHS20020, TVHS20030, TVHS20040
	Sectie "Network"
Local NetCfg	IP-adres van videodeurmodule. ( <b>IP-adres, subnetmasker, standaardgateway</b> )  <b>Poort: 8000</b> is nodig voor integratie in een ABUS NVR  <b>http Port</b> is niet nodig omdat er geen webinterface is
Linked network configuration	Menupunt wordt niet gebruikt met een hoofdvideodeurmodule.  <b>Main Outdoor IP Adress:</b> Wordt gebruikt bij het toewijzen van het hoofddeurstation aan een neveningang. (Zie <u>Instructies voor installatie- en ingebruikname</u> )
FTP Configuration	Wordt niet gebruikt
Advanced	Configuratie van het DNS-serveradres van de deurvideomodule
	Sectie "Display"
Video Parameters	Instellingen van de beeldparameters (helderheid, contrast, verzadiging)
Video Display	Instellingen OSS-weergave (cameranaam, datum, tijd, tekstpositie)
Video&Audio	Instelling van de streamparameters van de camera van de videodeurmodule. <b>Let op:</b> Het wordt niet aanbevolen om de instellingen te wijzigen.
Back Light compensation	Instelmogelijkheden van de BLC-functie ter compensatie van de achtergrondverlichting.

## Remote-configuratie "Monitor TVHS20200, TVHS20210":

System
Device Information
General
Time
System Maintenance
User
RS485
Intercom
ID Configuration
Time Parameters
Permission Password
Zone Alarm
IP Camera Information
Volume Input/Output
Ring Import
Deploy Info
Incoming Call Linkage
Relay
Network
Local Network Configuration
Linked Network Configuration
Advanced Settings
ABUS Link Station

Device Information	Informatie zoals "Firmware", "Serienummer" enz.
General	Apparaatnaam en apparaat-ID (niet relevant voor deurintercomsysteem)
Time	Instellingen voor datum/tijd, zomertijd en NTP-server
Maintenance	Onderhoudsmenu voor het updaten van de firmware, het instellen van de fabrieksinstellingen en het herstarten van het apparaat
User	Wordt niet gebruikt
RS485	Wordt niet gebruikt
	Sectie "Intercom"
ID Configuration	Selectie van het appartementnummer (woningnummer) in de bedrijfsmodus "Indoor Station" (hoofdmonitor) In de modus "Station Extension" (extra monitor) wordt het nummer van de extra monitor geconfigureerd.  Aanwijzing: De keuze van de bedrijfsmodus "hoofdmonitor" of "extra monitor" en de toewijzing van de nummers gebeurt meestal via het menu van de betreffende monitoren zelf. (bijvoorbeeld: tijdens het installatieproces via de installatiewizard)
Time Parameters	Instellingen van de oproepduur, duur van de weergave van het livebeeld, vertraging van de oproepdoorschakeling, duur van het belsegnaal. Aanwijzing: Deze instellingen kunnen ook direct in het menu van de monitor worden gewijzigd.
Permission Password	Wordt niet gebruikt in de remote-configuratie van de monitor.
Zone Alarm	Wordt niet gebruikt
IP camera information	Toevoegen van ABUS-netwerkcamera's. (Zie compatibiliteitslijst) Er kunnen maximaal 16 ABUS-netwerkcamera's worden toegevoegd en live worden bekeken. (Geen weergave of configuratie van de camera via het deurstation direct mogelijk)
Volume Input Output	(Zie <u>Instructies voor installatie- en gebruiknaam</u> )

Ring Import	Beheer eigen beltonen (zie <u>Instructies voor installatie- en ingebruikname</u> )
Deploy Info	Wordt niet gebruikt
Incoming Call Linkage	Wordt niet gebruikt
Trigger	Wordt niet gebruikt
	Sectie "Network"
Local NetCfg	IP-adres van de monitor. ( <b>IP-adres, subnetmasker, standaardgateway</b> )  <b>Poort: 8000</b> is hier niet nodig  <b>http Port</b> is niet nodig omdat er geen webinterface is
Linked network configuration	Toewijzing van de hoofdmonitor aan de hoofddeurvideomodule. In het geval van een hoofdmonitor wordt hier het IP-adres van de hoofddeurmodule ingevoerd. Het item "MainOutdoorUnit" mag niet worden gewijzigd. <b>Aanwijzing:</b> De toewijzing van de deurvideomodule aan de monitor gebeurt meestal tijdens de installatie ter plaatse op de monitor zelf.
Advanced	Configuratie van de DNS-server vanaf de monitor.
ABUS Link Station	Configuratie van de toegang via ABUS Link Station App. <b>Zie ABUS-instellingen Link Station-service.</b> De verbinding met de ABUS Link Station App kan eenvoudig worden gemaakt via de interface op de monitor zelf.

### 9.12 Functie-omvang MODUVIS en ABUS Link Station APP

De MODUVIS-deurintercom kan in de ABUS Link Station APP worden geïntegreerd. De volgende mogelijkheden zijn beschikbaar:

Verification Code wijzigen: De verificatiecode moet eerst worden gewijzigd in het menupunt "ABUS Link Station Service". Klik op de code die op dat moment wordt weergegeven.

Toevoegen: Scan de QR-code en voeg het apparaat toe aan de APP. Verder moet de verificatiecode worden ingevoerd

Apparaat delen:	Het deurintercomsysteem kan worden gedeeld met andere gebruikers. Op deze manier hebben meerdere personen of apps toegang tot het systeem.
Push-mogelijkheden:	Als de beltoon van de deurintercom klinkt, kan de ABUS Link Station App direct of met vertraging worden opgeroepen. De oproep kan via de app worden aangenomen en de intercom met de video van het deurstation kan worden gebruikt. Als de ontvangstkwaliteit of de mobiele bandbreedte beperkt is, kan de video worden gedeactiveerd en alleen het geluid worden weergegeven.
Deur open:	relais 1 of relais 2 kunnen via de app worden geschakeld. Hiermee kunnen bijvoorbeeld elektrische deuropeners worden bediend.
Gebeurtenissenlogboek:	De app heeft een berichtenpagina met de gegevens van de laatste belactiviteiten met een afbeelding van de gebeurtenis.

### 9.13 Compatibiliteit met ABUS-producten

Dit hoofdstuk behandelt een mogelijke interactie met andere ABUS-producten.

ABUS-product	Compatibiliteit
Secvest	Nee
WAppLoxx	Relaiscircuit
WAppLoxx Pro	Relaiscircuit
ABUS IP-camera's	Zie compatibiliteitslijst <a href="http://www.abus.com">www.abus.com</a> , <a href="http://www.abus-sc.de">www.abus-sc.de</a>
ABUS NVR	Integratie van de video van het deurstation, zie paragraaf 9.14
ABUS Link Station APP	Oproep van het livebeeld van het deurstation Pushbericht bij beltoon

### 9.14 Videodeurmodule in ABUS NVR integreren

Het videobeeld van de videodeurmodule kan ook in een ABUS NVR worden geïntegreerd. De video wordt afgetapt met behulp van het RTSP-protocol, dat alleen permanente weergave of permanente opname mogelijk maakt (geen bewegingsdetectie of andere soorten gebeurtenisopname).

	Let op de gegevensbeschermingsvoorschriften op de plaats van installatie!
---	---

Voor de integratie zijn de volgende stappen nodig:

1. Creëren van een door de gebruiker gedefinieerd protocol in het camerabeheer van de ABUS NVR.
2. De volgende streamdetails moeten worden gebruikt:  
Protocol: RTSP  
Overdrachtsprotocol: automatisch  
Poort: 554 (standaardpoort)  
Streampad: streaming / kanalen / 101 (hoofdstream)  
Streaming / kanalen / 102 (substream)

3. Bij het toevoegen van een nieuw kanaal aan de NVR, wordt dit aangepaste protocol geselecteerd voor de videodeurmodule.  
De gebruikersnaam ("admin") en het wachtwoord zijn meestal hetzelfde als de deurpostmonitor. Als het wachtwoord is gewijzigd via de CMS-software, moet dit gewijzigde wachtwoord worden gebruikt.

### 9.15 "Nooddeuropener" knop op de deurvideomodule

Via alar mingang 3 (AIN 3 = relais 1) en alar mingang 4 (AIN 4 = relais 2) kan een knop/schakelaar direct op de deurvideomodule worden aangesloten, die bij bediening het deurrelais schakelt.

Om de alar mingang 3 (AI3 en AI4) te activeren, opent u de remote-configuratie van de betreffende deurvideomodule met de ABUS CMS software en zet u AI3 op "openDoorBtn".

De AIN3 van de deurvideomodule opent nu de deur van het relais 1  
De AIN4 van de deurvideomodule opent nu de deur van het relais 2

Om veiligheidsredenen is deze functie bij levering gedeactiveerd.

The screenshot shows a configuration window titled "IO In Out". It is split into two main sections: "IO In" and "IO Out".

- IO In section:**
  - IO In No.: AI3
  - Use In: openDoorBtn
- IO Out section:**
  - IO Out No.: DOOR1
  - Use out: electricLock
  - Save button

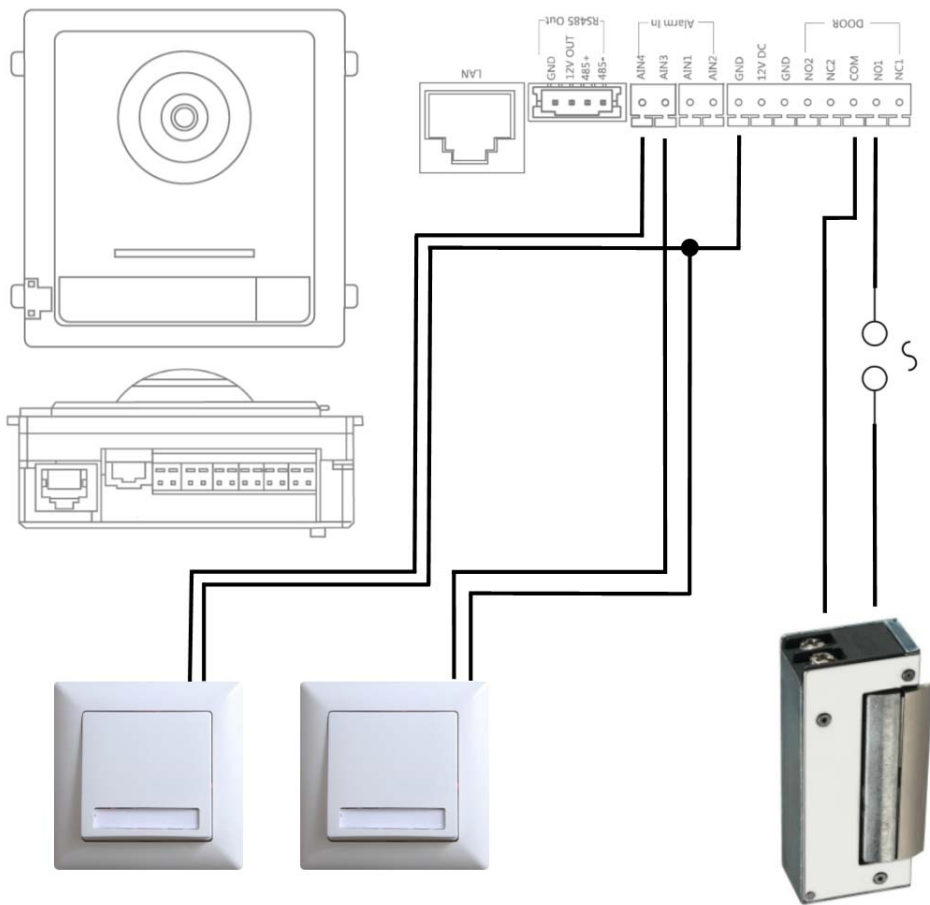

Max. 2A @ 30 VDC

Max. 0.5A @ 125 VAC



## 9.16 Relaiscircuit

De relais van de deurvideomodule (TVHS20xxx), de veiligheidsmodule TVHS10040 en de monitoren TVHS20xxx mogen met maximaal 2A 30VDC / 0,5A 125AC worden geladen. Een overbelasting zal resulteren in een defect van het apparaat.

Controleer stroomopname van uw bestaande deuropener/motorslot. Als de toegestane stroom wordt overschreden, raden wij aan een extern relais aan te sluiten.

De deurvideomodule heeft een aparte 12V DC-spanningsuitgang. Hierdoor kan een extern hulprelais direct worden aangesloten zonder verdere voedingspanning.

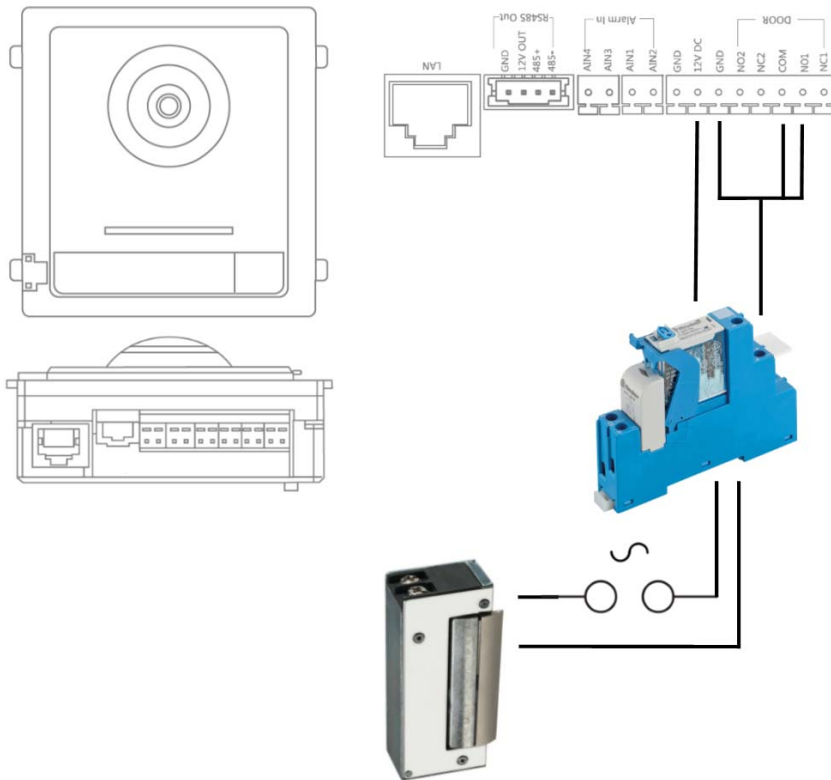

Relais voor DIN-rail:

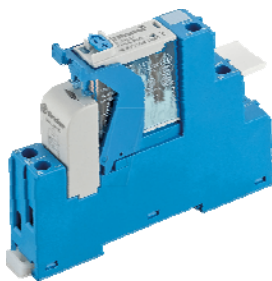

Voorbeeld: Kant-en-klaar gemonteerd 12V-relaisbord



### 9.17 Handleiding voor meten van bestaande deuropener

Als u een reeds bestaande deuropener wilt aansturen en u hebt hier geen informatie over de stroomopname, moet u bepalen of de maximale stroomopname het relais niet overbelast voordat u het op het relais van de deurvideomodule aansluit.

Meet hiervoor de stroomopname van de deuropener met een in serie geschakelde multimeter in het stroommeetbereik (A).

### 9.18 Toepassingsvoorbeeld "videomodule voor elke woningdeur"

Vaak is er de wens om ook een videomodule voor elke appartementsdeur in een appartementsgebouw te plaatsen om een 180 ° video te krijgen van het gebied voor de appartementsdeur (kijkgaten zijn meestal erg scherp in uw vakgebied). visie).

Met de functie "Zij-ingang" in de videomodule kan deze voor maximaal 16 woningdeuren worden geprogrammeerd.

#### LAN-variant

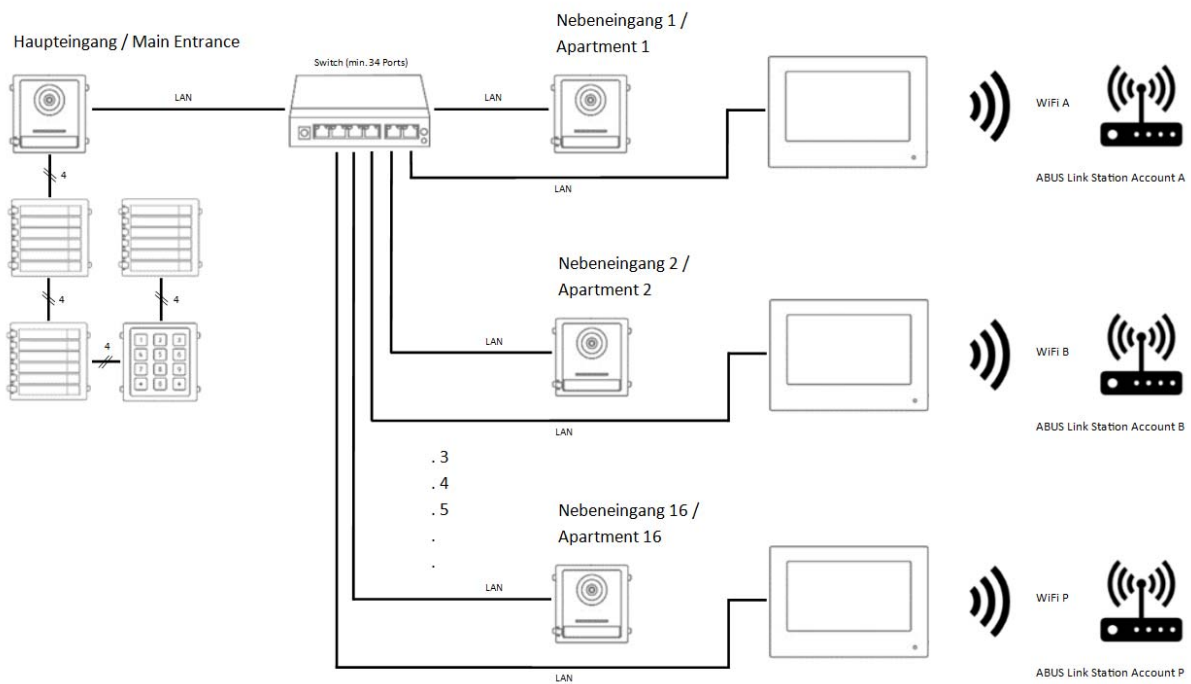

#### 2-draads variant

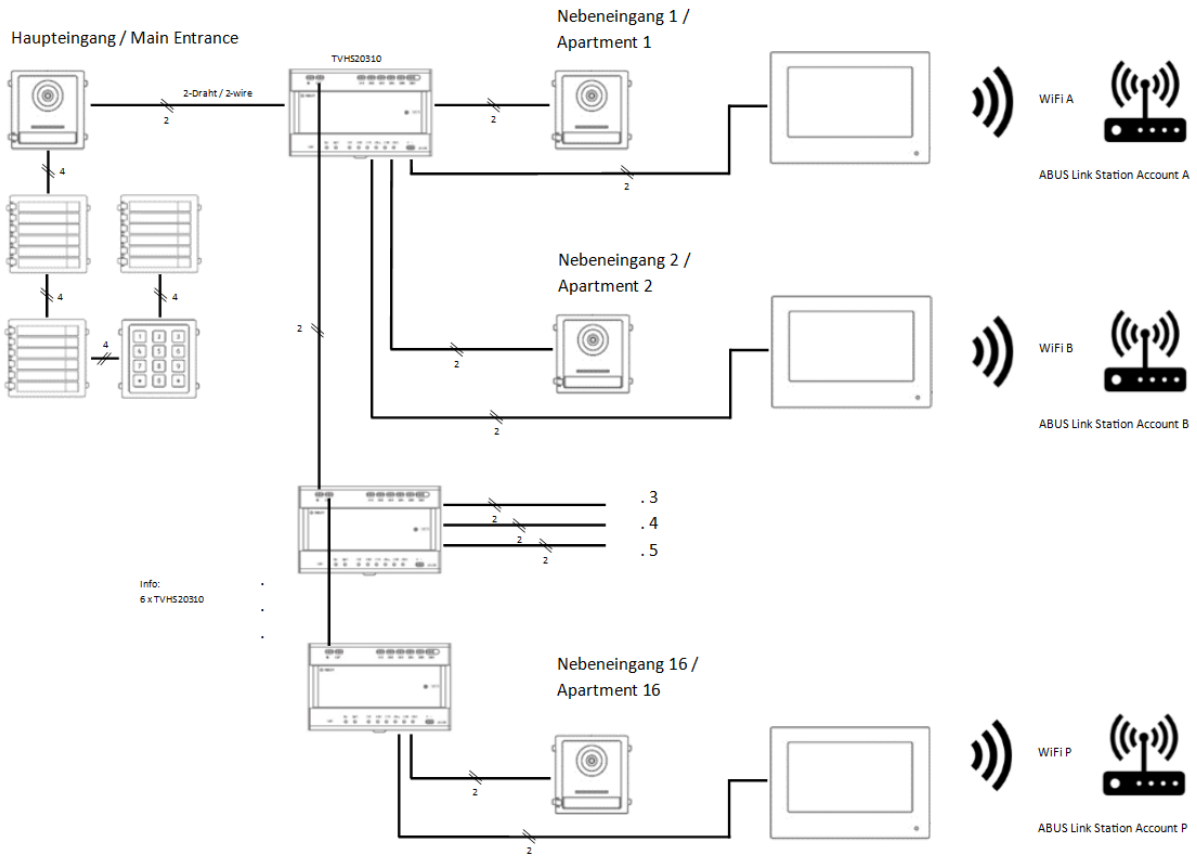

### Remote Configuration

- System
  - Device Information
  - General
  - Time
  - System Maintenance
  - User
  - RS485
- Intercom
  - ID Configuration
  - Time Parameters
  - Permission Password
  - Access and Elevator Control
  - IO Input/Output
  - Volume Input/Output
  - Dial
  - Motion Detection
  - Intercom Protocol
  - Sub Module
- Network
- Video Display
- CCD

#### Configuring the Room Numbers

**Device No. Configuration**

Device Type:

Project No.:

Community No.:

Building No.:

Floor No.:

No.:

**Reboot**

?

Master Outdoor Device to Slave Device will cause the device to reboot, Are you sure?

**Remote Configuration** ✕

- Time
- System Maintenance
- User
- RS485
- ▼ Intercom
  - ID Configuration
  - Time Parameters
  - Access and Elevator Control
  - IO Input/Output
  - Volume Input/Output

**Configuring the Network and Sip Parameters**

**Linked Network Configuration**

Device Type:

Master Station IP Address:

(Main) Door Station IP Address:

SIP Server IP Address:

Security Control Panel IP Address:

Security Control Panel Port No.:

**Remote Configuration** ✕

- ▼ System
  - Device Information
  - General
  - Time
  - System Maintenance
  - User
  - RS485
- ▼ Intercom
  - ID Configuration
  - Time Parameters
  - Permission Password
  - Access and Elevator Control
  - IO Input/Output
  - Volume Input/Output
- Dial
- Motion Detection
- Intercom Protocol
- Sub Module
- ▶ Network
- ▶ Video Display
- ▶ CCD

**Configuring the Key Call Room Parameters**

**Dial**

Number:

Room No.:

Quick Press for Calling Center





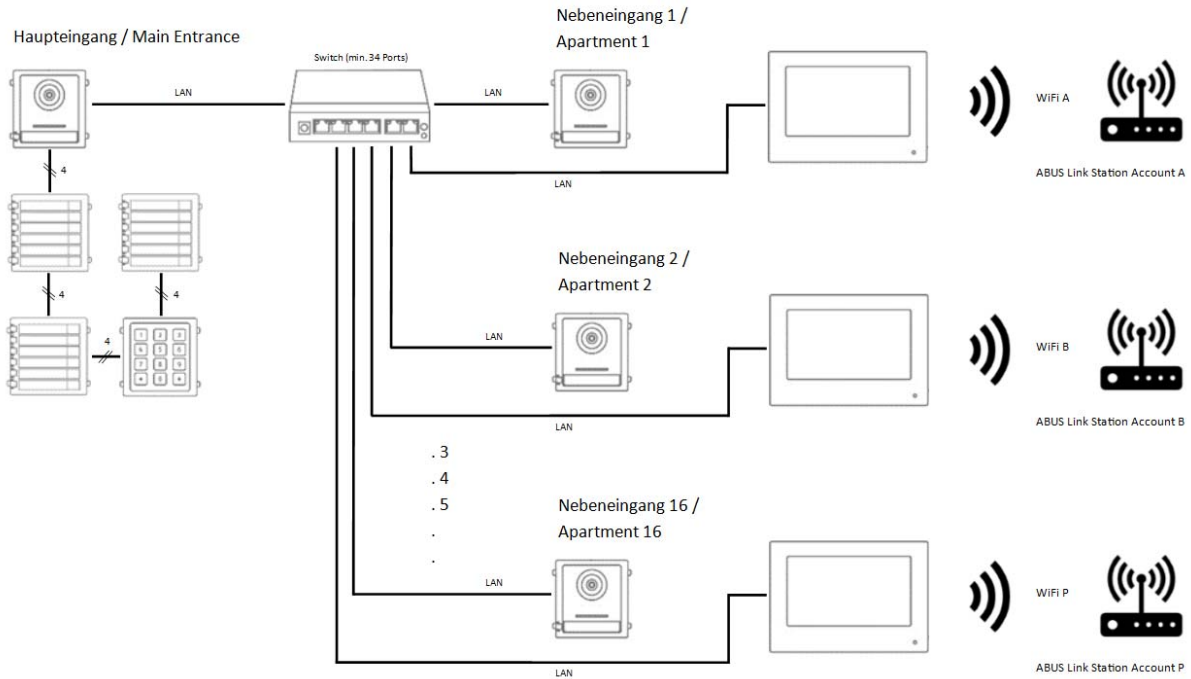

### 9.19 Toepassingsvoorbeeld "Individuele WiFi-toegang"

In een appartementengebouw is er vaak geen centrale internetverbinding voor alle wooneenheden. Elke wooneenheid kan een eigen internetverbinding hebben.

Via de wifi-functie van de hoofdmonitor kan een verbinding met de klantspecifieke internetverbinding tot stand worden gebracht.

Dit betekent dat er ook toegang is tot de ABUS Link Station-functie met push-notificatie wanneer er voor elke wooneenheid afzonderlijk wordt gebeld.



Wlan-Einstellungen		
	<input type="checkbox"/>	
MAX_MUSTERWLAN		
		

## 10. Bedradingsgeleider (2-draads)

Een document met meer informatie over de bedrading van de 2-draads deurintercom is te vinden op [www.abus.com](http://www.abus.com), bijvoorbeeld op het product TVHS20010:

[https://www.abus.com/var/ImagesPIM/d110001/medias/docus/25/Moduvis\\_Verkabelung\\_Wiring\\_2wire\\_V1.1.pdf](https://www.abus.com/var/ImagesPIM/d110001/medias/docus/25/Moduvis_Verkabelung_Wiring_2wire_V1.1.pdf)

## MODUVIS Dørsamtaleanlæg TVHS20XXX(S)

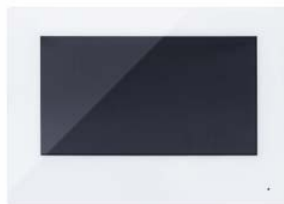

## Betjeningsvejledning

Version 06/2021 (V1.2)



*Dansk oversættelse af den originale tyske betjeningsvejledning. Opbevares til fremtidig anvendelse!*

## **DK Indledning**

Kære kunde

Tak, fordi du har valgt at købe dette produkt.

### TVHS20000 / TVHS20000S

Udstyret opfylder kravene i følgende EU-direktiver: EMC-direktiv 2014/30/EU samt RoHS-direktiv 2011/65/EU.

### TVHS20010 / TVHS20010S

Udstyret opfylder kravene i følgende EU-direktiver: EMC-direktiv 2014/30/EU samt RoHS-direktiv 2011/65/EU.

### TVHS20020 / TVHS20020S

Udstyret opfylder kravene i følgende EU-direktiver: EMC-direktiv 2014/30/EU samt RoHS-direktiv 2011/65/EU.

### TVHS20030 / TVHS20030S

Udstyret opfylder kravene i følgende EU-direktiver: EMC-direktiv 2014/30/EU samt RoHS-direktiv 2011/65/EU.

### TVHS20040

Udstyret opfylder kravene i følgende EU-direktiver: EMC-direktiv 2014/30/EU samt RoHS-direktiv 2011/65/EU.

### TVHS20200

Hermed erklærer ABUS Security-Center, at udstyret er i overensstemmelse med RED-direktivet 2014/53/EU. Udstyret opfylder desuden kravene i følgende EU-direktiver: EMC-direktiv 2014/30/EU samt RoHS-direktiv 2011/65/EU. EU-overensstemmelseserklæringens fulde tekst kan findes på følgende internetadresse: [www.abus.com/product/TVHS20200](http://www.abus.com/product/TVHS20200)

### TVHS20210

Hermed erklærer ABUS Security-Center, at udstyret er i overensstemmelse med RED-direktivet 2014/53/EU. Udstyret opfylder desuden kravene i følgende EU-direktiver: EMC-direktiv 2014/30/EU samt RoHS-direktiv 2011/65/EU. EU-overensstemmelseserklæringens fulde tekst kan findes på følgende internetadresse: [www.abus.com/product/TVHS20210](http://www.abus.com/product/TVHS20210)

### TVHS20220

Hermed erklærer ABUS Security-Center, at udstyret er i overensstemmelse med RED-direktivet 2014/53/EU. Udstyret opfylder desuden kravene i følgende EU-direktiver: EMC-direktiv 2014/30/EU samt RoHS-direktiv 2011/65/EU. EU-overensstemmelseserklæringens fulde tekst kan findes på følgende internetadresse: [www.abus.com/product/TVHS20220](http://www.abus.com/product/TVHS20220)

### TVHS10040 / TVHS20340

Udstyret opfylder kravene i følgende EU-direktiver: EMC-direktiv 2014/30/EU samt RoHS-direktiv 2011/65/EU.



For at kunne bibeholde denne tilstand og sikre en ufarlig drift skal du som bruger følge denne betjeningsvejledning!

Læs hele betjeningsvejledningen igennem før idriftsættelsen af produktet, og overhold alle betjenings- og sikkerhedshenvisninger!

**Alle indeholdte firmanavne og produktbetegnelser er varemærker, der tilhører den pågældende ejer. Alle rettigheder forbeholdes.**

**I tilfælde af spørgsmål bedes du henvende dig til din installatør eller forhandler!**



#### **Ansvarsfritagelse**

Denne betjeningsvejledning er udarbejdet meget omhyggeligt. Hvis du alligevel finder mangler eller unøjagtigheder, bedes du meddele os dette.

ABUS Security-Center GmbH & Co. KG påtager sig intet ansvar for tekniske og typografiske fejl og forbeholder sig retten til på ethvert tidspunkt uden forudgående varsel at ændre produktet og betjeningsvejledningerne.

ABUS Security-Center er ikke ansvarlig for direkte og indirekte følgeskade, der opstår i forbindelse med dette produkts udstyr, funktion og anvendelse. Der gælder ingen garanti for indholdet i dette dokument.

## Vigtige sikkerhedshenvisninger



Ved skader, der skyldes manglende overholdelse af denne betjeningsvejledning, bortfalder garantien. Vi påtager os intet ansvar for følgeskader!



Vi påtager os intet ansvar i forbindelse med materielle skader og/eller personskader, der skyldes ukorrekt håndtering eller manglende overholdelse af sikkerhedshenvisningerne. I sådanne tilfælde bortfalder enhver form for garanti!

### Kære kunde

Følgende sikkerheds- og farehenvisninger anvendes ikke kun til at beskytte dig, men også til at beskytte udstyret. Læs følgende punkter grundigt igennem:

- Der er ingen dele inde i produktet, som du skal vedligeholde. Derudover bortfalder godkendelsen (CE) og garantien/garantiydelsen, hvis produktet åbnes/skilles ad.
- Produktet kan blive beskadiget, hvis det falder ned fra selv en lav højde.

Undgå følgende ugunstige omgivelsesbetingelser ved drift:

- Væde eller for høj luftfugtighed
- Ekstrem kulde eller varme
- Direkte sollys
- Støv eller brændbare gasser, dampe eller opløsningsmidler
- Kraftige vibrationer
- Kraftige magnetfelter f.eks. i nærheden af maskiner eller højttalere
- Kameraet må ikke installeres på ustabile flader.

Generelle sikkerhedshenvisninger:

- Lad ikke emballage ligge og flyde! Plastikfolier/-poser, styropordele osv. kan være farligt legetøj for børn.
- Videoovervågningskameraet må af sikkerhedsmæssige årsager ikke komme i hænderne på små børn på grund af smådele, der kan sluges.
- Før ikke genstande gennem åbningerne ind i udstyrets indre
- Anvend kun det ekstraudstyr/de tilbehørsdele, der er anført af producenten. Tilslut ikke produkter, der ikke er kompatible.
- Overhold sikkerhedshenvisninger og betjeningsvejledninger for andet tilsluttet udstyr.
- Kontrollér udstyret for skader før idriftsættelsen. Tag ikke udstyret i drift, hvis det er beskadiget!
- Overhold grænserne for driftsspændingen, der er anført i de tekniske data. Højere spændinger kan ødelægge udstyret og bringe din sikkerhed i fare (elektrisk stød).



Sørg ved installation i et eksisterende videoovervågningsanlæg for, at alt udstyr er koblet fra net- og lavspændingsstrømkredsen.



Foretag ikke selv montering, installation og kabelføring, hvis du er i tvivl, men overlad det til en fagmand. Ukorrekt og uprofessionelt arbejde på strømnettet eller på husets installationer er ikke kun en fare for dig selv, men også for andre personer.

Træk installationernes kabler, så net- og lavspændingskredse altid forløber adskilt og ikke er forbundet med hinanden på noget sted eller kan forbindes på grund af en defekt

## Indholdsfortegnelse

<b>1.</b>	<b>KORREKT ANVENDELSE</b> .....	<b>301</b>
<b>2.</b>	<b>SYMBOLFORKLARING</b> .....	<b>301</b>
<b>3.</b>	<b>SYSTEMOVERSIGT</b> .....	<b>302</b>
3.1	2-TRÅDET VARIANT.....	304
3.1.1	KOMPONENTER.....	304
3.1.2	ANBEFALEDE KABELTYPER.....	305
3.2	IP-NETVÆRKS VARIANT.....	305
3.2.1	KOMPONENTER.....	305
3.3	INSTALLATIONSKOMPONENTER.....	306
3.4	SYSTEMVARIANTER.....	307
<b>4.</b>	<b>IDRIFTSÆTTELSE</b> .....	<b>312</b>
4.1	KABELFØRING.....	312
4.1.1	INSTALLATIONSHØJDE.....	312
4.2	AKTIVERINGSMULIGHEDER / FØRSTE TILDELING AF KODEORD.....	313
4.2.1	AKTIVERING VIA DØRSTATIONS MONITOR.....	313
4.2.2	AKTIVERING VIA IP-NETVÆRK.....	316
4.2.3	NULSTILLING AF KODEORD MONITOR/VIDEO-DØRMODUL.....	316
<b>5.</b>	<b>BETJENING AF MONITOREN (2-TRÅDET OG IP)</b> .....	<b>317</b>
5.1	LIVEBILLEDE.....	317
5.2	HOVEDSIDE OVERSIGT.....	318
5.2.1	MENUPUNKT: OPKALDSINDSTILLINGER.....	323
5.2.2	WLAN-INDSTILLINGER.....	325
5.2.3	ETAGETASTER.....	326
5.2.4	ØVRIGE INDSTILLINGER.....	327
5.2.4.1	KONFIGURATION – LOKALE INFORMATIONER.....	327
5.2.4.2	KONFIGURATION – NETVÆRKSINDSTILLINGER.....	331
5.2.4.3	KONFIGURATION – ADMINISTRATION AF Udstyret.....	332
5.2.4.4	KONFIGURATION – STANDARDINDSTILLINGER.....	334
5.2.4	RELÆKONFIGURATION.....	334
5.2.5	MICROSD-KORT.....	335
5.2.6	SPÆRRING AF SKÆRM.....	335
5.2.7	INFORMATIONER OM Udstyret.....	335
5.2.8	TIDSINDSTILLING.....	335
5.2.9	GENSTART Udstyr.....	335
5.2.10	KODEORDSINDSTILLINGER (PIN-KODE).....	336
5.2.11	SYSTEMSPROG.....	337
5.2.12	INDSTILLING AF LYSSTYRKE.....	337
5.2.13	ETAGETASTER.....	337
5.2.14	OPEN SOURCE LICENSINFORMATIONER.....	337
<b>6.</b>	<b>VEDLIGEHODELSE OG RENGØRING</b> .....	<b>338</b>
6.1	FUNKTIONSTEST.....	338
6.2	RENGØRING.....	338
<b>7.</b>	<b>BORTSKAFFELSE</b> .....	<b>338</b>

<b>8.</b>	<b>OPEN SOURCE LICENSHENVISNINGER</b> .....	<b>338</b>
<b>9.</b>	<b>INSTRUKSER TIL INSTALLATION OG IBRUGTAGNING</b> .....	<b>339</b>
9.1	BRUG SIKKERHEDSMODUL (TVHS10040/TVHS20340) .....	339
9.2	OPSÆTNING SIDEINDGANGE .....	341
9.3	OPSÆTNING AF UDVIDEDE RINGEKLOKKER (TVHS20020) TIL FLERFAMILIESHUS .....	343
9.4	INDSTILLING AF LYDSTYRKE PÅ DØR-VIDEOMODULET (TVHS20000, TVHS20010).....	346
9.5	TILSLUTNING AF EN EKSISTERENDE DØRKLOCKE .....	347
9.6	TILSLUTNING AF EKSISTERENDE DØRÅBNER PÅ DØRSTATIONENS MONITOR .....	348
9.7	TILSLUTNING AF ETAGERINGEKLOKKER TIL HOVEDMONITOREN.....	349
9.8	TILSLUTNING AF ELEKTRISK DØRÅBNER TIL VIDEOMODULET (INKL. "HAVELÅGE") .....	350
9.9	TILPASNING AF EGNE RINGETONER PÅ DØRSTATIONENS MONITOR.....	352
9.10	ABUS CMS: UDFØR FIRMWAREOPDATERING AF MODUVIS-KOMPONENTERNE.....	353
9.11	ABUS CMS: UDVIDEDE INDSTILLINGSMULIGHEDER.....	355
9.12	FUNKTIONER MODUVIS OG ABUS LINK STATION APPEN.....	359
9.13	KOMPATIBILITET MED ABUS PRODUKTER .....	359
9.14	INTEGRERING AF VIDEO-DØRMODULET I ABUS NVR .....	359
9.15	"NØD-DØRÅBNER"-TAST PÅ DØR-VIDEOMODULET .....	360
9.16	RELÆTILSLUTNING .....	362
9.17	VEJLEDNING TIL MÅLING AF DEN EKSISTERENDE DØRÅBNER .....	363
9.18	ANVENDELSESEKSEMPEL "VIDEOMODUL FORAN HVER LEJLIGHEDSDØR".....	363
9.19	APPLIKATIONSEKSEMPEL "INDIVIDUEL WIFI-ADGANG".....	366
<b>10.</b>	<b>LEDNINGSFØRING (2-LEDER)</b> .....	<b>367</b>

## 1. Korrekt anvendelse

Dette MODUVIS dørsamtaleanlæg er et samtaleanlæg med videovisning af området ved døren. Anlægget kan bruges til en- og flerfamiliehuse. Takket være udvidelsesmonitorer i en boligenhed kan anlægget ligeledes bruges som samtaleanlæg (uden video) inden for boligenheden.

MODUVIS dørsamtaleanlægget er ikke et videoovervågningsanlæg og må ikke bruges som et sådant anlæg.



En anden anvendelse end beskrevet ovenfor kan medføre beskadigelse af produktet. Der er desuden andre farer. Enhver anden anvendelse er ikke korrekt og medfører tab af garantien eller garantiydelsen. Ethvert ansvar udelukkes. Dette gælder også, hvis der er foretaget ombygninger og/eller ændringer på produktet. Læs betjeningsvejledningen fuldstændigt og omhyggeligt igennem, før produktet tages i brug. Betjeningsvejledningen indeholder vigtige informationer om montering og betjening.

## 2. Symbolforklaring



Symbolet med lynet i trekanten anvendes, når der er helbredsfare, f.eks. på grund af elektrisk stød.



Et udråbstegn, der befinder sig i trekanten, gør opmærksom på vigtige anvisninger i betjeningsvejledningen, som ubetinget skal overholdes.



Dette symbol vises, når du skal have særlige tips og henvisninger vedr. betjeningen.

### 3. Systemoversigt

Dette dørsamtaleanlæg fås med to forskellige kabelføringsteknologier:

**2-trådet variant:** Kommunikation og spændingsforsyning sker via 2 tråde (1 par). Kabelføringen foretages stjerneformet, det centrale punkt er en 2-trådet fordeler. Et basissystem består af 2-trådet fordeler, 2-trådet monitor og 2-trådet videomodul.

**IP-variant:** Kommunikation og spændingsforsyning sker via Ethernet-(netværks)-kabel. Komponenterne understøtter Power-over-Ethernet (PoE) (efter ønske 12 VDC) Kabelføringen foretages stjerneformet, det centrale punkt er (PoE)-switchen. Et basissystem består af IP-monitor og IP-videomodul.

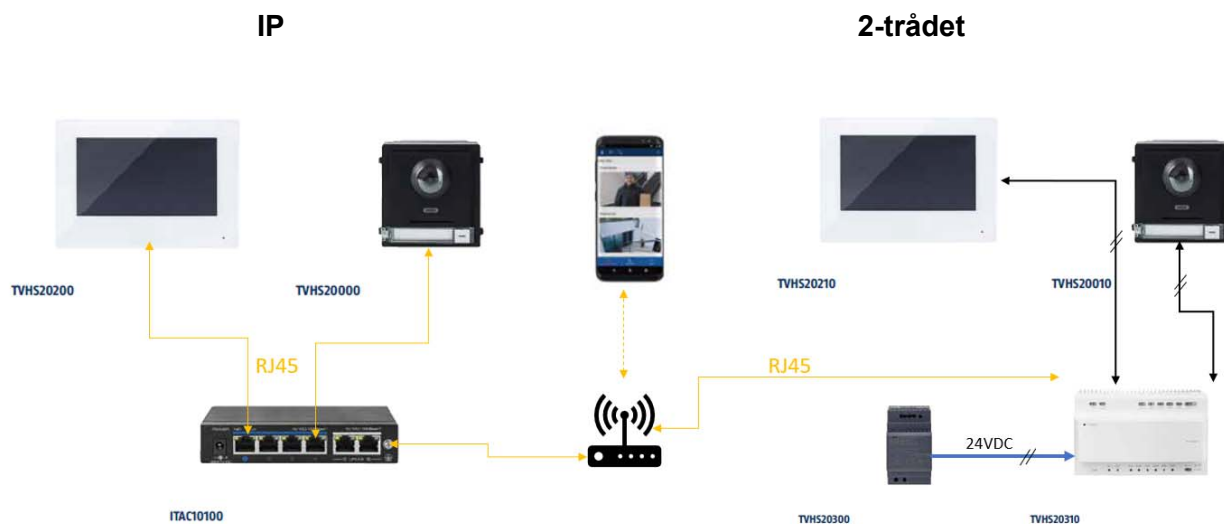

**Begge systemvarianter kan bruges i blandet drift. Dette giver mulighed for en optimal tilpasning til forholdene på stedet.**

### Eksempler på kombinerede systemer:

Dette eksempel viser den blandede betjening af en hovedmonitor via 2-leder og en udvidelsesmonitor via WiFi.

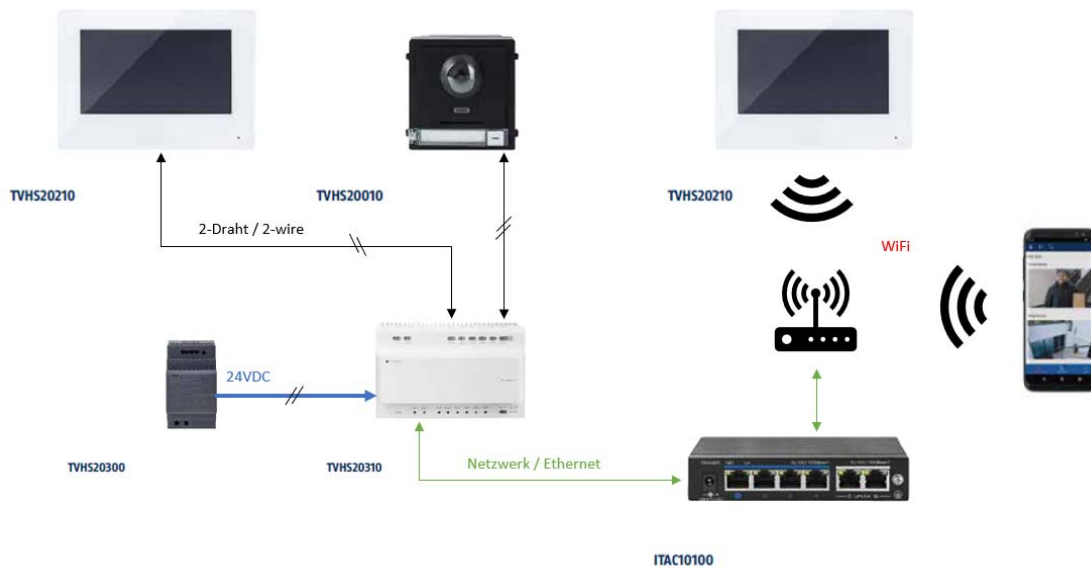



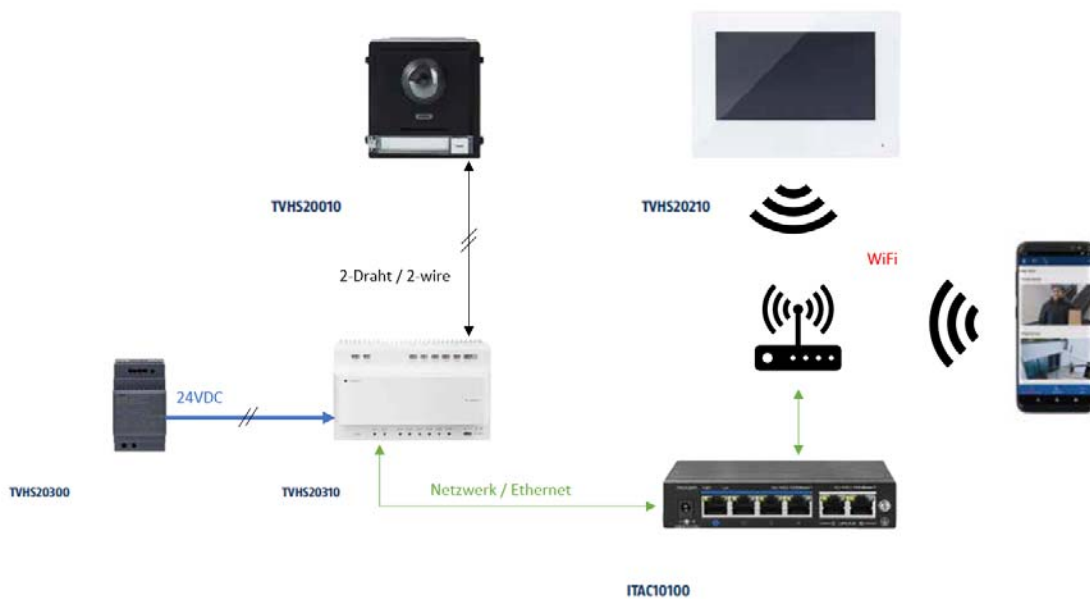





Dette eksempel viser den blandede betjening af et videodørmodul via 2-leder med en hovedmonitor via WiFi.

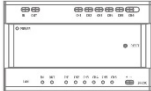

### 3.1 2-trådet variant

#### 3.1.1 Komponenter

<p>TVHS20210</p>  <p>2-trådet monitor</p>	<p>TVHS20010 / TVHS20010S</p>  <p>2-trådet videomodul</p>	<p>TVHS20310</p>  <p>2-trådet fordeler</p>
<p>TVHS20020 / TVHS20020S</p>  <p>Ringeklokke-modul (6-taster)</p>	<p>TVHS20030 / TVHS20030S</p>  <p>Nummertastatur</p>	<p>TVHS20040</p>  <p>Infomodul</p>
<p>TVHS20300</p>  <p>24 VDC strømforsyning til topskinne</p>	<p>TVHS10040 / TVHS20340</p>  <p>Sikkerhedsmodul</p>	



### 3.1.2 Anbefalede kabeltyper

Vælg den kabeltype, der passer til afstanden mellem videomodul, fordeler og monitor.

2-trådet videomodul (TVHS20010 / TVHS20010S)





2-trådet monitor (TVHS20210)

2-trådet fordeler (TVHS20310)

Kabeltype	24AWG (10 Ω pr. 100 m)	20AWG (7 Ω pr. 100 m)	18AWG (4 Ω pr. 100 m)
<b>Kabelføring</b>			
TVHS20310 / TVHS20310	Maks. 60 m	Maks. 60 m	Maks. 60 m
TVHS20010(S) / TVHS20310	Maks. 35 m	Maks. 60 m	Maks. 60 m
TVHS20210 / TVHS20310	Maks. 35 m	Maks. 60 m	Maks. 60 m









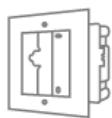
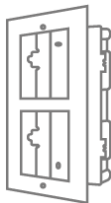

### 3.2 IP-netværksvariant

#### 3.2.1 Komponenter

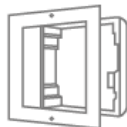
TVHS20200 / TVHS20220 " data-bbox="185 561 291 614"/> IP 7"/10" PoE monitor	TVHS20000 / TVHS20000S  IP videomodul	TVHS20020 / TVHS20020S  Ringeklokke-modul (6-taster)
TVHS20030 / TVHS20030S  Nummertastatur	TVHS20040  Infomodul	TVHS10040 / TVHS20340  Sikkerhedsmodul

### 3.3 Installationskomponenter

Disse tilgængelige installationskomponenter kan bruges til både den 2-trådede samt IP-varianten af Moduvis video-dørsamtaleanlægget

<p>TVHS20050</p>  <p>Tomt modul afdækning</p>	<p>TVHS20060</p>  <p>Afdækning til ubrugt ringeklokke</p>	<p>TVHS20100(S)</p>  <p>Ramme til 1 modul skjult montering</p>
<p>TVHS20110(S)</p>  <p>Ramme til 2 moduler skjult montering</p>	<p>TVHS20120(S)</p>  <p>Ramme til 3 moduler skjult montering</p>	<p>TVHS10130(S)</p>  <p>Ramme til 1 modul synlig montering</p>
<p>TVHS10140(S)</p>  <p>Ramme til 2 moduler synlig montering</p>	<p>TVHS10150(S)</p>  <p>Ramme til 3 moduler synlig montering</p>	<p>TVHS20160</p>  <p>Udendørshus til ramme synlig montering (1 modul)</p>
<p>TVHS20170</p>  <p>Udendørshus til ramme synlig montering (2 moduler)</p>	<p>TVHS20180</p>  <p>Udendørshus til ramme synlig montering (3 moduler)</p>	

### 3.4 Systemvarianter

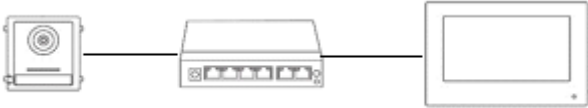
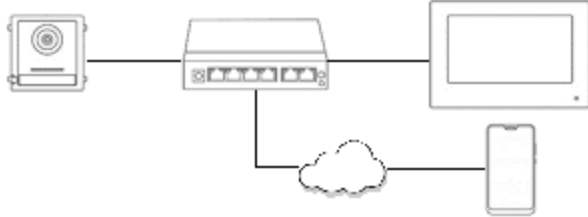
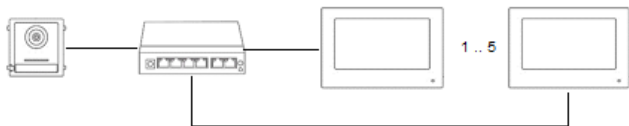
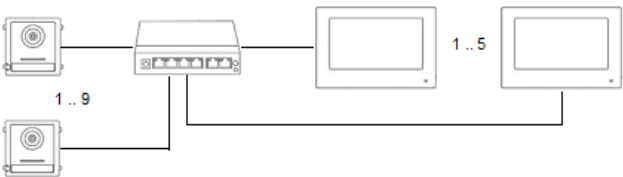
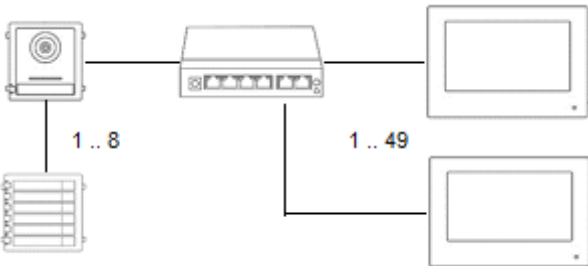
#	Teknologi / kabelføring	Systemopbygning	Eksempel på anvendelse
1	IP		Enfamiliehuse
2	IP		Enfamilieshus med app-adgang
3	IP		Enfamilieshus med indendørsudvidelsesmonitører
4	IP		Enfamilieshus med indendørsudvidelsesmonitører og sideindgange
5	IP		Flerfamiliehuse

6	IP		Flerfamilieshus med indendørsudvidelsesmonitorer
7	IP		Flerfamilieshus med indendørsudvidelsesmonitorer og nummertastaturmodul
8	IP		Flerfamilieshus med indendørsudvidelsesmonitorer, nummertastaturmodul og belyst info-modul
9	2-trådet		Enfamiliehuse
10	2-trådet		
11	2-trådet		Enfamilieshus med app-adgang

12	2-trådet		Enfamilieshus med indendørsudvidelsesmonitører
13	2-trådet		Enfamilieshus med indendørsudvidelsesmonitører og sideindgange
14	2-trådet		Flerfamiliehuse

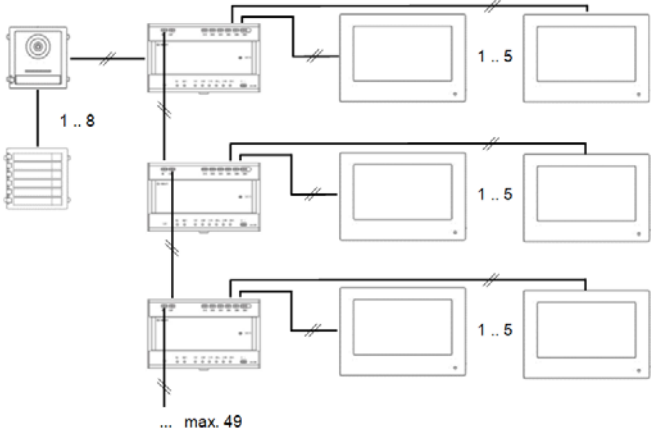
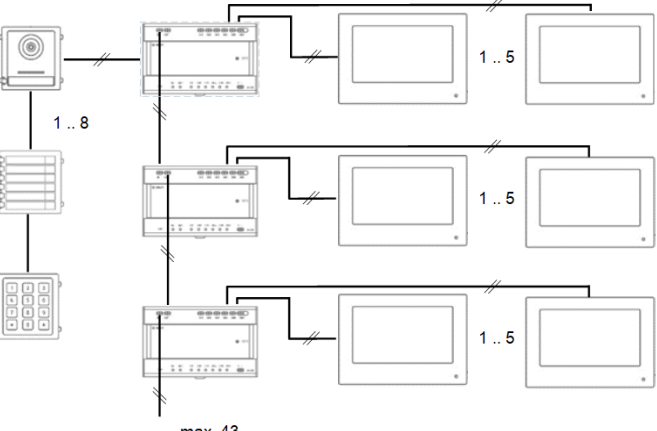
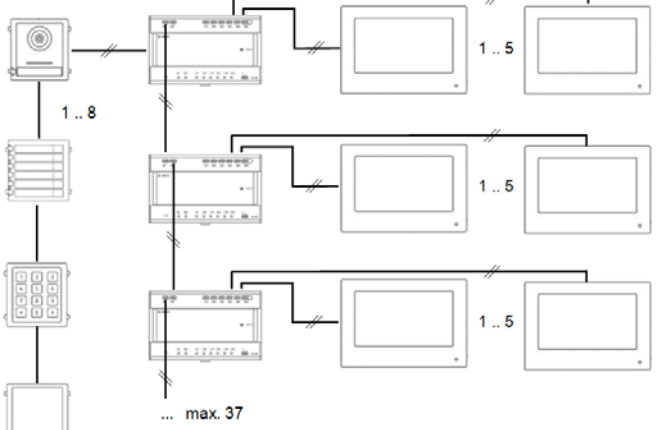
15	2-trådet	 <p>1..8</p> <p>1..5</p> <p>1..5</p> <p>1..5</p> <p>... max. 49</p>	Flerfamilieshus med indendørsudvidelsesmonitører
16	2-trådet	 <p>1..8</p> <p>1..5</p> <p>1..5</p> <p>1..5</p> <p>... max. 43</p>	Flerfamilieshus med indendørsudvidelsesmonitører og nummertastaturmodul
17	2-trådet	 <p>1..8</p> <p>1..5</p> <p>1..5</p> <p>1..5</p> <p>... max. 37</p>	Flerfamilieshus med indendørsudvidelsesmonitører, nummertastaturmodul og belyst info-modul

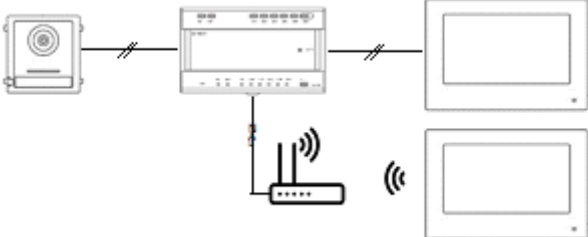
18	2-trådet / IP		<p><b>Kombination af 2-trådet og IP-teknologi:</b></p> <p><b>Indendørsudvidelsesmonitor via WiFi-tilknytning</b></p>
----	---------------	--	--

**HENVISNING:**

	<p><b>BEMÆRK:</b></p> <p>Alle monitorer og dør-videomoduler vises enkeltvist i netværket og har egen IP-adresse. Her har det ingen betydning, om systemerne tilsluttes via PoE-netværk eller i forbindelse med den 2-trådede variant til den "2-trådede fordeler". Monitoren "TVHS20200 / TVHS20220" kan desuden integreres i netværksstrukturen via WLAN.</p>
---	--

	<p><b>BEMÆRK:</b></p> <p>Hver terminalenhed skal forbindes direkte til distributionsenheden. Videreledning fra en skærm til den næste er ikke tilladt.</p>
---	--

## **4. Idriftsættelse**

### **4.1 *Kabelføring***

Detaljerede instrukser vedr. kabelføringen fremgår af de kvikguider, der følger med produkterne.

#### **4.1.1 *Installationshøjde***

Installationshøjden på videomodulet TVHS20000(S) eller TVHS20010(S) bør ikke være mindre end 1,40 m (øverste kant). Ellers kan det ske, at folk, der står for tæt på videomodulet, ikke kan genkendes af deres ansigt.



## 4.2 Aktiveringsmuligheder / første tildeling af kodeord

### 4.2.1 Aktivering via dørstationsmonitor

- 1) Etabler systemets strømforsyning, og kontroller, at dørstationen ligeledes befinder sig i det samme netværk.

Tildel et kodeord ved den første opsætning af monitoren. Dette kodeord bruges ligeledes automatisk til aktiveringen af dørstationen. Kodeordet skal også bruges til monitorens kodeordsbeskyttede område.

- 8-16 tegn
- Gyldige tegn: Tal, små bogstaver, store bogstaver, specialtegn ( ! \$ % & / ( ) = ? + - )
- der skal bruges 2 typer tegn

- 2) Vælg det ønskede sprog, og bekræft med tasten "FORTSÆT".

	Assistent sprog 1/4
English	
Deutsch	
Italiano	
Français	
Hollandske	

	<b>Firmware udgivelsesnote</b> Funktion: Hollandsk Videomodul (THVS20000(S) / TVHS20010(S)): V2.2.3_build_201029 Skærm (TVHS20200 / 210 / 220): V2.1.2_build_201029
---	--



- 3) Vælg nu mellem DHCP / fast IP-adresse. Det anbefales på det kraftigste, at hver enkelt enhed tildeles en fast IP-adresse, da der ellers under visse omstændigheder tildeles en ny IP-adresse ved strømsvigt, hvilket kan føre til alvorlige problemer i systemet.

	Assistent-netværk 2/4
DHCP	<input type="checkbox"/>
Lokal IP	192.168.0.11

Subnetmaske	255.255.255.0
Gateway	192.168.0.1

	<p><b>Bemærk</b></p> <p>Når du trykker på kontakten for DHCP-funktionen, springer kontakten først til højre og derefter til venstre igen. I dette øjeblik opnås en IP-adresse fra DHCP-serveren, som derefter indstilles som en fast IP-adresse i enheden.</p>
---	--

4) Vælg den type monitor, som du ønsker at opsætte.

	Assistent-netværk 3/4	
Indendørsstation type	Indendørsstation	
Etage	0	
Lejlighedsnr.	1	

#### Indendørsstation:

Monitoren bliver hovedmonitoren for et dørsamtaleanlæg. Her har det ingen betydning, om der opsættes et enfamilies- eller et flerfamilieshus. En lejligheds hovedmonitor skal altid opsættes med typen "indendørsstation". Hvis du kun bruger én ringeklokke og én lejlighed, bliver lejlighedsnummeret stående på "1". Når der bruges flere lejligheder / hovedmonitører, skal lejlighedsnumrene tilpasses.

Eksempel: Lejlighed 1 => lejlighedsnummer 1  
Lejlighed 2 => lejlighedsnummer 2  
(osv...)

Kun på den måde kan ringeklokkerne tildeles de forskellige parter.

**Bemærk:** En hovedmonitoren (indendørsstation) skal altid forbindes med hoveddørstationen i systemet.

#### Indendørsudvidelse:

Monitoren bruges som udvidelsesmonitor i et system for at udstyre andre rum i et hus. Alle udvidelsesmonitører tilknyttes hovedmonitoren og viser de samme funktioner som hovedmonitoren, når der ringes på døren.



Du kan knytte maks. 5 ekstra monitører til en hovedmonitor. (Nr. 1-5). Der kan desuden tildeles et "værelsesnavn". Dette vises automatisk under "kontakter" på de andre monitører i systemet.

**Bemærk:** En udvidelsesmonitor (indendørsudvidelse) skal altid forbindes med hovedmonitoren i systemet!

Ved installationstypen "indendørsudvidelse" står følgende menupunkter til rådighed på monitoren. **Disse kan kun indstilles/åbnes på systemets hovedmonitor:**

- Slå "automatisk modtagelse af opkaldet" via telefonsvareren til/fra.
- Aflyt beskeder fra telefonsvareren
- ABUS LINK Station app – Menu
- Tilføj netværkskameraer
- Konfiguration af netværksadresse og indstilling af fabriksindstillinger på slutudstyr

5) "Assistent-forbundet udstyr"

Assistent-forbundet udstyr				
Søg efter serienummer				
ABUS artikelnummer	IP-adresse	Firmwareversion	Aktivér	
				
ABUS artikelnummer	IP-adresse	Firmwareversion	Aktivér	
				
ABUS artikelnummer	IP-adresse	Firmwareversion	Aktivér	
				

Her ses det tilgængelige netværksudstyr i TVHS20xxx dørstations-serien.

Hvis en hovedmonitor skal opsættes, skal hoveddørstationen vælges her.  
Hvis en indendørsudvidelse skal opsættes, skal hovedmonitoren vælges her.

Her kan du ligeledes "aktivere" dørstationen. Hovedmonitoren aktiverer derefter automatisk den dørstation, der har samme kodeord som monitoren.

Vælg hoveddørstationen i listen, og klik på "Aktivér". Efter aktiveringen skal du vælge dørstationen. Der vises et grønt bekræftelsesflueben ved venstre side af listen. Dørstationen er nu aktiveret og forbundet.

Hvis der ikke er fundet noget udstyr i netværket, skal du kontrollere, at dørstationen befinder sig i samme netværk og forsynes med strøm.

Udstyrets IP-indstillinger åbnes med det relevante "tandhjul". På den måde kan dørvideomodulets IP-adresse tilpasses.

Hvis du vil tilføje andre sideindgange ud over én dør, skal du skifte til kapitel "9.2 Opsætning sideindgange" under Instrukser til installation og ibrugtagning.

#### **4.2.2 Aktivering via IP-netværk**

Installer og start ABUS IP Installer, som findes på ABUS' hjemmeside [www.abus.com](http://www.abus.com) under det enkelte produkt.

Alt forbundet udstyr skulle nu komme frem på listen, eventuelt endnu ikke med den IP-adresse, der passer til destinationsnetværket.

Som det første skal udstyret aktiveres, dvs. der skal tildeles et sikkert kodeord til hovedbrugeren "admin". Et sikkert kodeord skal opfylde mindst følgende krav:

- 8-16 tegn
- Gyldige tegn: Tal, små bogstaver, store bogstaver, specialtegn ( ! \$ % & / ( ) = ? + - )
- Der skal bruges mindst 2 typer tegn

Kameraet IP-indstillinger kan ændres via IP Installer.

Knappen "Browser" står ikke til rådighed blandt dørsamtaleanlæggets komponenter, da disse ikke har deres egen webserver.

Programmeringen af komponenterne kan i høj grad foretages via dørsamtaleanlæggets monitor. For mere komplekse systemopbygninger er det dog nødvendigt med en programmering via CMS-softwaren (integrering af en komponent som IP-udstyr, åbn menupunktet "Fjernkonfiguration").





	Aktiveringen i IP-netværket kan ligeledes foretages via ABUS CMS-softwaren.
	ABUS CMS-softwaren er ligeledes nødvendig til visse avancerede opsætningstrin.

#### **4.2.3 Nulstilling af kodeord monitor/video-dørmodul**

Hvis du ønsker at nulstille kodeordet til monitor eller video-dørmodul, bedes du kontakte vores tekniske support.

## 5. Betjening af monitoren (2-trådet og IP)

### 5.1 Livebillede

Knap / visning	Beskrivelse
	Besvarer opkaldet og åbner video-/taleforbindelsen.
	Afslutter opkaldet og lægger på.
	Gemmer et snapshot af det aktuelle videobillede
	<p>Åbner dørene. Hvis der bruges flere relæudgange på samme tid, er der op til 3 nøglesymboler. (2x dørrelæ i dør-videomodul, 1x dørrelæ på monitor).</p> <p>Hjælp til tilslutning af en døråbner til relæet eller til anvendelse af sikkerhedsmodul TVHS10040 findes i afsnit <u>Instrukser til installation og ibrugtagning</u> i kapitel "9.8 Tilslutning af elektrisk døråbner til videomodul (inkl. "havelåge")" og "9.1 Brug sikkerhedsmodul (TVHS10040/TVHS20340)"</p>

## 5.2 Hovedside oversigt

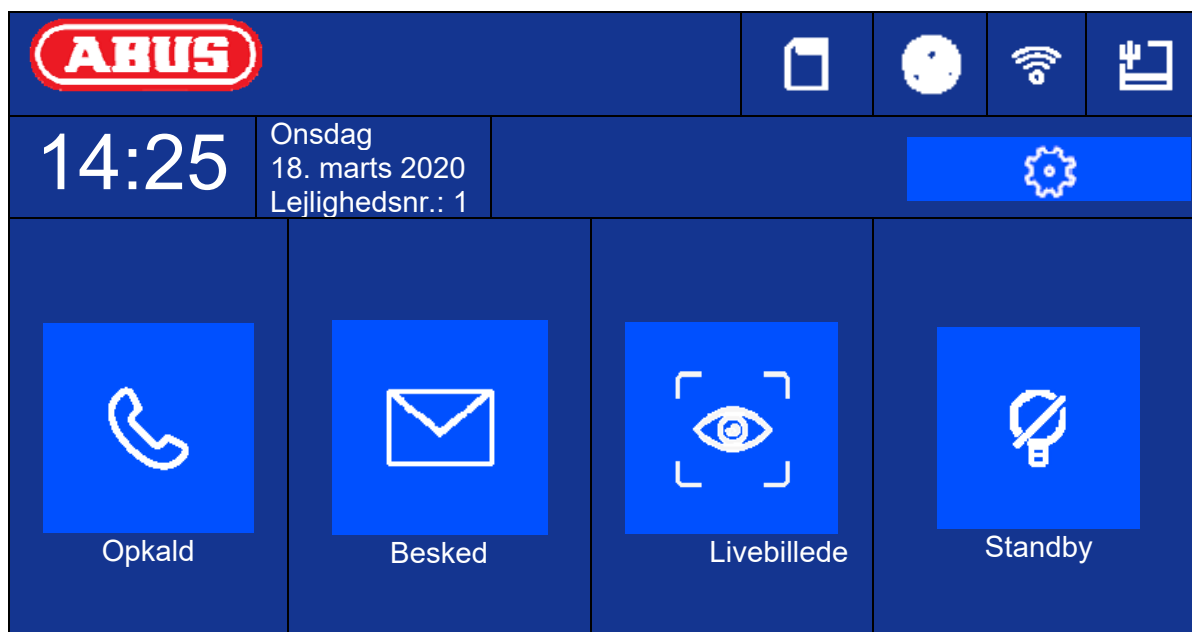

















Knap / visning	Beskrivelse
Klokkeslæt	Visning af klokkeslæt  Ved at trykke én gang på visningsfeltet åbnes dialogen til indstilling af dato og klokkeslæt.
Ugedag / dato	Visning af den aktuelle ugedag Visning af datoen
Lejlighedsnummer	Visning af det konfigurerede lejlighedsnummer for denne indendørsstation. Der er mulighed for maks. 49 lejligheder pr. system.
[ Opkald ]	Etabler samtale til indendørsstationen eller indendørsudvidelsen.  Vis / administrer kontakter  Se opkaldsprotokol (inkl. informationer om ringestation, enkeltbillede, dato og klokkeslæt)
[ Besked ]	Informationer om bemærkninger, meddelelser fra besøgende og enkeltbilleder fra svarene
[ Livebillede ]	Vis livebillede fra tilsluttede dørstationer samt konfigurerede netværkskameraer
[ Indstillinger / tandhjul ]	Generelle opkaldsindstillinger: Ringetone, ringetonens varighed, opkaldets varighed, omstilling af opkaldet, mikrofonens lydstyrke, ringetonens lydstyrke, samtalens lydstyrke, tastetonen, automatisk modtagelse af opkald, forstyr-ikke-modus  WLAN-indstillinger for monitoren (må kun bruges ved IP-varianten!)

	Andre udstyrsindstillinger: Konfiguration (system), relæets reaktion, microSD-kort, klokkeslæt, skærmens lysstyrke.
[ Standby ]	Deaktiver straks skærmen







## Opkald

Start opkald mellem lejligheder eller udvidelsesmonitorer. Her kan der ligeledes oprettes kontakter. Der oprettes automatisk en indendørsudvidelse.

	*Indtast telefonnummer (0-0 for indendørsstation, 0-1 indendørsstation udvidelse nr. 1)				
					
					
					

## Kontaktliste

















Her kan du redigere eller slette oprettede brugere. Tryk på kontaktlinjen i 3 sekunder for at slette. Derefter vises en menu til sletning af kontakter.

	Kontaktliste		
Room 1			
			
			





## Opkaldsprotokol

Viser de indgående opkald / når der ringes på døren. Desuden kan man få direkte adgang til et snapshot.





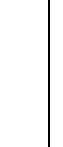

	Opkaldsprotokol			
	Hoved-dørstation		14-03-2020 11:21:08	
	Hoved-dørstation		14-03-2020 10:55:37	
	Hoved-dørstation		14-03-2020 10:55:37	
	Hoved-dørstation		14-03-2020 10:55:37	
	Hoved-dørstation		14-03-2020 10:55:37	
	Hoved-dørstation		14-03-2020 09:55:37	

## Bemærk

	Bemærk		
Ingen henvisning	...		
			
			













## Meddelelser fra besøgende (telefonsvarer)

Her kan du, hvis funktionen er tilgængelig og aktiveret, aflytte lydbeskederne fra telefonsvareren.



















<		Meddelelser fra besøgende		
Nr.1			14-03-2020 10:47:35	    
Nr.2			13-03-2020 14:47:39	
Nr.3			13-03-2020 14:26:06	
				

### Optagelsesprotokol

Her finder du en oversigt over billeder sorteret efter dage

<		Optagelsesprotokol			
14-03					    
					
					
					

### 5.2.1 Menupunkt: Opkaldsindstillinger

<	Opkaldsindstillinger				
Ringetone	Ringetone 6	>			
Aktiver ringetone	<input type="checkbox"/>				
Ringetonens varighed		30 s			
Opkaldets varighed		30 s			
Omstilling af opkaldet		0 s			
Mikrofonlydstyrke		10 %			
Ringetonens lydstyrke (monitor)		70 %			
Samtalens lydstyrke		10 %			
Tastetone	<input type="checkbox"/>				
Automatisk modtagelse af opkald	<input type="checkbox"/>				
Umiddelbar automatisk accept	<input type="checkbox"/>				
Forstyr-ikke-modus	Indendørsstation	>			
Forstyr ikke	Hele dagen	>			

Knap / visning	Beskrivelse
Ringetone (1~6):	Vælg mellem de 6 standardringetoner.
Aktiver ringetone:	Her kan du aktivere eller deaktivere ringetonen.
Ringetonens varighed (1~60 s):	Bestemmer ringetonens varighed ved et indgående opkald. Efter den definerede tid deaktiveres ringetonen automatisk. Opkaldet er fortsat aktivt.
Opkaldets varighed (1~60 s):	Bestemmer opkaldets varighed. Efter den indstillede tid afsluttes det indgående opkald automatisk.
Omstilling af opkaldet (0~20 s):	Omstilling af opkaldet forsinket opkaldet til ABUS Link Station appen. Eksempel: 10

	sekunder. Når der er ringet på døren, ringer dørstationens monitor omgående, men der ringes til ABUS Link Station med en forsinkelse på 10 sekunder.
Mikrofonens lydstyrke (0~100 %):	Indstil her mikrofonens lydstyrke på monitoren. Jo flere procent, jo højere (følsommere) er mikrofonen på monitoren.
Ringetonens lydstyrke (monitor) (0~100 %):	Indstil her ringetonens lydstyrke på monitoren.
Samtalens lydstyrke (10~100 %):	Indstil her den ønskede samtalelydstyrke på monitoren
Tastetone:	Aktiver tastetonen ved at trykke på monitorens touchskærm.
Automatisk modtagelse af opkald:	Hvis funktionen er aktiveret, accepterer dørtelefonsystemet opkaldet med telefonsvareren, efter at opkaldet er udløbet (ringetiden).
Umiddelbar automatisk accept	Når funktionen er aktiveret, tager dørsamtaleanlægget automatisk mod opkaldet med det samme via telefonsvareren, når det ringer på døren.  Når funktionen er deaktiveret, vil telefonsvareren automatisk tage mod opkaldet efter den indstillede opkaldsvarighed.
Forstyr-ikke-modus:	Indendørsstation: Opkald fra dørstationer og udvidelsesmonitører tilladt. Opkald fra andre lejligheder tillades ikke. For at tillade opkald fra lejligheder skal funktionen "Forstyr ikke" sættes på "Deaktiveret".  Alle: Alle opkald afvises. (Opkald fra dørstation, udvidelsesmonitor eller anden lejlighed)
Forstyr ikke:	Deaktiveret, hele dagen, tidsplan (dagligt fra-til time/minut). Bestemmer, i hvilken periode funktionen "Forstyr ikke" er aktiv.







	<p><b>Firmware udgivelsesnote</b></p> <p>Funktion: Autosvar, Øjeblikkelig autosvar  Videomodul (THVS20000(S) / TVHS20010(S)): V2.2.3_build_201029  Skærm (TVHS20200 / 210 / 220): V2.1.2_build_201029</p>
---	---

Hvis du fortsat vil bruge en (allerede eksisterende) ringeklokke / dørklokke, skal du gå til kapitel "9.5 Tilslutning af en eksisterende dørklokke" i afsnittet Instruksér til installation og ibrugtagning.

For at få informationer om ændring af lydstyrken fra video-dørmodulet skal du gå til kapitel "9.4 Indstilling af lydstyrke på dør-videomodulet (TVHS20000, TVHS20010)".

For at indstille dine egne ringetoner i monitorerne skal du gå til kapitel "9.9 Tilpasning af egne ringetoner på dørstationens monitor".

## 5.2.2 WLAN-indstillinger

	WLAN-indstillinger		
			
MAX_MUSTERWLAN			
			

Knap / visning	Beskrivelse
Aktivering/deaktivering	Aktivér/deaktivér monitorens WLAN-interface
WLAN-netværksliste	Her finder du de tilgængelige WLAN-netværk i nærheden af dig. Hvis du vælger en registrering, opfordres du til at indtaste kodeordet til WLAN. Når forbindelsen er etableret, vises et grønt bekræftelsesflueben i listen foran det valgte netværk.
W-LAN Info Icon	Her ser du WLAN-parametrene som netværksnavn, signalniveau og IR-parametre.  Hvis du klikker på "AFBRYD", afbrydes monitoren fra WLAN.

### 5.2.3 Etageaster

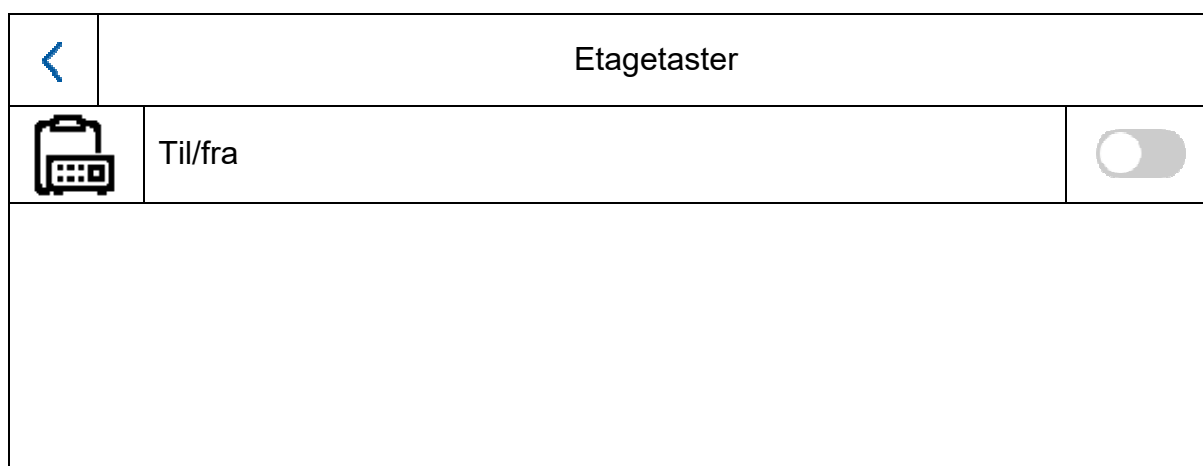











Etageasten tilsluttes direkte til monitoren via de kabelforbundne indgange og gør det muligt at ringe på direkte ved lejlighedens dør. Denne funktion bruges overvejende i flerfamiliehuse. Her er hoveddørstationen monteret fornedet ved hovedindgangen. Alle lejligheder har dog også en direkte ringeklokke ved lejlighedsdøren. Etageastens ringetone adskiller sig fra den normale ringetone fra video-dørmodulet.

Knap / visning	Beskrivelse
Linje 1 – linje 8	Beskriver, hvilken indgang på monitoren der bruges til etageasten. Normalt bruges indgang 1 (linje 1).
NO / NC	Normally Open / Normally Closed. Her bestemmes det, om ringeklokken ved lejlighedsdøren er en åbner- eller en lukkerkontakt. Som regel er det en "NO"-kontaktafbryder.

Du finder yderligere informationer i afsnittet [Instrukser til installation og ibrugtagning](#) i kapitel "9.7 Tilslutning af etageringeklokker til hovedmonitoren".

## 5.2.4 Øvrige indstillinger

### 5.2.4.1 Konfiguration – Lokale informationer

	Lokale informationer			
Lejlighedsnr.			1	
Livebilledets varighed		30 s		
Indstillinger ABUS Link Station-tjenesten				
Synkronisering af tid				
Sommertid				
Assistent				

Dette område er beskyttet med kodeord. Indtast kodeordet til første opsætning.

**Bemærk:** Ved installationstypen "indendørsudvidelse" står følgende menupunkter til rådighed på monitoren. **Disse kan kun indstilles/åbnes på systemets hovedmonitor:**

- Slå "automatisk modtagelse af opkaldet" via telefonsvareren til/fra.
- Aflyt beskeder fra telefonsvareren
- ABUS LINK Station app – Menu
- Tilføj netværkskameraer
- Konfiguration af netværksadresse og indstilling af fabriksindstillinger på slutudstyr

Installationstype:

Valgmuligheder: Indendørsstation, indendørsudvidelse

**Indendørsstation:** Dørsamtalsystemets monitor inden for en lejlighed

**Indendørsudvidelse:** maks. 5 yderligere monitorer kan forbindes i en lejlighed

Eksempel: Videomodul + indendørsstation + 5 indendørsudvidelser

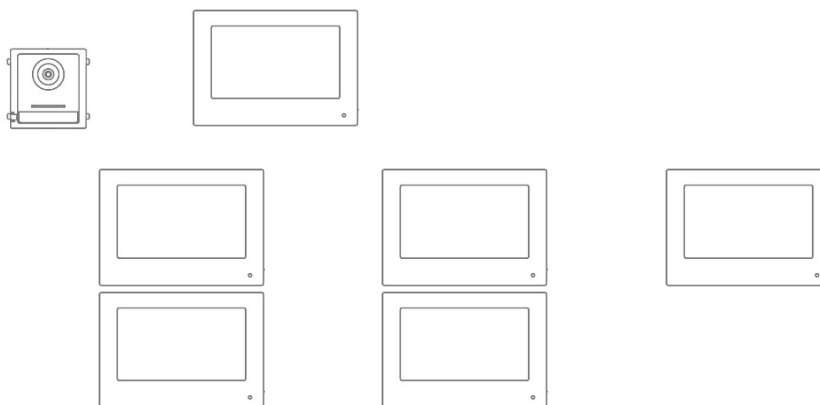

Lejlighedsnr.: Dette er det maksimale antal indendørsstation-monitorer, der kan forbindes med 8 ringeklokkeudvidelser via et dør-videomodul. Dette maks. antal er på 49 indendørsstation-monitorer eller 49 lejligheder.



Kun ved indstilling "*Indendørsudvidelse*":

Nr. (1~5): Konfiguration af nummeret på indendørsudvidelsen. Der er mulighed for maks. 5 udvidelsesmonitorer.

Værelsesnavn: Betegnelse for det rum, hvor udvidelsesmonitoren befinder sig.

Livebilledets varighed (10~60 s): Varigheden af visningen af det manuelt rekvirerede livebillede fra et dør-videomodul eller tilsluttet IP-kamera. (kan åbnes via hovedside / livebillede)

Du finder informationer vedr. opsætning af flere ringeklokker i flerfamilieshuse i afsnittet Instrukser til installation og ibrugtagning i kapitel "9.3 Opsætning af udvidede ringeklokker (TVHS20020) til flerfamilieshus".

### **Indstillinger ABUS Link Station tjenesten:**

ABUS Link Station funktionen bruges til enkel opsætning og tilslutning af en smartphone app med dørsamtale-systemet. Der kræves kun få trin. Der skal være en aktiv internetforbindelse til dørstationen.

Denne menu findes kun på en monitor med indstillingen "indendørsstation" (hovedmonitor).



Aktivér denne funktion, hvis du vil bruge app-adgangen på dørsamtaleanlægget.

#### Fremgangsmåde:









1. Installér ABUS Link Station appen (lite/pro) (Android/iOS)
2. Klik i appen på "Tilføj udstyr" og "Scan QR-kode".
- 3 Scan QR-koden, som er vist på indstillingssiden til ABUS Link Station. Alle indendørsstations-monitorer har deres egen QR-kode.
4. Under opsætningen skal verificeringskoden indtastes. Denne kan også ses på opsætningssiden og kan ændres efter ønske.

En QR-kode kan kun føjes til en ABUS Link Station konto. Andre konti kan have adgang til dørsamtaleanlægget via aktivering.



	Indstillinger ABUS Link Station-tjenesten	
Aktivér ABUS Link Station		
Verifikationskode	xxxxx	
ABUS Link Station serverstatus	Forbundet	
		









Synkronisering af tid:                   Aktivér tidsindstillingen via NTP-protokollen. Intervallet bestemmer opdateringsfrekvensen i minutter. Feltet IP-adresse giver mulighed for indtastning af en NTP-serveradresse eller en IP-adresse. Portnummeret er fastlagt til 123 (standardport til NTP-protokollen.) Vælg tidszonen, hvor dørsamtaleanlægget befinder sig (normalt GMT+01:00)

	Tidssynkronisering		
 Aktivér NTP			
Synkroniser interval	60		
IP-adresse	ntp.org		
Port-nr.	123		
Tidszone	(GMT+1:00 Amsterdam, Berlin, Rom, Paris		
			

	<p>Når du bruger ABUS Link Station-tjenesten i forbindelse med push-funktionen til et klokkeopkald, skal NTP-funktionen være aktiveret og korrekt konfigureret.</p> <p>Sørg for at bruge den korrekte NTP-serveradresse "0.pool.ntp.org".</p>
---	---

Sommertid:

Indtastning af detaljer vedr. skift mellem sommertid og normaltid.

	Sommertid		
	Aktiver sommertid		
Starttidspunkt	Marts sidste uge søndag 2:00		
Sluttidspunkt	Oktober sidste uge søndag 3:00		
Forskydning	60 min.		
			





Assistent:

Genstart af installationsassistenten. Følgende trin gennemgås ved assistenten:

- a) Sprogindstilling
- b) Netværksindstilling (trådforbundet interface)
- c) Monitoren installationstype eller funktionsmåde (indendørsstation eller indendørsudvidelse) og lejlighedsnummer
- d) Udstyrets forbindelse til monitoren.
  - Hvis indendørsstation-> tildeling af et dør-videomodul
  - Hvis udvidelse -> Tildeling af en hovedmonitor (indendørsstation)







### 5.2.4.2 Konfiguration – netværksindstillinger

Denne menu beskriver indstillingerne til de trådforbundne netværksinterfaces

Netværksindstillinger		
 DHCP	<input type="checkbox"/>	
Lokal IP	192.168.0.11	
Subnetmaske	255.255.255.0	
Gateway	192.168.0.1	
DNS-adresse	192.168.0.1	
DNS-adresse 2	194.25.2.129	

Knap / visning	Beskrivelse
DHCP	Slå DHCP til/fra. Det anbefales på det kraftigste at indstille alle dørsamtalsystemets komponenter på en fast IP-adresse.
Lokal IP	Indstil her den lokale IP for udstyret
Subnetmaske	Indstil her subnetmasken for udstyret
Gateway	Indstil her gatewayen for udstyret. Normalt bruges routerens IP her.
DNS-adresse	Indstil udstyrets DNS-adresse her. Normalt bruges routerens IP her.
DNS-adresse 2	Indstil alternativt udstyrets DNS-adresse her. Normalt bruges routerens IP her.

### 5.2.4.3 Konfiguration – administration af udstyret

	Udstyrsadministration		
Hoved-dørstation	192.168.0.26		
			
			
			

Denne menus funktion adskiller sig grundlæggende mellem indendørsstation og indendørsudvidelse. Her kan du ændre udstyrets tildelinger.

#### Vigtigt:

Hovedmonitoren for et system skal altid knyttes til hoved-videomodulet.  
En udvidelsesmonitor for et system skal altid forbindes med systemets hovedmonitor.

Indendørsstation:     - Tildeling af hoved-dørstation  
                              - Tilføjelse af yderligere IP-netværkskameraer til en livevisning. For at gøre det skal du klikke øverst til højre på symbolet "+" og vælge "Privat protokol" for et ABUS netværkskamera.

Indendørsudvidelse:   - Tildeling af indendørsstation (hovedmonitor)

I denne menu kan du desuden udføre følgende interaktioner:

- Indstilling af dørstationernes netværksparametre (DHCP, IP-adresse osv.)
- Nulstilling af dørstationerne til fabriksindstilling

For at tilføje et ABUS netværkskamera til systemet skal du klikke på "+" symbolet øverst til højre under "Tilføj udstyr".

Vælg "Privat protokol" til ABUS kameraer, og tildel et valgfrit navn til udstyret. Desuden skal kameraets IP-adresse i netværket samt RTSP-porten (standard 554) bruges til integreringen. Til sidst skal du igen indtaste brugernavnet og kodeordet til dit netværkskamera.

Listen over kompatible ABUS netværkskameraer findes på [www.abus.com](http://www.abus.com).

### Indstilling af netværksparametrene for videodørmodulet

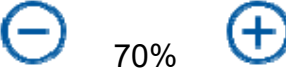
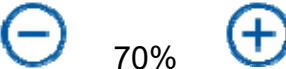
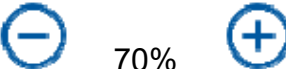
Indstillinger for dørstation	
192.168.0.26	
255.255.255.0	
192.168.0.1	
DHCP	
Mikrofonlydstyrke	
Lydstyrke til ringetone	
Opkaldslydstyrke	
Abort	OK

**Linjer 1 -3:**

IP-adresse, gateway og undernetmaske

**DHCP:**

Når der trykkes på knappen, startes anmodningen om IP-adressedata fra DHCP-serveren. Afbryderen går derefter tilbage til venstre. De modtagne IP-adressedata indstilles derefter som faste data. Der er ingen yderligere automatisk forespørgsel om dataene.

**Mikrofonlydstyrke:**

Indstilling af mikrofonens følsomhed i videodørmodulet

**Lydstyrke for ringetone:**

Indstilling af lydstyrken for ringetonen efter at have trykket på bjælken på videodørmodulet

**Opkaldslydstyrke:**

Indstilling af lydstyrken under et opkald på videodørmodulet

Udfører en nulstilling til fabriksindstillingerne for videodørmodulet

Alle indstillinger for videodørmodulet kan nulstilles her via hovedskærmen.









Gendanne alle standardparametre?	
Abort	OK

#### 5.2.4.4 Konfiguration – standardindstillinger

**Standardindstillinger:** Nulstiller monitoren til standardindstillinger. Aktivering/kodeord bevares.

**Fabriksindstillinger:** Nulstiller hele monitoren inkl. kodeord til fabriksindstillinger. Monitoren befinder sig derefter i "inaktiv" tilstand.

#### 5.2.4 Relækonfiguration

<		Relækonfiguration		
	Relæ 1			
Varighed			3 s	
Interval			5 s	
	Relæ 2			

Under "Relækonfiguration" konfigureres monitorens egne to relæer. Konfigurationen i denne menu har ingen påvirkning på video-dørmodulets relæer.

Relæudgangene sidder på monitorens bagside og kan tilsluttes via det medfølgende breakout-kabel. Placeringen er trykt på bagsiden af monitoren.

**Relæ 1** sættes mellem COM1 og NO1, **relæ 2** tages ud ved COM2 og NO2.

Knap / visning	Beskrivelse
Relæ 1	Aktiverer / deaktiverer funktionen på en ekstra (eller allerede eksisterende) ringeklokke. Relæ 1 på monitoren udløses parallelt med et opkald.
Varighed	Bestemmer varigheden for, hvor længe relæet til den ekstra dørklokke udløses, når der ringes på døren.
Interval	Bestemmer intervallet, i hvilket relæet udløser den ekstra dørklokke, når der ringes på døren, i den indstillede "varighed".
Relæ 2	Aktiverer / deaktiverer den ekstra udgang på monitoren (f.eks. til en døråbner på lejlighedsdøren på den enkelte etage). Når funktionen er aktiveret, vises endnu et "nøglesymbol" med påskriften "3" på den lokale monitor.

For yderligere informationer læs kapitel "9.6 Tilslutning af eksisterende døråbner på dørstationens monitor" og "9.5 Tilslutning af en eksisterende dørklokke" i afsnittet Instrukser til installation og ibrugtagning.

Her finder du ligeledes informationer om følgende emne: "9.8 Tilslutning af elektrisk døråbner til videomodul (inkl. "havelåge")"

### 5.2.5 *microSD-kort*

Knap / visning	Beskrivelse
Formatering	<b>Vigtigt!</b> Hele microSD-kortet formateres, og dataene på det slettes.
Afinstallering	Deaktiverer microSD-kortet, derefter finder der ingen optagelse sted. Du kan tage microSD-kortet ud uden problemer.

### 5.2.6 *Spærring af skærm*

Spærrer skærmen i 30 sekunder. I denne periode kan touchpanelet deaktiveres og evt. rengøres

### 5.2.7 *Informationer om udstyret*

Her finder du monitorens firmwareversion samt model og serienummer på dit udstyr. Vedr. vejledning om opdatering bedes du gå til kapitel "ABUS CMS-software: Firmwareopdatering" i afsnittet Instrukser om installation og ibrugtagning.

### 5.2.8 *Tidsindstilling*

Her kan du indstille monitorens klokkeslæt/dato manuelt. Alternativt kan du klikke direkte på klokkeslættet på hovedskærmen.

### 5.2.9 *Genstart udstyr*

Genstarter monitoren.

## 5.2.10 Kodeordsindstillinger (PIN-KODE)

### PIN-tildeling til tastatur TVHS20030

	Kodeordsindstillinger	
PIN-kode		 

Bemærk: Her har du brug for tastaturet til indtastning af PIN-KODE TVHS20030(S).

Her kan du indstille en 6-cifret nøgle, som så gælder for åbning af døre via tastaturet. PIN-koden er altid 6-cifret.

Tryk følgende kombination for at indtaste PIN på tastaturet:

Op til firmware V2.0.8 / V2.1.2 build 200410:

"#" 6-cifret PIN "#". Eksempel: # 123456 #

Fra firmware V2.2.3 / V2.1.2 build 201029:

"#" Lejlighedsnummer 6-cifret PIN "#". Eksempel: # 1123456 #

- dvs. fra denne firmware kan PIN-koden indstilles individuelt for hver lejlighed.
- Det er nu muligt at ændre og slette lejlighedsafhængige PIN-koder

Lokalt på monitoren kan der indtastes **en** PIN-KODE. **Tre** yderligere koder kan indtastes ABUS CMS-softwarens fjernkonfiguration. Der står altså maks. 4 forskellige PIN-koder til rådighed. For at tilføje en kode via ABUS CMS-softwaren skal du åbne dør-videomodulets fjernkonfiguration og vælge menupunktet "Intercom" og "Permission password". PIN-koderne gemmes generelt i videomodulet og ikke i tastaturet.



## Remote Configuration

The screenshot shows a web-based configuration interface. On the left is a navigation menu with categories: System (Device Information, General, Time, System Maintenance, User, RS485), Intercom (ID Configuration, Time Parameters), Permission Password (selected), and Access and Elevator Control. The main content area is titled 'Configuring the Right and Password Parameters' and contains a 'Permission Password' section with the following fields: Password Type (dropdown menu set to 'PublicPassword1'), Old Password (text input), New Password (text input), and Confirm Password (text input). A 'Save' button is located below the Confirm Password field.

### 5.2.11 Systemsprog

Vælg det ønskede sprog.

### 5.2.12 Indstilling af lysstyrke

Her kan du indstille monitorens lysstyrke i området fra 0 - 100 %.

### 5.2.13 Etagetaster

Aktiverer eller deaktiverer etagetaster-funktionen. Når funktionen er aktiveret, vises der på højre side endnu et menupunkt under "WLAN"-symbolet. Nu står etagetaster-funktionen til rådighed og kan bruges via monitorens kabelforbundne indgange. Du finder ydeligere forklaringer i "9.7

Tilslutning af etageringeklokker til hovedmonitoren" i afsnittet Instrukser til installation og ibrugtagning

### 5.2.14 Open Source licensinformationer

Læs Open Source licensinformationerne i slutningen af dette dokument.

## 6. Vedligeholdelse og rengøring

### 6.1 Funktionstest

Kontrollér regelmæssigt produktets tekniske sikkerhed, f.eks. beskadigelse af huset.

Hvis det må antages, at drift ikke længere er mulig uden farer, skal produktet tages ud af drift og sikres mod utilsigtet drift.

Det må antages, at drift ikke længere er mulig uden fare, hvis

- Udstyret har synlige skader
- Udstyret ikke længere fungerer
- Udstyret har været opbevaret i længere tid under ugunstige forhold
- Udstyret har været udsat for belastninger under transporten



#### **Vær opmærksom på følgende:**

Produktet er vedligeholdelsesfrit for dig. Der er ingen dele inde i produktet, som du skal kontrollere eller vedligeholde – åbn det aldrig.

### 6.2 Rengøring

Rengør produktet med en ren, tør klud. Ved kraftigere tilsmudsninger kan kluden fugtes let med lunkent vand.



Sørg for, at der ikke kommer væsker ind i apparatets indre. På den måde ødelægges udstyret. Anvend ikke kemiske rengøringsmidler. På den måde kan husets overflade blive angrebet.

## 7. Bortskaffelse



Udstyr med dette mærke må ikke bortskaffes sammen med husholdningsaffaldet. Bortskaf produktet iht. de gældende lovmæssige bestemmelser, når dets levetid er afsluttet. Kontakt din forhandler, eller bortskaf produkterne hos den kommunale genbrugsstation for el-skrot.

## 8. Open Source licenshenvvisninger

Produktet indeholder softwarekomponenter, der er licenseret af rettighedsindehaverne som gratis software eller open source-software (i det følgende benævnt "OSS"). De tilsvarende licenser er vedlagt produktet i trykt form og / eller kan fås adgang via en grafisk brugergrænseflade. Du kan erhverve brugsrettigheder i det omfang, der er reguleret der direkte fra rettighedsindehaverne. Open source-licenser har forrang for alle andre licensbetingelser og kontraktlige aftaler med ABUS i relation til de tilsvarende OSS-softwarekomponenter, der er indeholdt i produktet. Generelt kan licensoplysninger om ABUS-produkter findes på [www.abus.com](http://www.abus.com) i downloadområdet i produktbeskrivelsen.

## 9. Instrukser til installation og ibrugtagning

### 9.1 Brug sikkerhedsmodul (TVHS10040/TVHS20340)

Sikkerhedsmodul TVHS10040 (eller nyt artikelnummer TVHS20340) bruges til at placere døråbner-kontakten i det beskyttede indendørsområde og dermed beskytte den mod sabotage. Sikkerhedsmodul forsynes med 12 V-spænding og sættes fast på dør-videomodul med RS485-BUSSEN.

Brug 4-pin kablet, der følger med dør-videomodul. Dette kabel skal kobles fra på den ene side af stikket, og kablerne skal sluttes til sikkerhedsmodul. ID for DIP-kontakten på sikkerhedsmodul skal ikke bruges og er fortsat indstillet på standardværdien. (DIP-kontakt 1 aktiveret, DIP-kontakt 2/3/4 deaktiveret)

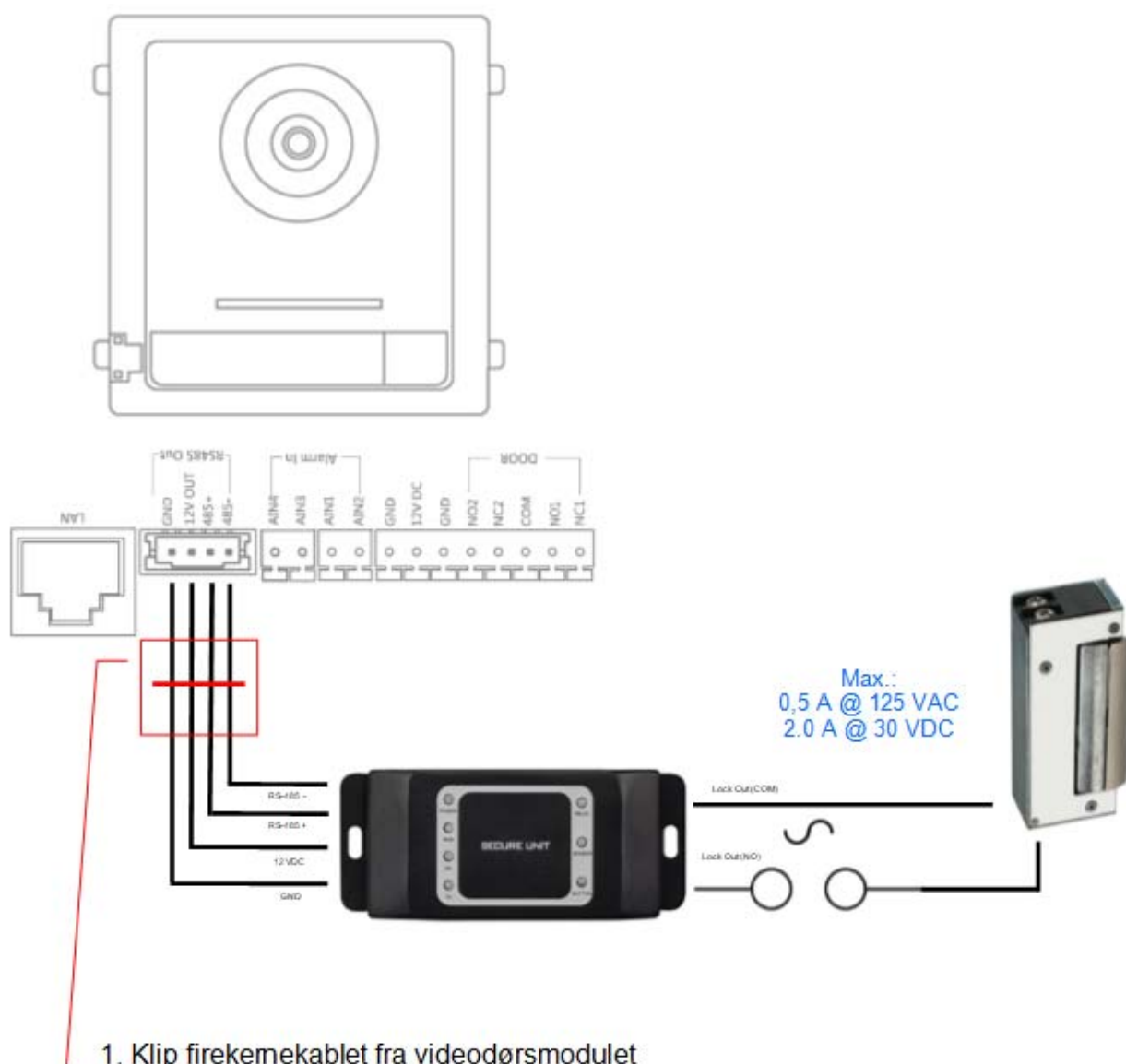

1. Klip firekernekablet fra videodørsmodul (leveringsomfang)

2. Tilslut de 4 ledninger med følgende farve til sikkerhedsmodul.



**Op til firmware V2.0.8 / V2.1.2 build 200410:**

Sikkerhedsmodul skal stadig konfigureres som et nyt dørrelæ. For at gøre dette skal du åbne dørvideomodulets fjernkonfiguration med ABUS CMS-softwaren og gå til menuen "Intercom" / "IO In Out" og indstille "IO Out" til "DOOR 1" til "securityModule"

**Fra firmware V2.2.3 / V2.1.2 build 201029:**

Efter tilslutning af sikkerhedsmodul genkendes det automatisk.

Nu aktiveres dør-videosamtalemodulets relæ ikke længere ved åbning af døren, men sikkerhedsmodulets relæ. Mens relæet er aktivt, lyser den grønne LED "Relay" på TVHS10040.

**Vigtigt:** Der kan kun bruges ét sikkerhedsmodul TVHS10040 pr. video-dørmodul!

**Bemærk:** Sikkerhedsmodul sættes altid på som sidste modul. Her har det ingen betydning, om der kun sættes ét video-dørmodul eller ekstra udvidelsesmoduler på.

Relæets belastningsevne: maks. 2 A 30 VDC / 0,5 A 125 AC

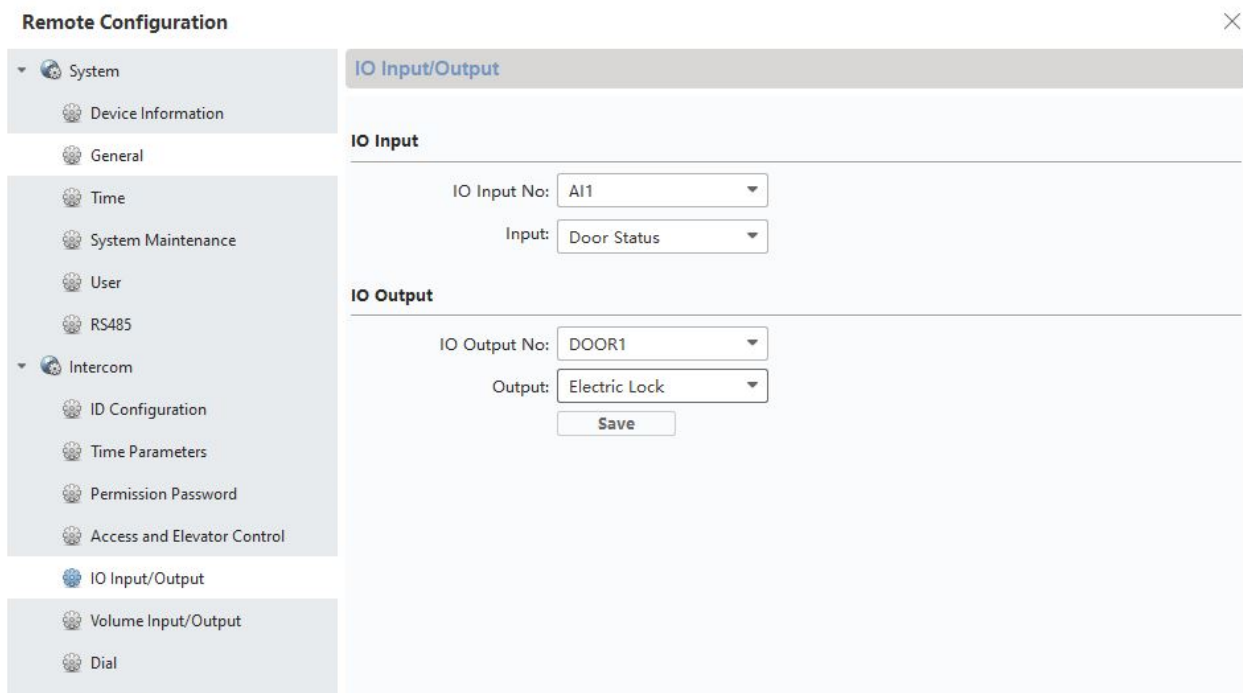

## 9.2 Opsætning sideindgange

Hvis du ønsker at integrere endnu et dør-videomodul (maks. 16) i systemet, f.eks. for at installere en sideindgang (f.eks.: varemodtagelse, kælderdøre osv.), skal du gøre følgende:

- 1) Forbind sideindgangens dør-videomodul med hoved-dørsamtaleanlæggets netværk. Alle dørsamtalestationens enheder skal befinde sig i det fysiske LAN.
- 2) Åbn ABUS CMS-softwaren, og aktiver sideindgangens dørmodul.
- 3) Tilføj sideindgangens dørsamtalemodul til ABUS CMS-softwaren, og åbn fjernkonfigurationen.
- 4) Under "Intercom" skal du nu skifte til "Room Number". Under "No.:" indtastes nu sideindgangens nummer. Hoved-dør-videomodulet skal have nummer "0". De ekstra sideindgange nummereres med 1-9. Undlad at ændre numrene "Period/Building/Unit eller Floor".

Efter lagringen genstarter systemet. Bekræft med "OK".

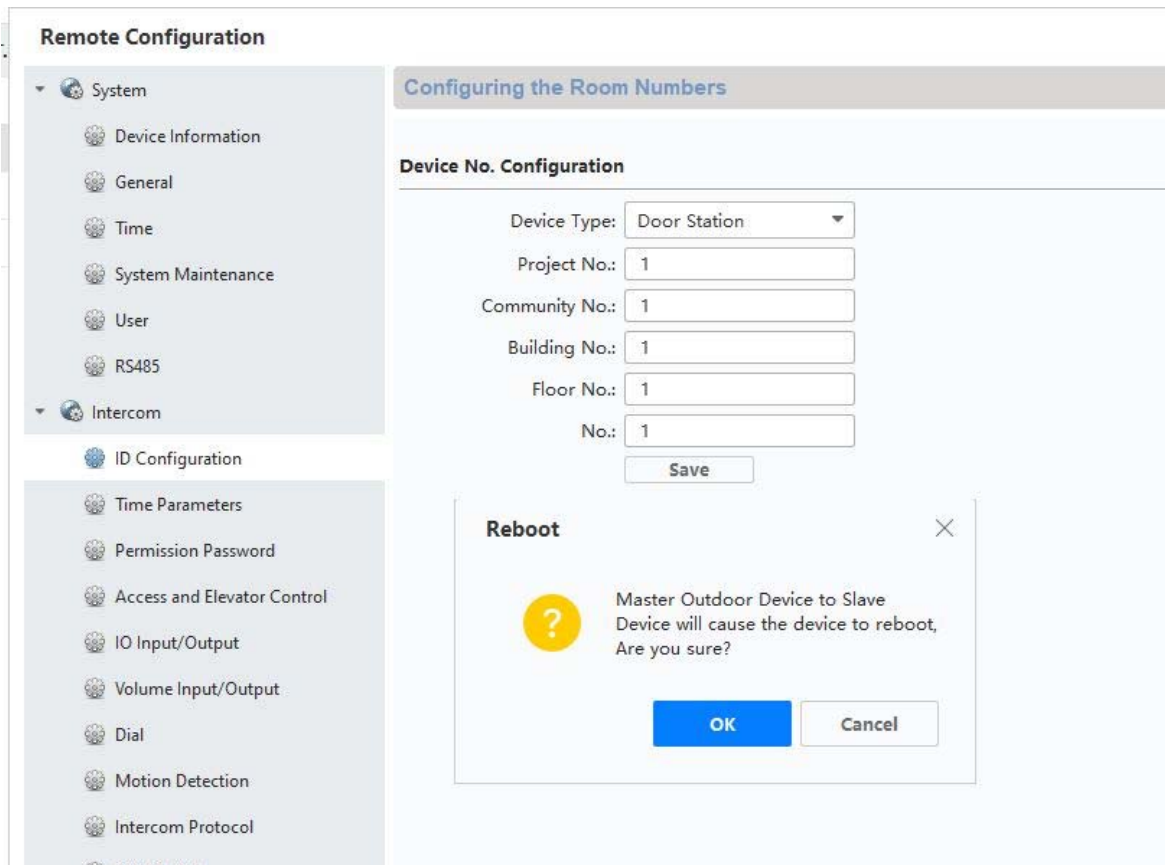

- 5) Efter gennemført genstart skal du tildele hoveddørene til sideindgangen. For at gøre det skal du på "Network" / "NetConfig SIP" på "(Main)Outdoor IP Address" indtaste og gemme hoved-dørstationens IP-adresse.

**Vigtigt:** Menuen "(Main) Outdoor IP Address" vises kun, hvis du har udført trin 4) korrekt.

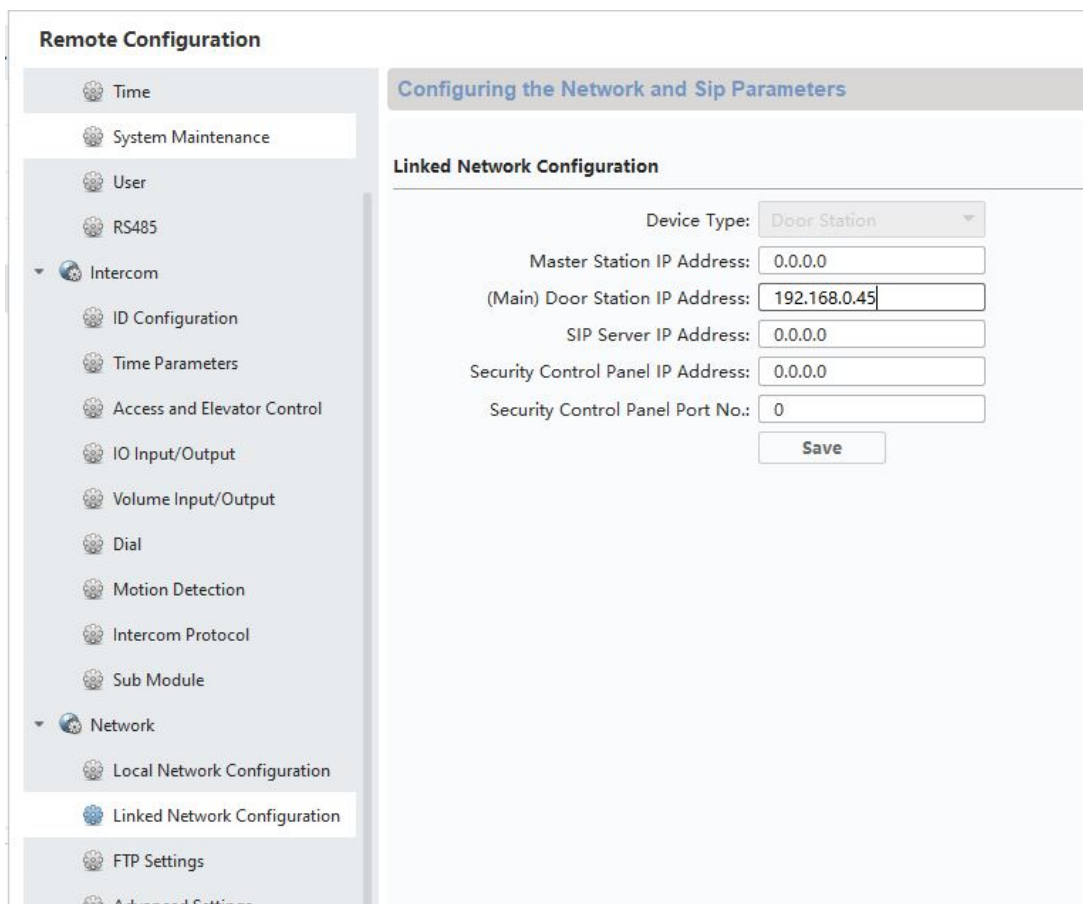

- 6) Opsætningen af sideindgangen er nu færdig. Når der nu ringes på ved en sideindgang, vises det også på monitoren, at opkaldet er startet fra en sideindgang. Under "LIVEBILLEDE" på monitoren er der nu også adgang til videobilledet fra sideindgangen, og dørene kan åbnes.

### 9.3 Opsætning af udvidede ringeklokker (TVHS20020) til flerfamilieshus

Via ekstramodulerne (TVHS20020) kan der installeres op til 49 ringeklokker til flerfamilieshuse. Udvidelsesmodulet sluttes til hoved-videomodulet via et forbindelseskabel.

Hvis der kun bruges ét ekstra ringeklokkemodul, kan installationen foretages uden ABUS CMS-softwaren.

Hoved-dørmodulet er klokken med "lejlighedsnummer 1". Udvidelsesmodulet TVHS20020 er automatisk indstillet på lejlighedsnummer 2 - 7. "Lejlighed" svarer her til hver enkelt lejlighed.

Hvis du ikke bruger hoved-videomodulets ringeklokke og lukker den med afdækningspladen, skal du konfigurere udvidelsesmodulet TVHS20020 via ABUS CMS-softwaren. På "Intercom" / "Submodule" (Undermoduler) finder du alle tilsluttede udvidelsesmoduler på RS-485 BUSSEN. (Undtagelse: Sikkerhedsmodulet TVHS10040 vises ikke her)

I menuen "Submode" skal du klikke på "Settings"-symbolet for at tildele lejlighedsnumrene.

Undermodulets ID afhænger af det indstillede ID via DIP-kontakten på bagsiden af udvidelsesmodulets hus. På den måde er det let at tildele det passende ved opbygning med flere udvidelsesmoduler.

**Vigtigt:** Efter ændring af ID via DIP-kontakten skal kablet tages kortvarigt ud af det enkelte udvidelsesmodul og genstartes.

The screenshot shows a 'Remote Configuration' window with a sidebar on the left and a main configuration area on the right. The sidebar contains a tree view of configuration categories: Time, System Maintenance, User, RS485, Intercom (expanded), and Network. Under 'Intercom', 'Sub Module' is selected. The main area is titled 'Configuring Sub Module Information' and contains a table with the following data:

Module A...	Module Type	Module Status	Module Version Settings
1	Keypad Module	Online	V1.0.0 ...d191009



**Remote Configuration**

- System
  - Device Information
  - General
  - Time
  - System Maintenance
  - User
  - RS485
- Intercom
  - ID Configuration
  - Time Parameters
  - Permission Password
  - Access and Elevator Control
  - IO Input/Output
  - Volume Input/Output
  - Dial
  - Motion Detection
  - Intercom Protocol
  - Sub Module
- Network

**Configuring Sub Module Information**

Module Add...	Module Type	Module Status	Module Version	Settings
1	Nametag Module	Online	V1.0.0 ...d190522	
2	Keypad Module	Online	V1.0.0 ...d191009	

Key number	Room No.
1	<input type="text" value="2"/>
2	<input type="text" value="3"/>
3	<input type="text" value="4"/>
4	<input type="text" value="5"/>
5	<input type="text" value="6"/>
6	<input type="text" value="7"/>

Konfiguration af lejlighedsnummeret på monitoren:

For at lejlighedernes ringeklokker tildeles de rigtige monitører, skal monitorernes lejlighedsnumre stemme overens med ringeklokkernes numre.

Den enkelte monitors lejlighedsnummer vises på monitorens hovedoversigt.

Du kan enten ændre nummeret direkte i konfigurationen i monitoren (konfiguration/lejlighedsnr.) eller få adgang til den enkelte monitor med ABUS CMS-softwaren og i menuen "Intercom/Room Number" ændre lejlighedsnummeret på "room.No.:". .

### Eksempel på dækslet til klokkeknappen på videodørmodulet

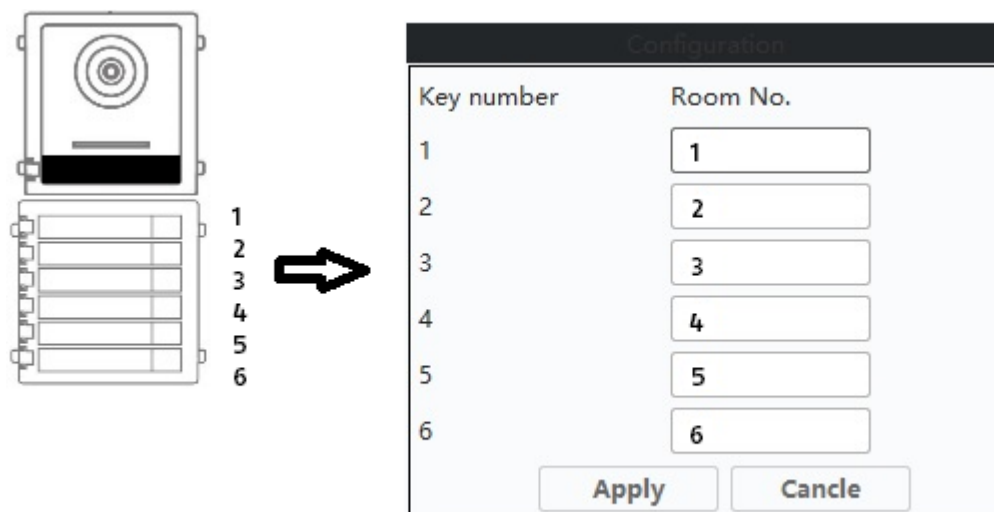

#### **9.4 Indstilling af lydstyrke på dør-videomodulet (TVHS20000, TVHS20010)**

Via ABUS CMS-softwaren kan mikrofonens følsomhed og lydstyrke på dør-videomodulet indstilles. Desuden kan du indstille eller helt deaktivere aktiveringstoner / opkalds-valgtoner / lydstyrken for optaget-signalet.

<b>Knap / visning</b>	<b>Beskrivelse</b>
Volume In	Regulerer mikrofonens følsomhed på dør-videomodulet. Jo højere værdien er, jo højere overføres talen til monitoren.
Volume Out	Regulerer det automatiske talte svar (f.eks.: Efterlad en besked, opkald mislykket osv. Desuden kan lydstyrken for bekræftelsestonerne / opkalds-valgtonerne og optaget-signalet indstilles via denne regulator. (På 0 er det helt lydløst)
Talk Volume	Her indstilles talens lydstyrke. Jo højere værdien er, jo højere overføres talen fra monitoren til dørstationen.

## Remote Configuration

The screenshot displays the 'Remote Configuration' interface. On the left is a navigation menu with categories: System (Device Information, General, Time, System Maintenance, User, RS485) and Intercom (ID Configuration, Time Parameters, Permission Password, Access and Elevator Control, IO Input/Output, Volume Input/Output, Dial, Motion Detection, Intercom Protocol). The 'Volume Input/Output' option is selected. The main area is titled 'Configuring the Volume Input or Output' and contains three sliders: 'Volume Input' (set to 7), 'Volume Output' (set to 7), and 'Talk Volume' (set to 7). A 'Save' button is located at the bottom right of the configuration area.

### 9.5 Tilslutning af en eksisterende dørklokke

Hvis du allerede har en ringeklokke / dørklokke, kan denne sluttes til på monitorens relæudgang 1 (COM / NO I). Relæet må belastes med maks. 2 A @ 30 VDC eller 0,5 A @ 125 AC.

Når der ringes på døren, omstilles relæet i ønsket interval og periode. Konfigurationen af "Relæ 1" findes i menuen til monitoren under "Relækonfiguration".

Relæet aktiveres, som det er tilfældet med den lokale ringetone på monitoren, ligeså længe som det er indstillet under "Ringetonens varighed" i menuen "Opkaldsindstillinger".

Hvis du kun vil høre, at det ringer på din eksterne dørklokke, kan du let aktivere eller deaktivere ringetonen på monitoren i "Opkaldsindstillinger" i menuen "Aktiver ringetone".

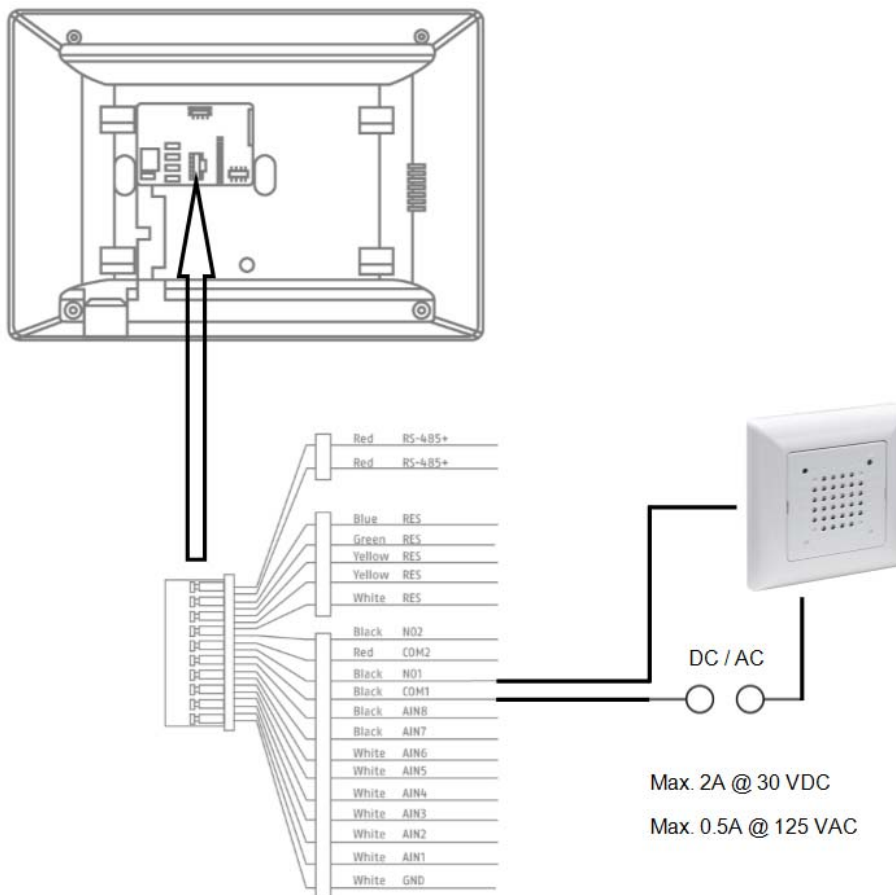

## 9.6 Tilslutning af eksisterende døråbner på dørstationens monitor

For at åbne en lejlighedsdør separat fra en hovedindgangsdør, giver monitoren mulighed for at aktivere endnu en dør via en relæudgang (relæ 2). Relæet må belastes med maks. 2 A 30 VDC / 0,5 A 125 AC.

For at bruge relæet på monitoren skal du aktivere "relæ 2" forinden i monitorens menu under "Relækonfiguration". Der vises nu endnu et "nøglesymbol" på monitoren med identifikatoren "3". Identifikator "1" og "2" er reserveret til dør-videomodulets relæer.

Relæ "3" på monitoren kan kun omstilles direkte via monitoren, ikke via ABUS LINK STATION appen.

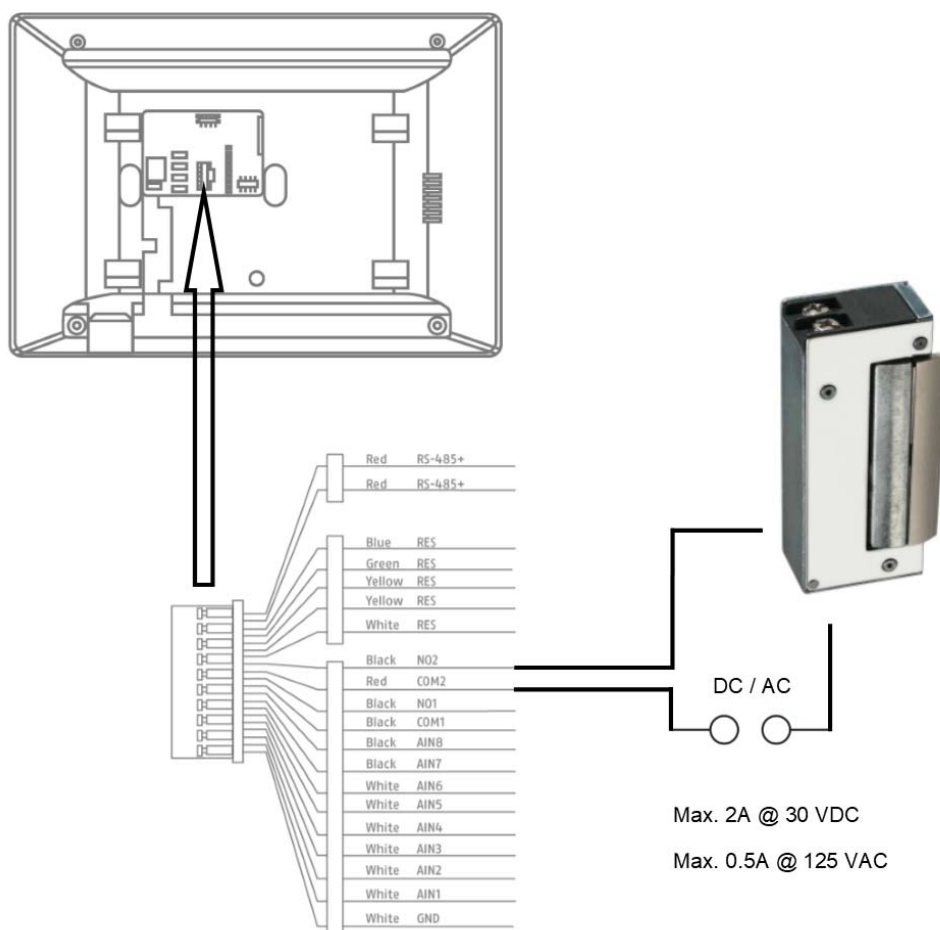

### 9.7 Tilslutning af etageringeklokker til hovedmonitoren

Etagetasterne (ringeklokker lige ved lejlighedsdøren til et flerfamilieshus) kan sluttet direkte til monitoren. Hvis monitoren er direkte sluttet til alarmindgang 1, kan den udsende et ringesignal og signalere over for kunden, at der er ringet på den øverste lejlighedsdør.

**Bemærk:** Etagetastens ringetone kan ikke ændres. Den adskiller sig fra lyden på dørvideomodul, så det kan ses, hvor der ringes på døren. Etagetasten fører ikke til nogen interaktion på monitoren. Der lyder kun en kort ringetone.

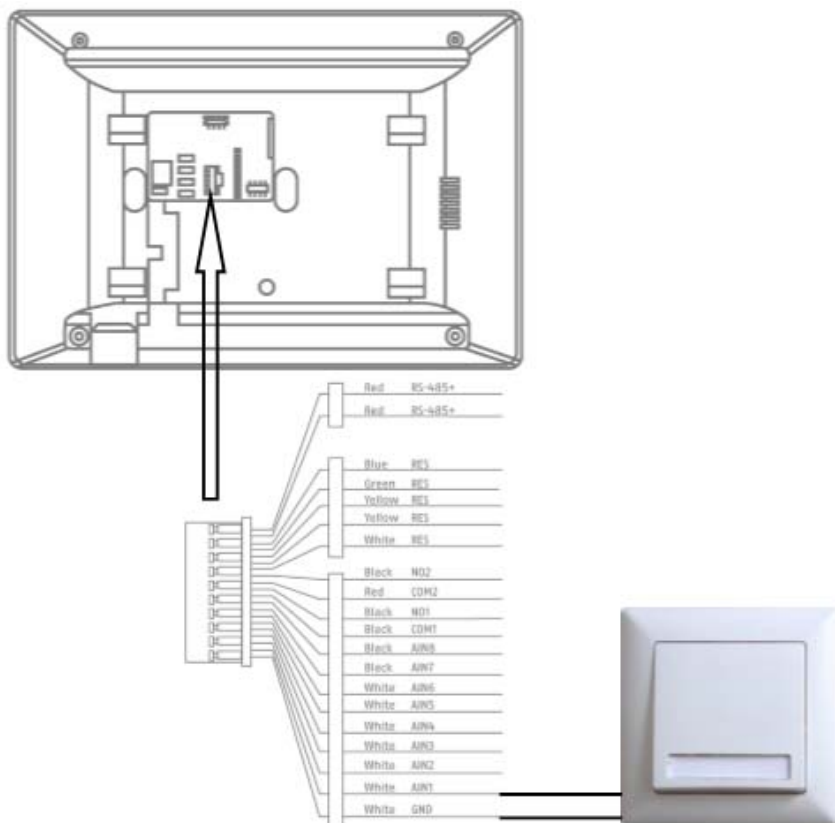

### 9.8 Tilslutning af elektrisk døråbner til videomodul (inkl. "havelåge")

På dør-videomodul kan 2 uafhængige relæer omstilles og dermed f.eks.: Åbne døre. For at konfigurere relæerne skal du åbne fjernkonfigurationen til dør-videomodul i ABUS CMS-softwaren og skifte til menuen "Intercom"/ "IO In Out".

På "IO out" kan de enkelte relæer til DOOR 1 og DOOR 2 konfigureres og ved behov også deaktiveres. Når relæet er deaktiveret, vises "nøgle"-symbolet til døråbning hverken i ABUS Link Station appen eller direkte på monitoren.

Bemærk: Der må kun stå ét af de to relæer på "securityModule" (sikkerhedsmodul TVHS10040).

Knap / visning	Beskrivelse
Disable	Relæet bruges ikke og skjules
electricLock	Dør-videomodulets interne relæ bruges
securityModule	Det eksterne sikkerhedsmodul TVHS10040 bruges. (Se menupunkt "Sikkerhedsmodul")

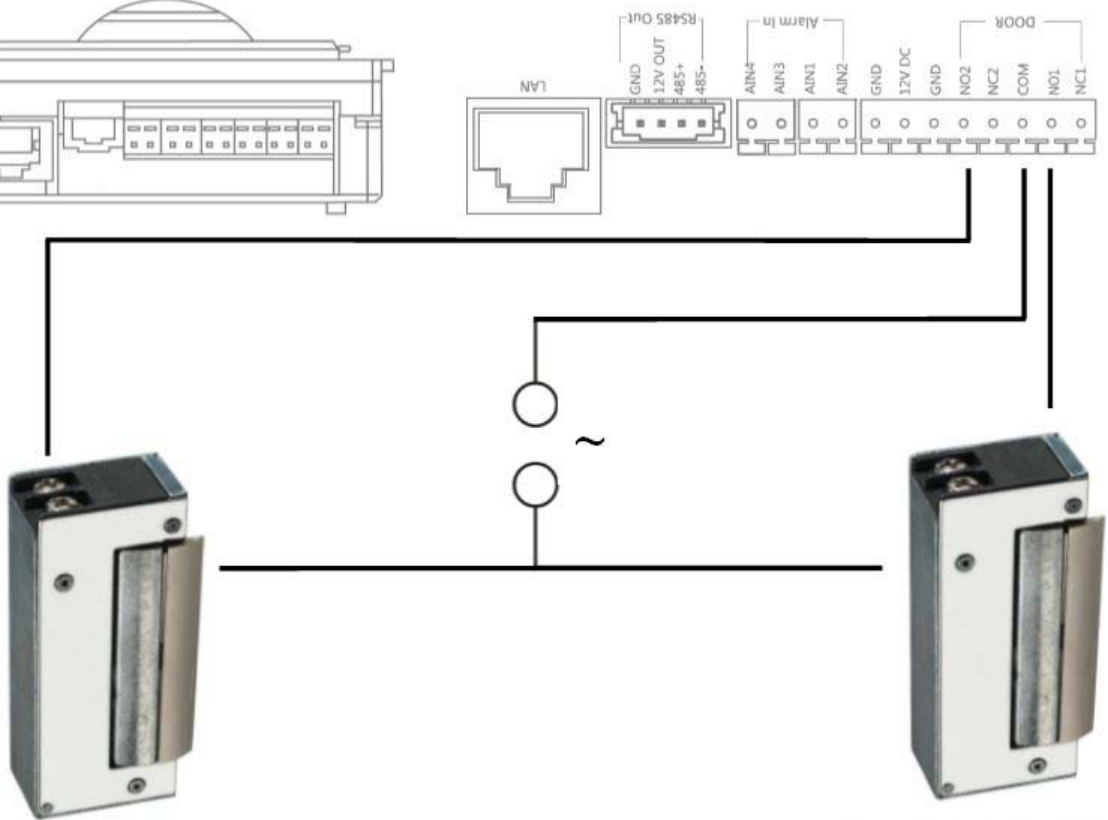
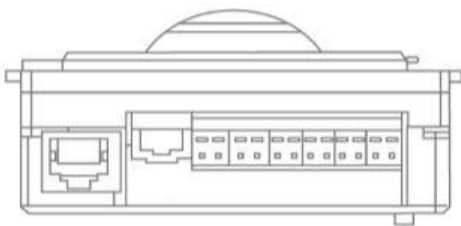
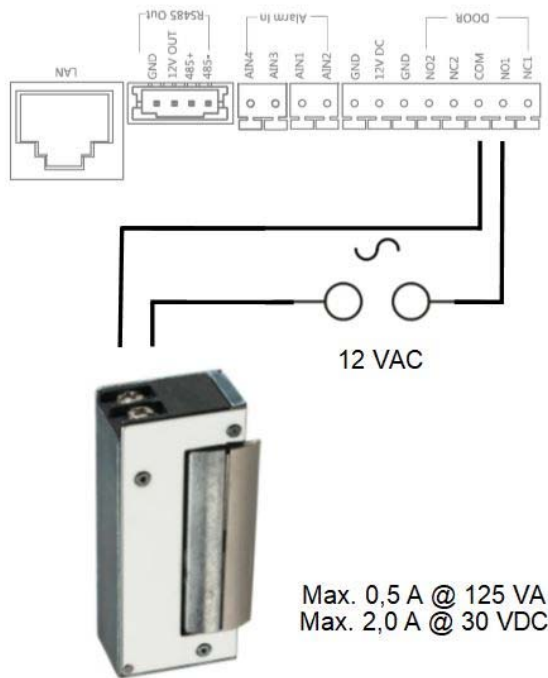
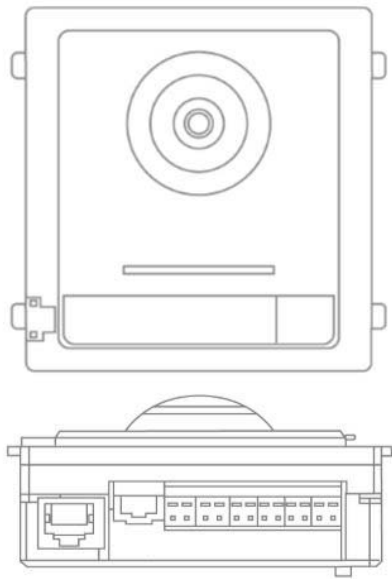

Max. 0,5 A @ 125 VA  
Max. 2,0 A @ 30 VDC

Max. 0,5 A @ 125 VA  
Max. 2,0 A @ 30 VDC

## 9.9 Tilpasning af egne ringetoner på dørstationens monitor

Du kan tilpasse dine egne ringetoner i \*wav-format via ABUS CMS-softwaren på din monitor. For at gøre det skal du åbne fjernkonfigurationen for den enkelte monitor og skifte til menuen "Ring import" på "Intercom". Vælg her et ledigt slot, og upload \*WAV-lydfilen. Efter upload står filen til rådighed direkte på monitoren under "Ringetoner".

**Vigtigt:** En ringetone valgt i monitoren kan ikke slettes via ABUS CMS-softwaren. Vælg først en anden ringetone på monitoren, og forsøg derefter igen at slette ringetonen i CMS.

Der skal nødvendigvis tages hensyn til følgende parametre for WAV-filen:

Format: wav;

Maksimal størrelse: ≥300 Kb;

Bitrate: 8 KHz;

Kanal: Mono

Bitrate: 128 Kbps

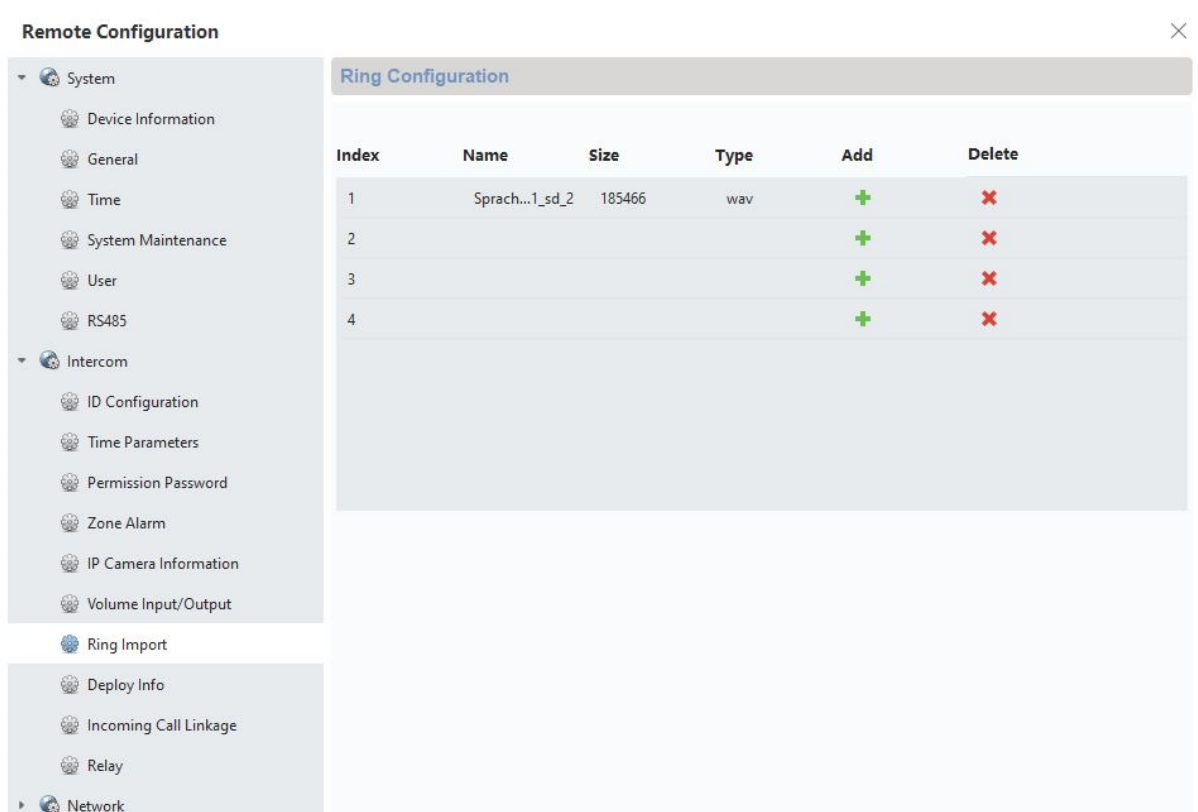

The screenshot shows the 'Remote Configuration' window with a sidebar menu on the left and a main content area on the right. The sidebar menu includes 'System' (Device Information, General, Time, System Maintenance, User, RS485) and 'Intercom' (ID Configuration, Time Parameters, Permission Password, Zone Alarm, IP Camera Information, Volume Input/Output, Ring Import, Deploy Info, Incoming Call Linkage, Relay). The 'Ring Import' option is selected. The main content area displays the 'Ring Configuration' table with the following data:

Index	Name	Size	Type	Add	Delete
1	Sprach...1_sd_2	185466	wav	+	×
2				+	×
3				+	×
4				+	×



## 9.10 ABUS CMS: Udfør firmwareopdatering af Moduvis-komponenterne

**Vigtigt:** Afbryd aldrig spændingsforsyningen eller netværkskablet under en opdatering

**Vigtigt:** Udfør kun opdateringen i stabile netværksomgivelser (LAN).

Det anbefales at indstille hver enhed på fabriksindstillinger efter en firmwareopdatering.

ABUS CMS-softwaren kræves for at installere en firmwareopdatering på en monitor eller på video-dørmodul. Forbind udstyret med netværket, og åbn fjernkonfigurationen for det enkelte udstyr.

Gå til "Maintenance" / "System Maintenance", og vælg den passende fil til udstyret.

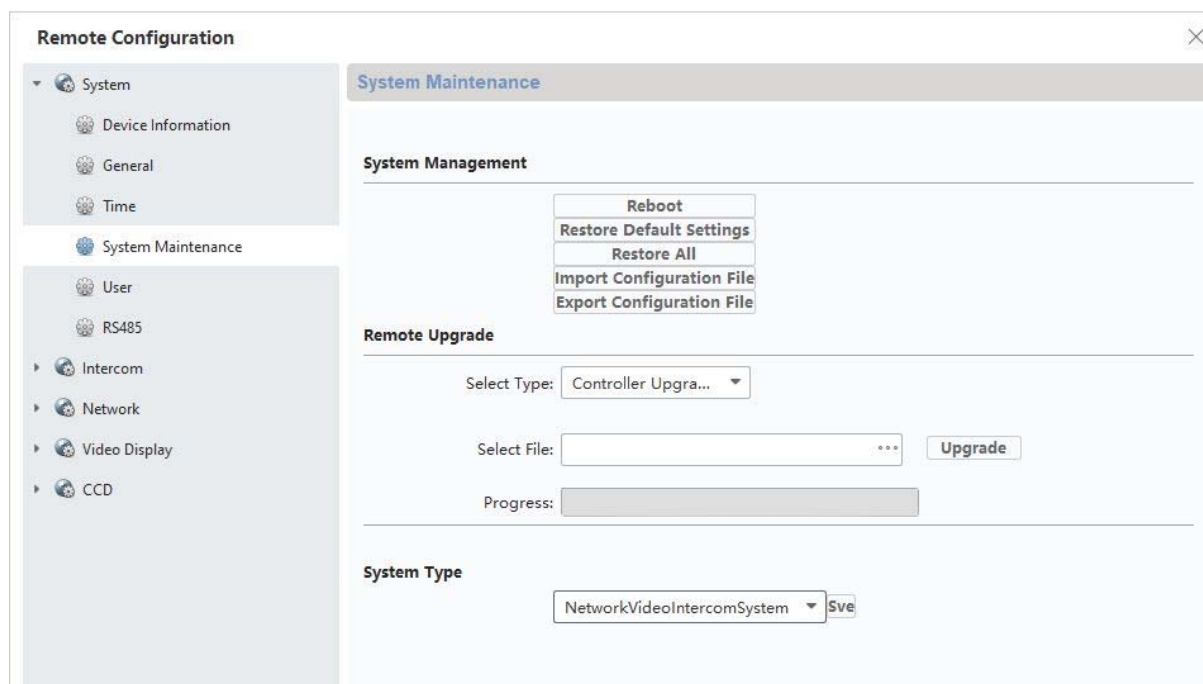

Ved opdatering af et dør-videomodul (TVHS20000, TVHS20010) skal der vælges "Controller-Upgrade".

Den aktuelle firmwareversion kan registreres med ABUS IP-installer eller i CMS-softwaren i den enkelte udstyrskonfiguration under "Device Information".

- System
  - Device Information
  - General
  - Time
  - System Maintenance
  - User
  - RS485
- Intercom
- Network
- Video Display
- CCD

Displaying the Device Information

**Basic Information**

Device Type:

Device Serial No.:

**Version Information**

Version: V2.2.3 build 201029

Hardware Version: 0x0

## 9.11 ABUS CMS: Udvidede indstillingsmuligheder

I det følgende findes en kort oversigt over indstillingsmulighederne via fjernkonfigurationen med ABUS CMS-softwaren.

Alle monitorer og dør-videomoduler vises som selvstændige netværksenheder i netværket. Her har det ingen betydning, om udstyret tilsluttes via 2-trådet eller PoE.

Fjernindstillinger på **TVHS20000(S)**, **TVHS20010(S)**, video-dørmodul:

### Remote Configuration

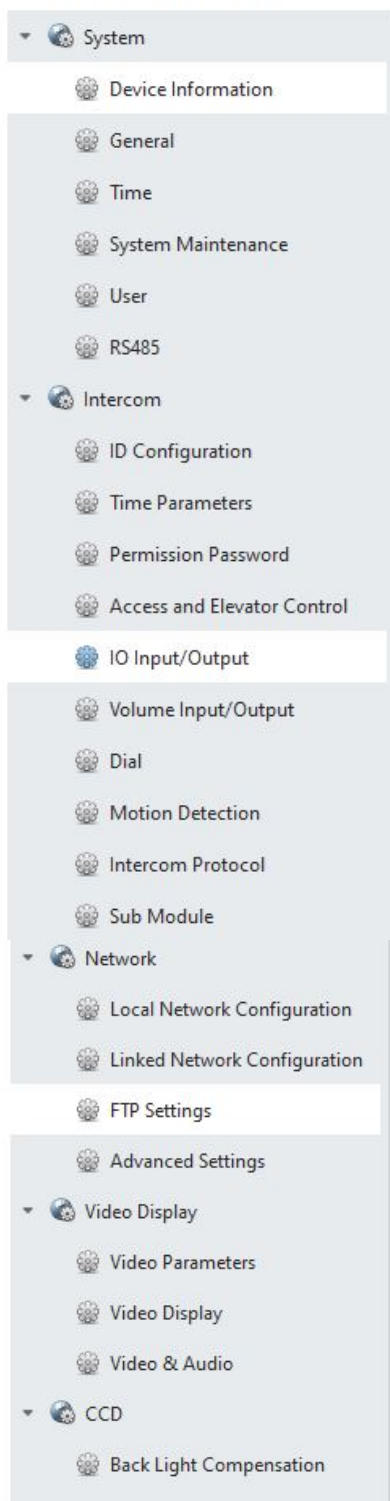

	Afsnit "System"
Device Information	Generelle informationer om firmware, serienummer
General	Udstyrs-ID navn og ID (ikke relevant for dørsamtalsystemet)
Time	Indstillinger for dato/klokkeslæt, sommertid og NTP-server
Maintenance	Vedligeholdelsesmenu til firmwareopdatering, indstilling af fabriksindstillinger og genstart af udstyret
User	Menu anvendes ikke
RS485	Menu anvendes ikke
Afsnit "Intercom"	
ID configuration	"Device-type" skal altid stå på "Outdoor unit". Undlad at ændre talværdierne for enhederne "Period, Building, Unit, Floor", da disse værdier ikke er nødvendige her. På "No.:" opsættes sideindgangene. 0 = Hoveddøre, "1" - "9" = Sideindgange. Se kapitlet "Opsætning sideindgange". (Se Instrukser til installation og ibrugtagning)
Time Parameters	<b>Max talk time:</b> Maks. samtalevarighed for et indgående opkald. (90-120 s) <b>Max Msg time:</b> Telefonsvarerens optagelsesvarighed (30-60 s)
Permission password	Her kan der indstilles 3 ekstra PIN-koder (6-cifrede) til brug i kombination med TVHS20030.
Access and elevator control	<b>Door. No.:</b> Valg mellem relæudgang 1 eller 2. <b>Open door time:</b> Bestemmer varigheden for, hvor længe relæet skal aktivere døråbneren. (1-255 s)  <b>"Door name" og "Card encrypt" bruges ikke.</b>
IO	Indstillinger for de digitale indgange (ikke

Input/Output	nød-døråbner) og relæet til døråbneren.
Volume Input Output	Indstillinger for video-dørmodulets lydparametre. (Se <u>Instrukser til installation og ibrugtagning</u> )
Dial	Bestemmer lejlighedstildelingen for ringeklokkerne på selve dør-videomodulet. Fra fabrikkens side står der "1" ved "room no.". På den måde ringes der til monitoren med lejlighedsnummer 1.
Motion detection	Indstilling af bevægelsesgenkendelsen i forbindelse med ABUS NVR. (Bevægelsesgenkendelsen må kun opsættes og konfigureres direkte via ABUS NVR)
Intercom Protocol	Anvendes ikke
Sub Module	Oversigt over tilsluttede udvidelsesmoduler, f.eks.: TVHS20020(S), TVHS20030(S), TVHS20040
	Afsnit "Network"
Local NetCfg	Video-dørmodulets IP-adresse. ( <b>IP-adresse, subnetmaske, standardgateway</b> )  <b>Port: 8000</b> kræves til integreringen i en ABUS NVR  <b>http-port</b> bruges ikke, da der ikke er noget webinterface
Linked network configuration	Menupunktet bruges ikke ved et hoved-video-dørmodul.  <b>Main Outdoor IP Address:</b> Bruges til tildeling af hoved-dørstationen til en sideindgang. (Se <u>Instrukser til installation og ibrugtagning</u> )
FTP Configuration	Anvendes ikke
Advanced settings	Konfiguration af DNS-serveradressen for dør-videomodulet
	Afsnit "Display"
Video parameters	Indstillinger af billedparametre (lysstyrke, kontrast, mætning)
Video Display	Indstillinger af OSD-visning (kameranavn, dato, klokkeslæt, tekstposition)
Video&Audio	Indstillinger af streamparametre på video-dørmodulets kamera. <b>Vigtigt:</b> Det anbefales ikke at ændre indstillinger.
Back Light compensation	Indstillingsmuligheder for BLC-funktionen for at kompensere for modlys.

## Fjernkonfiguration "Monitor TVHS20200, TVHS20210":

System
Device Information
General
Time
System Maintenance
User
RS485
Intercom
ID Configuration
Time Parameters
Permission Password
Zone Alarm
IP Camera Information
Volume Input/Output
Ring Import
Deploy Info
Incoming Call Linkage
Relay
Network
Local Network Configuration
Linked Network Configuration
Advanced Settings
ABUS Link Station

Device Information	Informationer som "firmware", "serienummer" osv.
General	Udstyrs-ID navn og ID (ikke relevant for dørsamtalsystemet)
Time	Indstillinger for dato/klokkeslæt, sommertid og NTP-server
Maintenance	Vedligeholdelsesmenu til firmwareopdatering, indstilling af fabriksindstillinger og genstart af udstyret
User	Anvendes ikke
RS485	Anvendes ikke
	Afsnit "Intercom"
ID configuration	Valg af lejlighedsnummer i driftsmåden "Indoor Station" (hovedmonitor) I modus "Station Extension" (udvidelsesmonitor) konfigureres udvidelsesmonitorens nummer.  Bemærk: Valg af driftsmåden "Hovedmonitor" eller "Udvidelsesmonitor" samt tildeling af numrene sker normalt via menuen for de enkelte monitorer. (F.eks.: Under opsætningen via installations-wizard
Time Parameters	Indstillinger af opkaldsvarighed, visningsvarighed for livebilleder, forsinkelse for omstilling af opkald, ringetonens varighed. Bemærk: Disse indstillinger kan også ændres direkte i monitorens menu.
Permission password	Bruges ikke i monitorens fjernkonfiguration.
Zone Alarm	Anvendes ikke
IP camera information	Tilføjelse af ABUS-netværkskameraer. (Se kompatibilitetsliste) Der kan tilføjes op til 16 ABUS netværkskameraer, som kan ses live. (Ingen mulighed for afspilning eller konfiguration af kameraet direkte via dørstationen)
Volume Input Output	(Se <a href="#">Instrukser til installation og ibrugtagning</a> )
Ring Import	Administration af egne ringetoner (se <a href="#">Instrukser til installation og ibrugtagning</a> )
Deploy Info	Anvendes ikke
Incoming Call Linkage	Anvendes ikke
Relay	Anvendes ikke
	Afsnit "Network"

Local NetCfg	<p>Monitorens IP-adresse. (<b>IP-adresse, subnetmaske, standardgateway</b>)</p> <p><b>Port: 8000</b> bruges ikke her</p> <p><b>http-port</b> bruges ikke, da der ikke er noget webinterface</p>
Linked network configuration	<p>Tildeling af hovedmonitoren til hoved-dør-videomodulet. Hvis der er en hovedmonitor, indtastes her hoved-dørmodulets IP-adresse. Indtastningen "MainOutdoorUnit" må ikke ændres.</p> <p><b>Bemærk:</b> Tildelingen af dør-videomodul til monitoren sker normalt allerede ved opsætningen lokalt på selve monitoren.</p>
Advanced settings	<p>Konfiguration af DNS-serveren fra monitoren.</p>
ABUS Link Station	<p>Konfiguration af adgangen via ABUS Link Station appen. <b>Se Indstillinger ABUS Link Station tjeneste.</b> Forbindelsen med ABUS Link Station appen kan let foretages via overfladen på selve monitoren.</p>

## 9.12 Funktioner MODUVIS og ABUS Link Station appen

MODUVIS dørsamtaleanlægget kan integreres i ABUS Link Station appen. Der er følgende muligheder:

Ændring af verifikationskode:	Verifikationskoden bør ændres som det første i menupunktet "ABUS Link Station tjeneste". Klik på den aktuelt viste kode.
Tilføj:	Scan QR-koden, og tilføj udstyret til appen. Det er stadig nødvendigt at indtaste verifikationskoden
Del udstyr:	Dørsamtaleanlægget kan deles med andre brugere. På den måde har flere personer eller apps adgang til anlægget.
Push-muligheder:	Når der ringes på dørsamtaleanlægget, kan ABUS Link Station appen åbnes umiddelbart eller forsinket. Opkaldet kan besvares via appen, og der er mulighed for samtale med dørstationens video. Ved begrænset modtagelseskvalitet eller mobilt bredbånd kan videoen deaktiveres, og der kan kun tales.
Åbn dør:	Relæ 1 eller relæ 2 kan omstilles via appen. På den måde kan f.eks. de elektriske døråbnere aktiveres.
Hændelseslog:	Appen har en besked-side med registreringer af de seneste ringeaktiviteter med et hændelsesbillede.

## 9.13 Kompatibilitet med ABUS produkter

Dette afsnit beskriver et muligt samspil med andre ABUS produkter.

ABUS-produkt	Kompatibilitet
Secvest	Nej
WAppLoxx	Relætilslutning
WAppLoxx Pro	Relætilslutning
ABUS IP-kameraer	Se kompatibilitetsliste <a href="http://www.abus.com">www.abus.com</a> , <a href="http://www.abus-sc.de">www.abus-sc.de</a>
ABUS NVR	Integrering af dørstationens video, se afsnit 9.14
ABUS Link Station app	Åbning af dørstationens livebillede Push-meddelelse, når der ringes på døren

## 9.14 Integrering af video-dørmodulet i ABUS NVR

Videobilledet fra videodørmodulet kan også integreres i en ABUS NVR. Der tages på videoen ved hjælp af RTSP-protokollen, som kun muliggør permanent visning eller permanent optagelse (ingen bevægelsesdetektering eller andre typer hændelsesoptagelser).



Bemærk de databeskyttelsesbestemmelser, der gælder på installationsstedet!

Følgende trin er nødvendige for integrationen:

1. Oprettelse af en brugerdefineret protokol i ABUS NVRs kamerastyring.
2. Følgende streamdetaljer skal bruges:  
Protokol: RTSP  
Overførselsprotokol: Automatisk  
Havn: 554 (standardport)  
Stream sti: Streaming / Channels / 101 (Main Stream)  
Streaming / kanaler / 102 (understrøm)
3. Når du tilføjer en ny kanal til NVR, vælges denne brugerdefinerede protokol til videodørmodulet.  
Brugernavn ("admin") og adgangskode er normalt de samme som dørstationens monitor.  
Hvis adgangskoden blev ændret via CMS-softwaren, skal denne ændrede adgangskode bruges.

### 9.15 "Nød-døråbner"-tast på dør-videomodulet

På dør-videomodulet kan der via alarmindgang 3 (AIN 3 = Relæ 1) og alarm indgang 4 (AIN 4 = Relæ 2) placeres en tast/kontakt, som omstiller dørrelæet ved aktivering.

For at aktivere alarmindgangen 3 (AI3 og AI4) skal du åbne fjernkonfigurationen for det enkelte dør-videomodul med ABUS CMS-softwaren og indstille AI3 på "openDoorBtn"

Dør-videomodulets AIN3 åbner nu døren på relæ 1  
Dør-videomodulets AIN4 åbner nu døren på relæ 2

Af sikkerhedsmæssige årsager er denne funktion deaktiveret ved levering.

The screenshot shows a configuration window for an IO module. It has a title bar 'IO In Out'. Below it, there are two main sections: 'IO In' and 'IO Out'.  
In the 'IO In' section, there are two dropdown menus: 'IO In No.' is set to 'AI3' and 'Use In' is set to 'openDoorBtn'.  
In the 'IO Out' section, there are two dropdown menus: 'IO Out No.' is set to 'DOOR1' and 'Use out' is set to 'electricLock'.  
At the bottom of the configuration area, there is a 'Save' button.



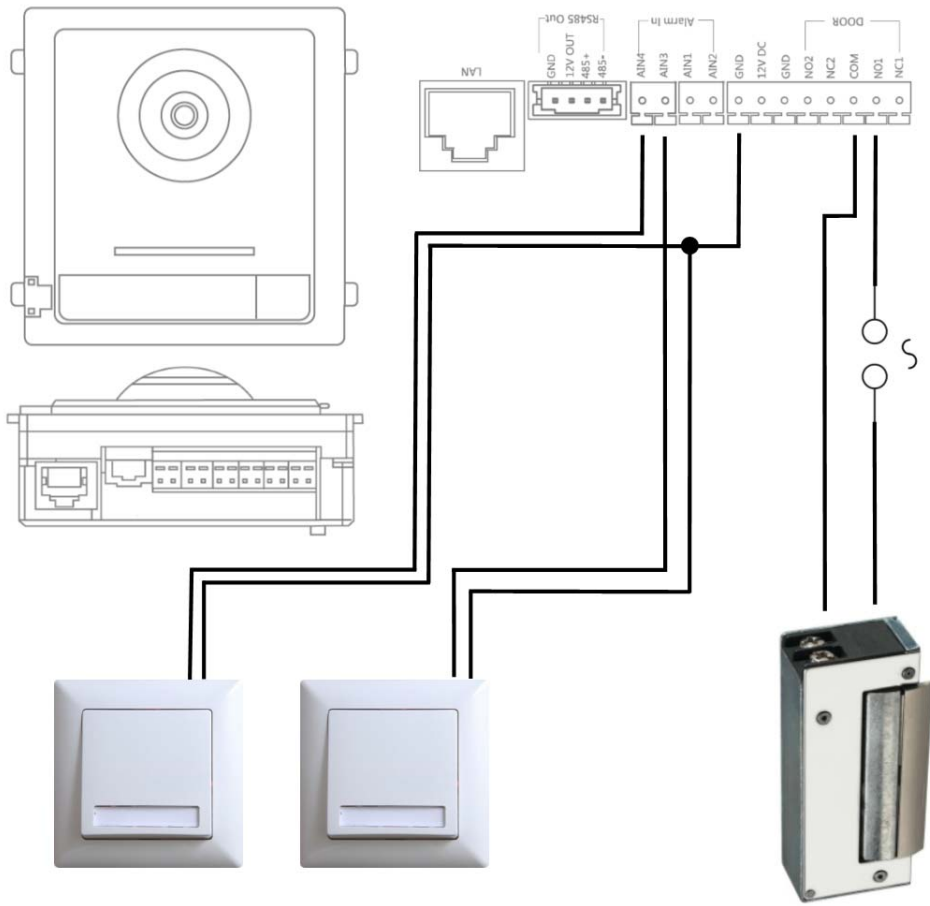

Max. 2A @ 30 VDC  
 Max. 0.5A @ 125 VAC

## 9.16 Relætilslutning

Dør-videomodules (TVHS20xxx) relæ, sikkerhedsmodul TVHS10040 samt monitorerne TVHS20xxx må belastes med maks. 2 A 30 VDC / 0,5 A 125 AC. En overbelastning medfører en defekt på udstyret.

Det er vigtigt at registrere strømforbruget for din eksisterende døråbner / motorlås. Hvis den tilladte strømstyrke overskrides, anbefaler vi, at der tilkobles et eksternt relæ.

Dør-videomodulet har en separat 12 V DC-spændingsudgang. Med denne kan et eksternt hjælperelæ tilsluttes direkte uden yderligere spændingsforsyning.

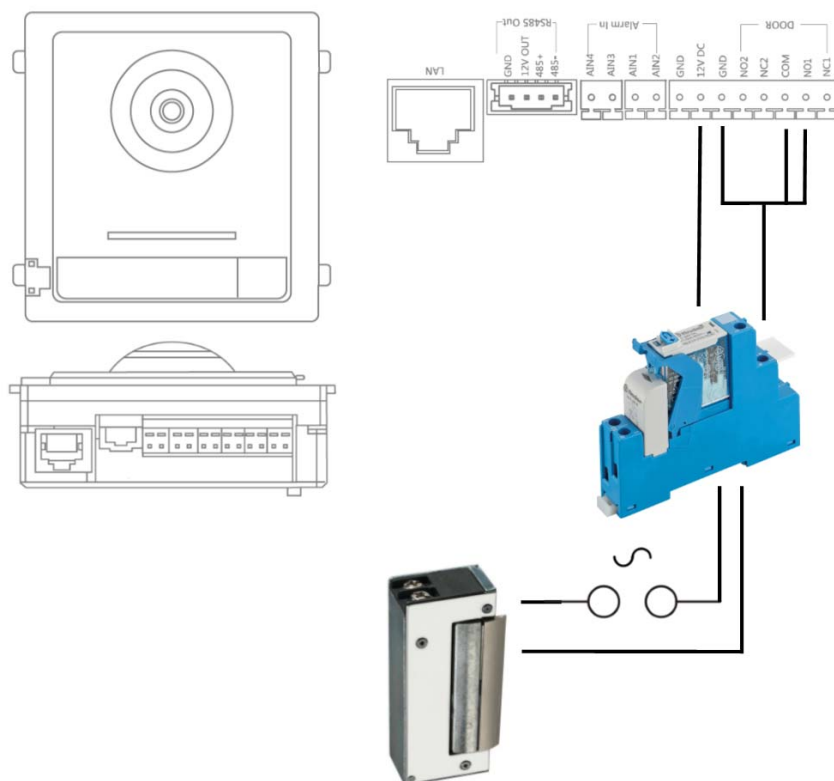

Topskinne relæ:

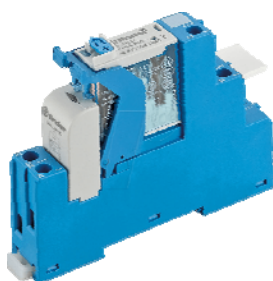

Eksempel: Færdig opbygget 12 V-relæprintkort



### 9.17 Vejledning til måling af den eksisterende døråbner

Hvis du vil aktivere en allerede eksisterende døråbner og ikke har informationer om strømforbruget, skal det kontrolleres inden tilslutning af dør-videomodulets relæ, at det maksimale strømforbrug ikke overbelaster relæet.

Derfor skal døråbnerens strømforbrug måles. Adskil et strømførende kabel, og placer strømmåleren ind imellem (i række).

### 9.18 Anvendelseseksempel "videomodul foran hver lejlighedsdør"

Ofte er der et ønske om også at placere et videomodul foran hver lejlighedsdør i en lejlighedsbygning for at få en 180 ° -video af området foran lejlighedsdøren (kighuller er normalt meget skarpe vinklede inden for vision).

Dette kan programmeres til op til 16 lejlighedsdøre ved hjælp af funktionen "Sideindgang" i videomodulet.

#### LAN-variant

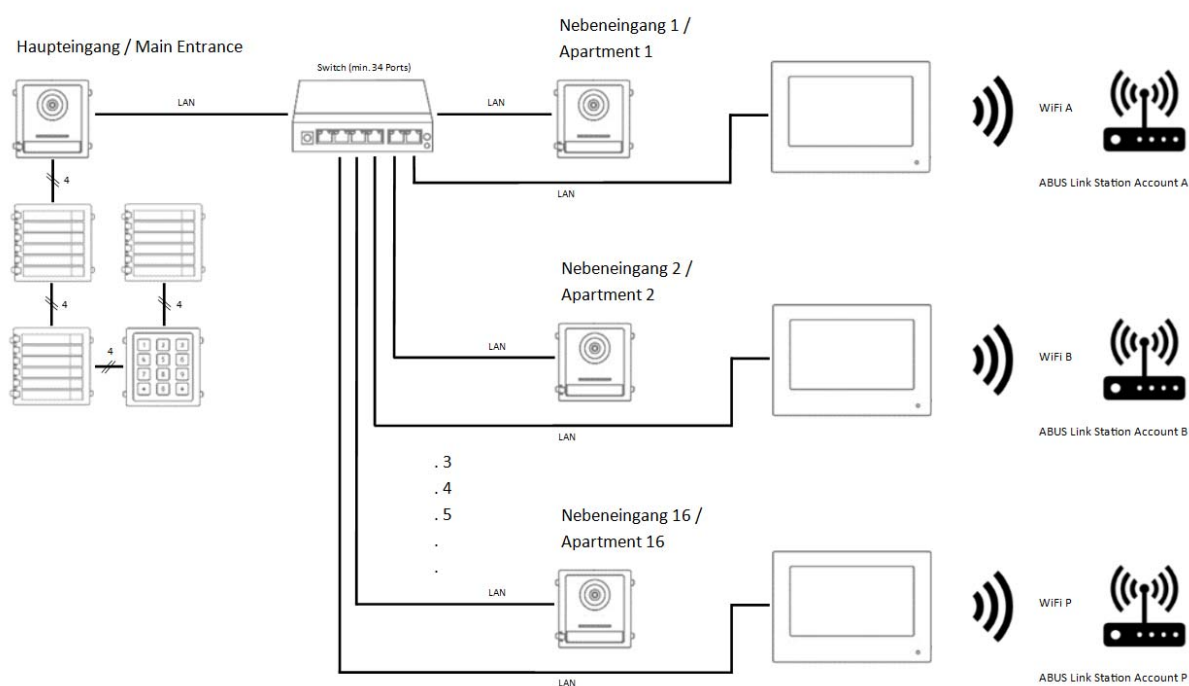

#### 2-leder variant

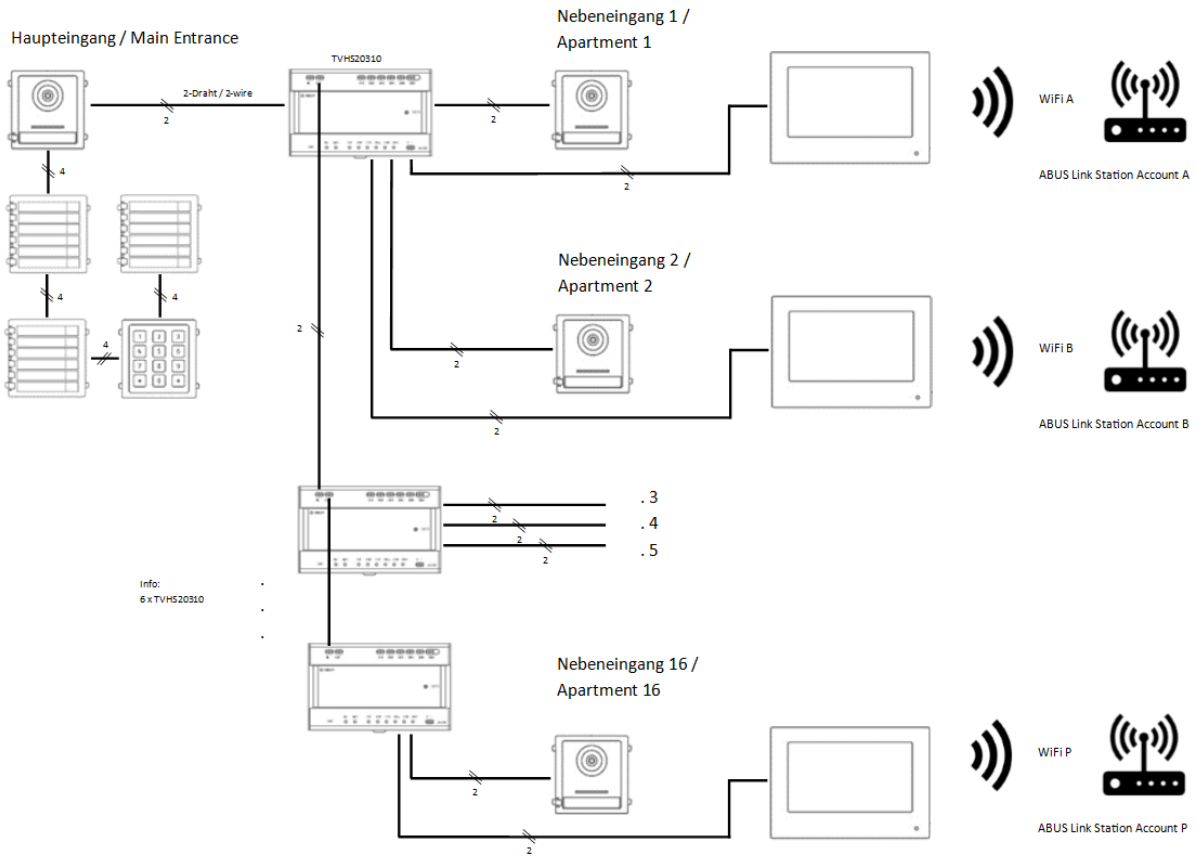

**Remote Configuration**

- System
  - Device Information
  - General
  - Time
  - System Maintenance
  - User
  - RS485
- Intercom
  - ID Configuration
  - Time Parameters
  - Permission Password
  - Access and Elevator Control
  - IO Input/Output
  - Volume Input/Output
  - Dial
  - Motion Detection
  - Intercom Protocol
  - Sub Module
- Network
- Video Display
- CCD

**Configuring the Room Numbers**

**Device No. Configuration**

Device Type: Door Station

Project No.: 1

Community No.: 1

Building No.: 1

Floor No.: 1

No.: 1

Save

**Reboot**

Master Outdoor Device to Slave Device will cause the device to reboot, Are you sure?

OK Cancel

**Remote Configuration** ✕

- Time
- System Maintenance
- User
- RS485
- ▼ Intercom
  - ID Configuration
  - Time Parameters
  - Access and Elevator Control
  - IO Input/Output
  - Volume Input/Output

**Configuring the Network and Sip Parameters**

**Linked Network Configuration**

Device Type:

Master Station IP Address:

(Main) Door Station IP Address:

SIP Server IP Address:

Security Control Panel IP Address:

Security Control Panel Port No.:

**Remote Configuration** ✕

- ▼ System
  - Device Information
  - General
  - Time
  - System Maintenance
  - User
  - RS485
- ▼ Intercom
  - ID Configuration
  - Time Parameters
  - Permission Password
  - Access and Elevator Control
  - IO Input/Output
  - Volume Input/Output
- Dial
- Motion Detection
- Intercom Protocol
- Sub Module
- ▶ Network
- ▶ Video Display
- ▶ CCD

**Configuring the Key Call Room Parameters**

**Dial**

Number:

Room No.:

Quick Press for Calling Center

### 9.19 Applikationseksempel "Individuel WiFi-adgang"

I en lejlighedskompleks er der ofte ingen central internetforbindelse for alle boligenheder. Hver bolig har muligvis sin egen internetforbindelse.

En forbindelse til den kundespecifikke internetforbindelse kan oprettes via hovedskærmens WiFi-funktion.

Det betyder, at der også er adgang til ABUS Link Station-funktionen med push-besked, når dørklokken ringer individuelt for hver boligenhed.

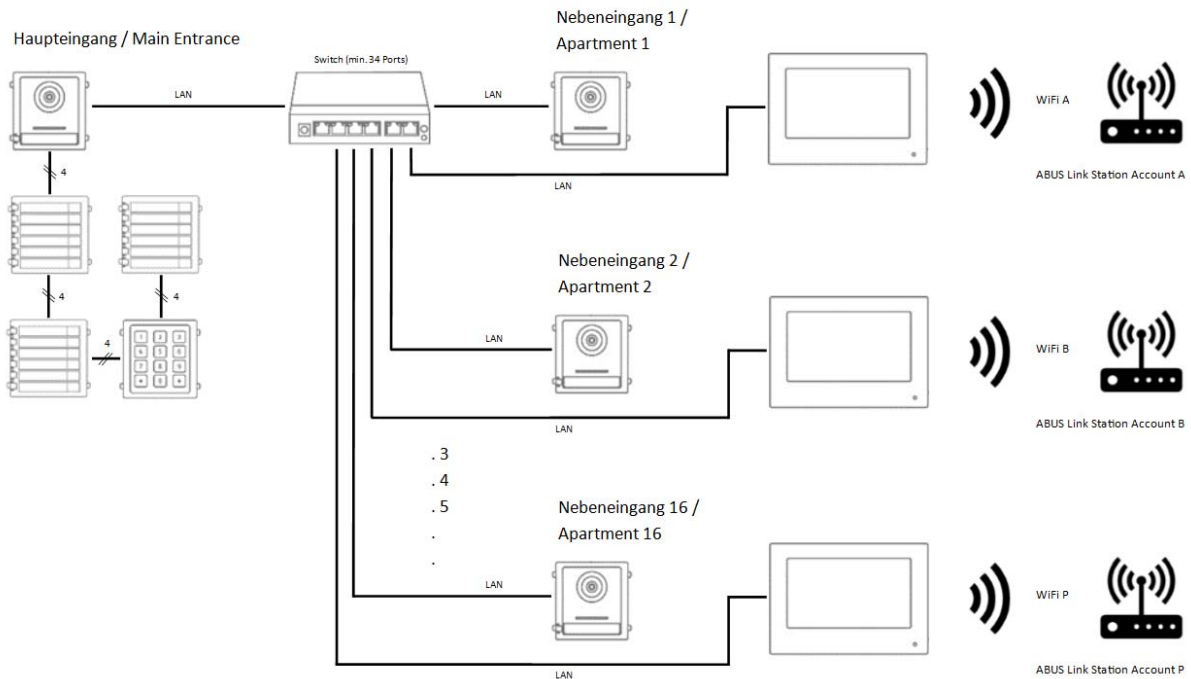

Wlan-Einstellungen		⚙️
📶	<input type="checkbox"/>	⚙️
MAX_MUSTERWLAN	📶	📶
		🔧

## 10. Ledningsføring (2-leder)

Et dokument med yderligere information om tilslutning af 2-leder dør-intercom-systemet findes på [www.abus.com](http://www.abus.com), fx på TVHS20010-produktet:

[https://www.abus.com/var/ImagesPIM/d110001/medias/docus/25/Moduvis\\_Verkabelung\\_Wiring\\_2wire\\_V1.1.pdf](https://www.abus.com/var/ImagesPIM/d110001/medias/docus/25/Moduvis_Verkabelung_Wiring_2wire_V1.1.pdf)