

Installation instructions and Operating instructions

wAppLoxx Pro Control Plus (WLX-PRO-CTRL-PLUS)

These operating instructions apply to the following items:

Item no	Product description
ACCO16000	wAppLoxx Pro Control Plus
ACCO16500	wAppLoxx Pro Control Plus incl. wireless module for wAppLoxx cylinder



Contents

1. General	4
1.1. Safety information	4
1.2. wAppLoxx Pro Control Plus technical data	7
1.3. Structure and scope of functions of a wAppLoxx Pro Plus slave control	9
1.4. wAppLoxx Pro Repeater technical data	10
1.5. Operation of wAppLoxx components	11
1.6. Special features compared to the wAppLoxx Pro Control	12
2. Installing the wAppLoxx Pro Control Plus	14
3. wAppLoxx Pro Control Plus connections	15
4. LED signalling	17
5. Starting up the wAppLoxx Pro Control Plus using the Manager	18
6. System settings	23
6.1. Date and time	23
6.2. System access	25
6.3. Notifications	28
6.4. Network settings	29
6.5. Language	29
6.6. Upgrade and restore	30
6.7. Role management	32
6.8. External access to the wAppLoxx Pro Plus system	35
7. Configuration of the components	37
7.1. wAppLoxx Pro Plus Slave Control	37
7.2. wAppLoxx Pro Repeater	40
7.3. wAppLoxx Pro Cylinder	44
7.4. wAppLoxx Pro Wall Reader or Bridge Box	50
8. Setting up a master key system	52
8.1. Creating door groups	52
8.2. Users and tags	54
8.3. User Groups	60
8.4. Schedules	61
8.5. Holiday schedules	62
8.6. Key lock plan	63
9. Cameras	64

10. Events	65
10.1. Intrusion	65
10.2. Example – Secvest	70
10.3. Example FaceXess	81
10.4. General events	83
11. User Login	86
11.1. Remote functions	87
11.2. Protocol/Event Log	88
12. wAppLoxx Pro Plus App	90
12.1. Configuration of the wAppLoxx Pro Plus App	90
12.2. Functions of the wAppLoxx Pro Plus App	94
13. Terms of use for wAppLoxx Pro Plus	99
14. Open Source Licence information	102
15. Disposal instructions	103

1. General

This product complies with current domestic and European regulations. Conformity has been certified, and all related certifications are available from the manufacturer on request. To ensure the condition of this product is maintained and safe operation is guaranteed, these operating instructions must be observed. No part of the product may be changed or modified in any way. Finger contact with the electronics should also be avoided. ABUS Security Center GmbH & Co. KG shall not be held liable for loss or damage caused – or alleged to have been caused – either directly or indirectly by this manual. We reserve the right to make changes to the content of this manual without prior notice.

1.1. Safety information

Explanation of symbols



The triangular high voltage symbol is used to warn of the risk of injury or health hazards (e.g. caused by electric shock).



The triangular warning symbol indicates important notes in this user guide which must be observed.



This symbol indicates special tips and notes on the operation of the unit.

Safety information



Please observe the following instructions for the wAppLoxx Pro Control Plus to avoid fire and injury:

- And mount the device securely in a dry area of the building.
- Ensure there is sufficient ventilation for the device.
- The device is designed for indoor use only.
- Do not exceed maximum air humidity of 80% (non-condensing).
- Ensure that no metal objects can be inserted into the device from the outside.
- Disconnect the device from the power supply before any installation work is carried out.
- The device is supplied power via a separate power supply unit (not included). Please use only the recommended power supply unit (item no.: 505366), otherwise the CE certification is not applicable.
- The power supply unit is connected to the building's 230 VAC grid via a separately secured line.

- Connection to the building's grid is subject to the country's specific regulations.



Information on the wireless range:

- The wireless range between the wAppLoxx Pro Cylinder and the wAppLoxx Pro Control Plus is largely dependent on the individual local conditions, particularly the building structure and electromagnetic interferences (from machines, high-voltage lines, etc.). Extreme interference with the wireless traffic can lead to a four-minute safety shutdown.
- It is essential to check whether there is an adequate wireless connection prior to installation and commissioning.

Battery instructions

The wAppLoxx Pro Control Plus is powered for time buffering via a 3 V CR2 lithium battery that is included in the scope of delivery.



In order to ensure a long lifespan and to prevent fire and injury, comply with the following instructions:

- When inserting the battery, ensure the polarity is correct.
- Do not insert the battery until the wAppLoxx Pro Control Plus is ready for use, otherwise the battery will discharge more quickly.
- Batteries must not be exposed to direct sunlight or other heat sources or stored in places exposed to very high temperatures.
- Keep batteries away from children.
- Batteries are not rechargeable.
- Batteries must not be dismantled, pierced or otherwise damaged. They must not be burned, come into contact with water or be short-circuited.
- If batteries are replaced, take note of temperature details specified by the manufacturer.



If after the initial commissioning of the wAppLoxx Pro Control Plus, the signal lights do not light up properly, please restart the wAppLoxx Pro Control Plus.



To ensure a long lifespan and safe operation, we recommend using the following high-quality batteries:

wAppLoxx Pro Cylinder

Varta CR2 Lithium CR17355 Photo Battery

wAppLoxx Pro Control Plus

Duracell Lithium Coin CR1220 35 mAh, 3 V

(To ensure reliable buffering of the system time, we recommend changing the CR1220 installed in the wAppLoxx Pro Control Plus at regular, two-year intervals.)



After replacing the batteries, you must always check that the device is functioning correctly.



Batteries must not be disposed of along with household waste in accordance with the battery directive; they must be taken to designated collection points. Only take lithium batteries and battery packs that have been drained to disposal points and take precautions against short circuits!

1.2. wAppLoxx Pro Control Plus technical data

<u>Scope of delivery:</u>	wAppLoxx Pro Control Plus, Quick Guide, System Card, Reset Card, 2 antennas, Duracell button battery
<u>Voltage supply:</u>	12 V DC, 1.5 A, via external power source (not included)
<u>Power consumption:</u>	max. 500 mA at 12 V DC (when using the power supply unit listed above)
<u>Backup power supply:</u>	optionally available with accessories (ACAC00073), backup power supply for at least 14 hours
<u>Humidity:</u>	Max. 80% relative humidity, non-condensing
<u>Operating Temperature:</u>	0 °C to 40 °C
<u>Radio frequency:</u>	868.3 MHz
<u>Wireless range:</u>	Approx. 30 m indoors (100 m free field nominal) With repeater/slave control approx. 60 m (max. 6 repeaters per control and max. 5 controls per system)
<u>Encryption:</u>	AES 128-Bit
<u>Exterior dimensions:</u>	248 × 277 × 53 mm (H × W × D)
<u>Material:</u>	White plastic housing
<u>Tags:</u>	Max. 1000
<u>Door components:</u>	32 door components with one wAppLoxx Pro Control Plus 32 additional door components possible per slave control (max. 4 slave controls) → Max. 160 door components possible with 5 controls Max. 160 door groups
<u>User groups:</u>	Max. 100
<u>Configuration:</u>	Web interface (web browser, platform-independent)
<u>Functions:</u>	Optional permissions for access and/or “arming”/“disarming” of up to 2 alarm systems Special key for a guard user Fallback tag Remote access authorisation Remote “arming”/“disarming” Event management and email notification Logging and time function wAppLoxx compatible (only applies to item no. ACCO16500)



The wAppLoxx Pro Control Plus has been optimised for use in conjunction with alarm systems. Some functions are therefore only available if an interface to an alarm system has been set up for the wAppLoxx Pro Control Plus (Chapter 10.1).

1.3. Structure and scope of functions of a wAppLoxx Pro Plus slave control

What is a wAppLoxx Pro Plus Slave Control?

The wAppLoxx Pro Plus slave control does not fundamentally differ from the master control. The role of the control is first defined by the installation and configuration in the system. After configuration, the power LED of a slave control lights up yellow continuously and that of a master control lights up green continuously.

What functions does a wAppLoxx Pro Plus slave control offer?

The cascading function allows you to connect up to five wAppLoxx Pro Control Plus in master-slave mode in a local network.

The master-slave function is used to increase the range of the wireless coverage. wAppLoxx door products are thereby directly programmed at the master control into the master or slave control or into an associated repeater.

Account management is only carried out at the system master control. All data such as user, locking plan, etc. are transferred from the master control to the slave controls.

What are the advantages of the wAppLoxx Pro Plus slave control compared to a repeater?

In the event of a master control failure, all slave controls, including the repeaters programmed into them, can continue to be used. It thus creates an additional safeguard for the system.

It is often not possible to integrate all door components into a wAppLoxx Pro system with a wAppLoxx Pro Control and repeaters. The reasons for this can be too much distance between the installation locations (max. 60 m) or radio-inhibiting materials.

By using a wAppLoxx Pro Plus slave control, remote parts of the building that are on the same local network can be connected. Spatially separated systems are created that can be managed by the administrator as an overall system.

Each additional slave control increases the maximum number of door components by 32, so that a total of up to 160 door components can be connected in the system (32 in the master control + 32 per additional slave control).

1.4. wAppLoxx Pro Repeater technical data

Scope of delivery: wAppLoxx Pro Repeater, quick guide, 2 antennas, power supply unit

Voltage

supply: 12 V DC / 3 A, via external power source

Power consumption: max. 65 mA or 175 mA (with battery) at 12 V DC
(when using the power supply unit listed above)

Conditions of use: Max. 80% relative humidity, non-condensing

Operating

Temperature: 0 °C to 40 °C

Radio frequency: 868.3 MHz

Wireless range: Approx. 30 metres indoors (100 m free field nominal)

Encryption: AES 128-Bit

Exterior dimensions: 164 × 164 × 37 mm (H × W × D)

Material: White plastic housing

Functions: Wireless extension of the wAppLoxx Pro system
Up to 32 door components (wAppLoxx Pro Cylinder and wall reader)
per repeater
Managing door components via wAppLoxx Pro Control Plus
Backup power supply via rechargeable battery (optional, accessory:
ACAC00068) for at least 20 hours

1.5. Operation of wAppLoxx components

The wAppLoxx Pro Control Plus is offered in two variants. In the variant with additional wireless module (ACCO16500), old cylinder generations can also be integrated. The compatibility of locking media depends on the cylinder generations used and the security mode desired.

wAppLoxx Pro Control Plus (ACCO16000)

Cylinders

Only wAppLoxx Pro cylinders can be programmed into the control.

Locking media



The security mode is active when delivered.

If the security mode is deactivated, all locking media and the Reset Card will be deleted the next time it is activated.

In **open mode**, ABUS-SC Mifare Desfire EV1 and Mifare Classic can be used as locking media. In **security mode**, only newer ABUS-SC Mifare Desfire EV1 transponders with white marking can be used as locking media.

wAppLoxx Pro Control Plus (ACCO16500)

Cylinders

The wAppLoxx, wAppLoxx AE and wAppLoxx Pro cylinders can be programmed in.

Locking media



The security mode is active when delivered.

If you also use wAppLoxx cylinders, all locking media and the Reset Card will be deleted each time the security mode is activated or deactivated.

In **open mode**, only Mifare Classic can be used in combination. If only wAppLoxx Pro cylinders are installed, ABUS-SC Mifare Desfire EV1 and Mifare Classic can be used. In **security mode**, only newer ABUS-SC Mifare Desfire EV1 transponders with white marking can be used in combination.

1.6. Special features compared to the wAppLoxx Pro Control

The following chapter illustrates the differences compared to the wAppLoxx Pro Control. Detailed descriptions can be found in the referenced chapters.

Inserting the button battery (see chapter 5)

A Duracell button battery is included in the delivery. This must be inserted into the battery holder before the control is started up.

First connection setup (see chapter 5)

With the wAppLoxx Pro Control, the first connection could only be established in the first 5 minutes. For other devices, a security key had to be passed on.

This condition does not apply to the new wAppLoxx Pro Control Plus. It can be registered at any time and with multiple devices.

In addition, the wAppLoxx Pro Plus Manager is used for start-up instead of the Finder. The Manager is available for download at the following link:

<https://mobil.abus.com/product/ACCO16000>

Initial registration (see chapter 5)

At initial registration, the username of the wAppLoxx Pro Control Plus is "Administrator", the password is the same as for the wAppLoxx Pro Control, "12345678".

Remote and cloud access configuration (see chapter 6.2)

When starting up your wAppLoxx Pro Control Plus for the first time, you can allow remote and cloud access. You can then change this permission at any time in the system settings. The changes will take effect after the control is restarted.

Cloud access is required for updates via the cloud and sending notifications via email.

Remote access allows specialist installers to carry out maintenance on the system.

E-mail notifications (see chapter 6.3)

Only one e-mail address needs to be entered to receive e-mail notifications. Then you can select e-mail notification as the reaction to an event (see chapter 10.3).

wAppLoxx Pro Repeater (see chapter 7.2)

Before repeaters are added to the system, the slave controls must be added (max. 4). The repeaters can then be assigned to the master or slave controls.

wAppLoxx Pro Cylinder (see chapter 7.3)

The walk test of the wAppLoxx Pro Cylinder has been adapted from the wAppLoxx Pro Control in order to improve the validity. Three bars are now only displayed when the signal strength is very good and one bar only when the signal strength is very poor.

General events (see chapter 10.3)

The creation of events has a new structure. First an event is selected, then the desired reaction can be configured as desired.

2. Installing the wAppLoxx Pro Control Plus

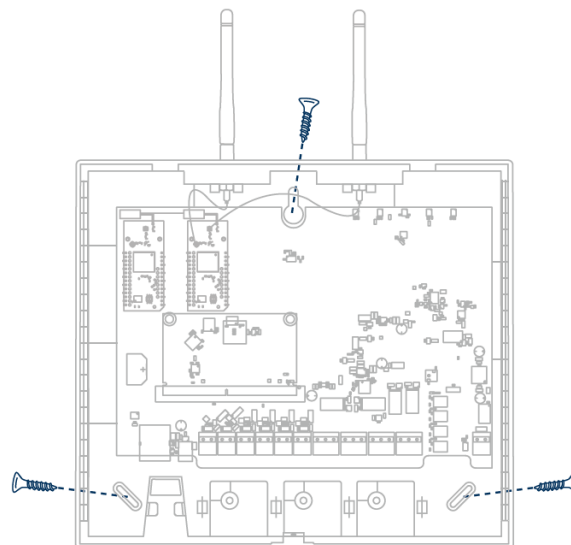
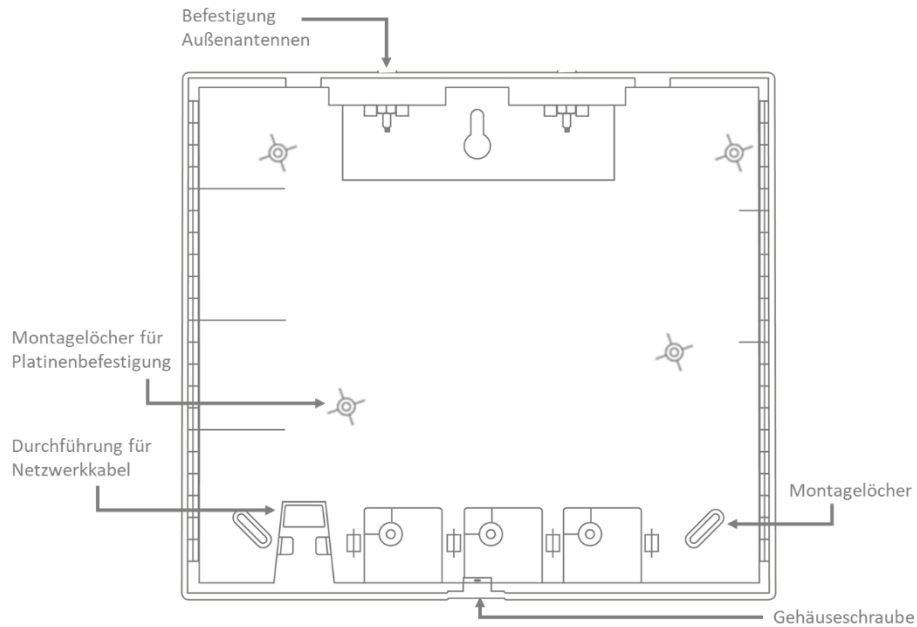

Screw the enclosed external antennas onto the connections provided for this purpose and mount the housing using three screws.

Make sure not to damage the PCB during this fitting.



Attach the housing cover. Make sure that there is sufficient distance of approx. 1m to walls and ceiling.

3. wAppLoxx Pro Control Plus connections

Variant A – Serialnumber: XXXXXXXXABA

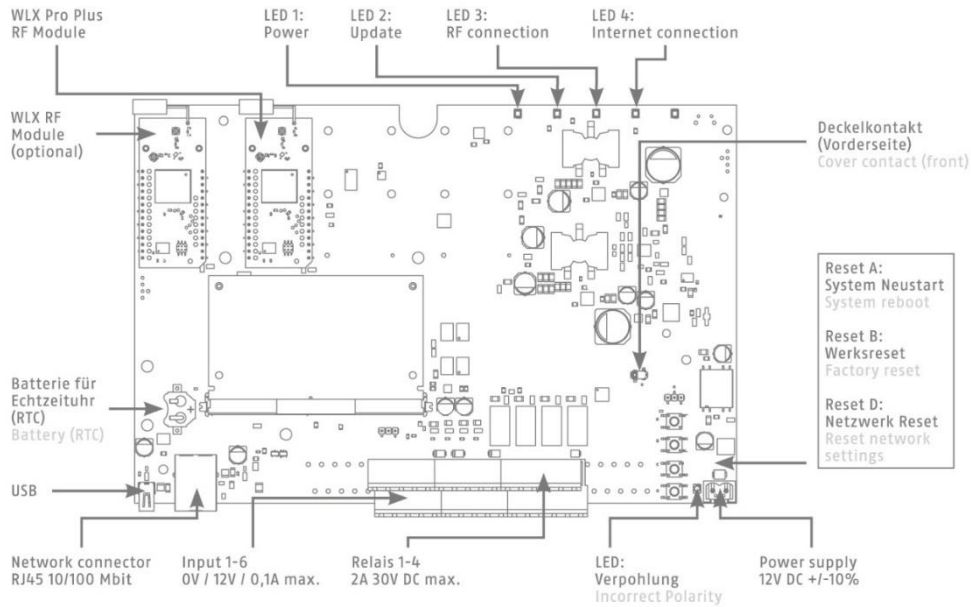

Variant B – Serialnumber: XXXXXXXXABB

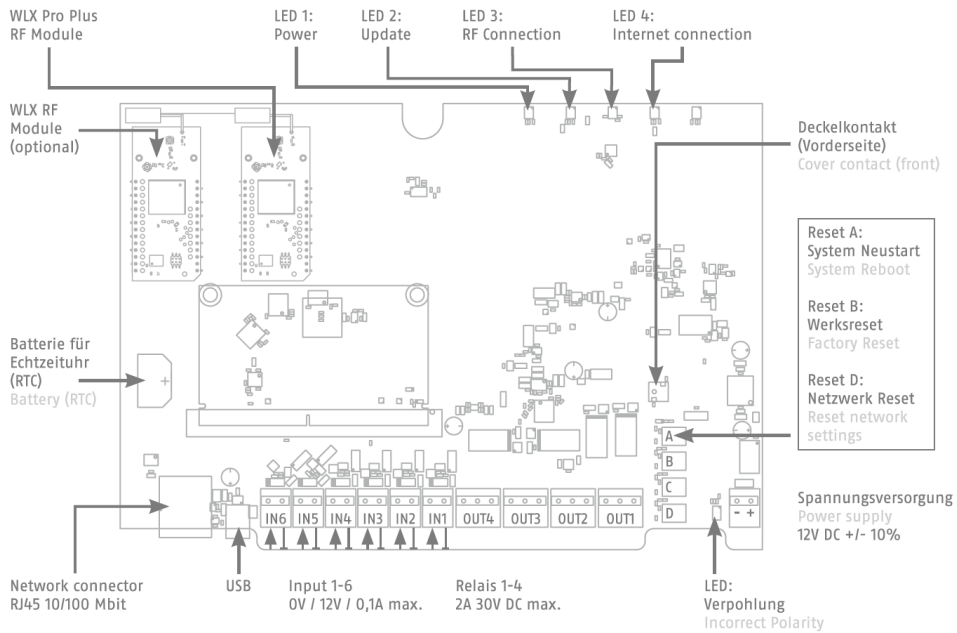

The function of the inputs and outputs is dependent on the configuration settings of the wAppLoxx Pro Control Plus.

Power supply: 12 V DC / 1.5A
Power consumption: max. 500 mA at 12 V DC
(when using the recommended power supply unit)

Attention: To ensure operation within the framework of CE approval, we recommend only using the original ABUS power supply unit. (Item no.: 505366).
We recommend switching to a new original ABUS power supply unit particularly in the event of problems with the power supply or if the existing power supply unit is defective.

Relay connector 1-4: Switching power of the changeover relay: max. 30 V DC, 2 A
The relay contact is controlled via software (whether open or closed).

Input 1-6: 12 V DC, max. 0.1 A
1. In 1-6 (+) (input active at 12 V DC)
2. GND (-)

4. LED signalling



System is rebooting (continuously red)
Master Control active (continuously green)
Slave control active (continuously yellow)



System in update mode (continuously blue)



Wireless communication between the wAppLoxx Pro Control Plus and
wAppLoxx Pro Cylinder (blue during wireless communication)



Network connection active (consistent blue)

5. Starting up the wAppLoxx Pro Control Plus using the Manager

Before you begin start-up, please insert the supplied Duracell battery CR 1220 into the battery holder on the PCB of the WLX Pro Control Plus.

Connecting the wAppLoxx Pro Control Plus to a PC/laptop via a router/switch

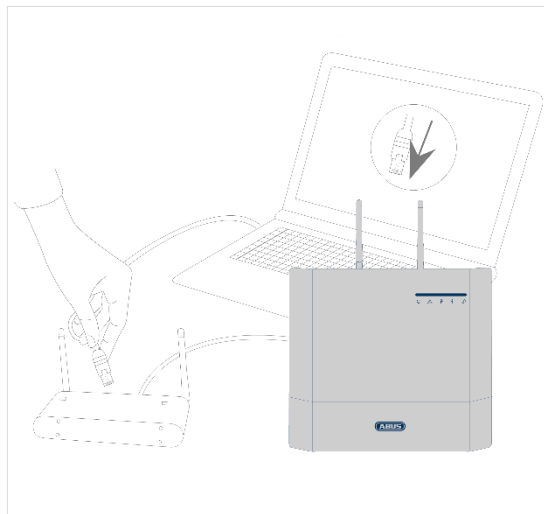

1. Connect the wAppLoxx Pro Control Plus to the router/switch.
2. Connect the wAppLoxx Pro Control Plus to the power supply. If your router is set to DHCP mode, it now assigns a new IP address to the wAppLoxx Pro Control Plus automatically.
3. Changes to the router/switch can interfere with the network functionality. Please also refer to the information in the manual supplied by the router/switch manufacturer or contact your network administrator.

Now open the wAppLoxx Pro Plus Manager software. The current software version is available for download at <https://mobil.abus.com/product/ACCO16000>. Once your wAppLoxx Pro Control Plus has been found, you can select it.

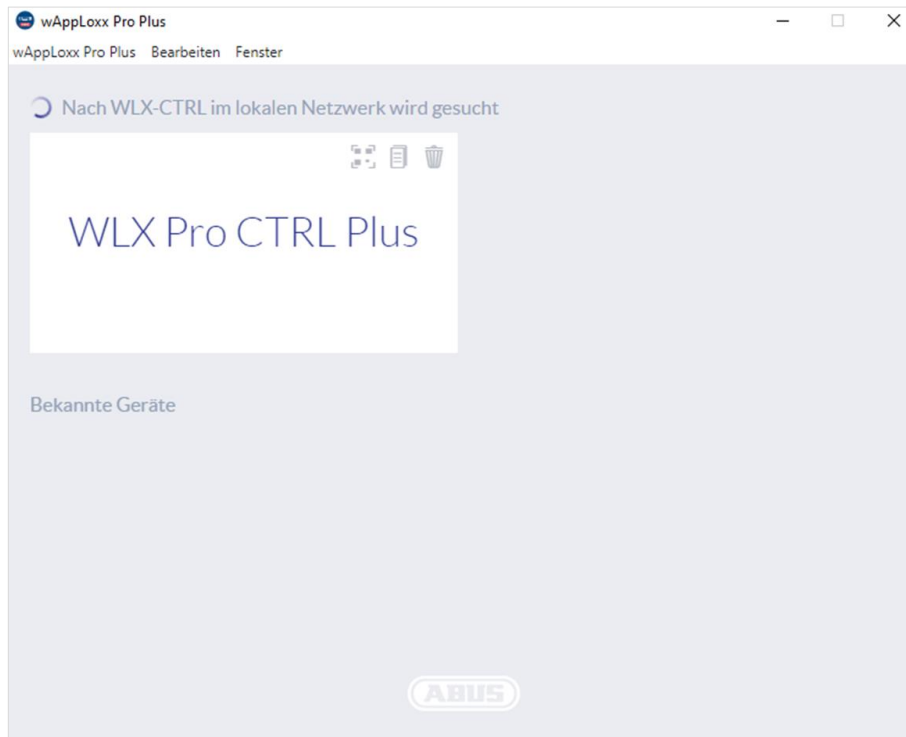

Recommended configuration

The wAppLoxx Pro Control Plus must be configured using the wAppLoxx Pro Plus Manager.

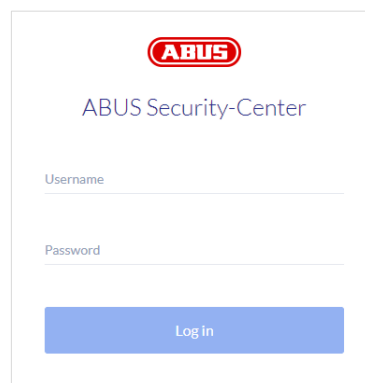

This takes you to the wAppLoxx Pro Control Plus configuration view, where you are requested to enter your user name and password.



The following access data is set by default on delivery:

User name: Administrator
password: 12345678

-  Keep the password for administrator access safe. Should you no longer have the password, the wAppLoxx Pro Control Plus will need to be reset using reset button “B” on the PCB.

Attention: All settings and configurations are lost when a factory reset is carried out. Make sure you secure the data through regular backups.

Initial start-up

After logging in for the first time, a pop-up window will appear asking you to change the administrator password. Please observe the specified minimum password requirements. You can change the password at any time via the System Settings menu item in the System Access sub-menu.

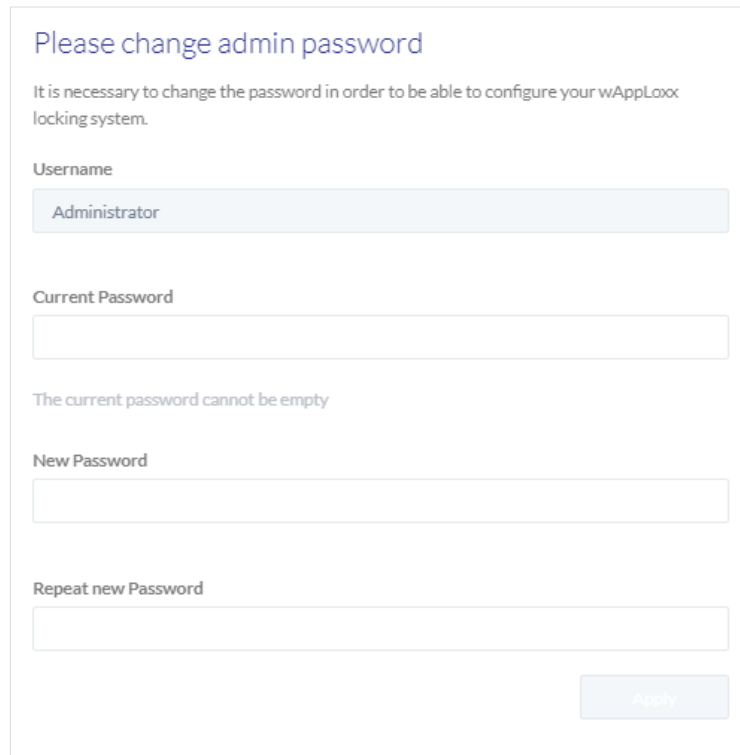

Please change admin password

It is necessary to change the password in order to be able to configure your wAppLoxx locking system.

Username

Administrator

Current Password

The current password cannot be empty

New Password

Repeat new Password

Apply

This will be followed by a pop-up in which you can agree to remote access and cloud access.

Remote access permission

Permission for remote access is required for remote maintenance access to be set up between the wAppLoxx Pro Control Plus and the PC configuration software.

Cloud access permission

To use the cloud functions of your wAppLoxx Pro Control Plus, you must allow cloud access. This is required for event notifications via e-mail and for automatic updates via the cloud.

You can change your selection at any time in the system settings under System Access (see Chapter 6.2). The changes will take effect after the control is restarted.

Cloud and Remote Access

Sehr geehrter Nutzer,
wir möchten Sie an dieser Stelle über die Datenschutzhinweise Ihres wAPPLoxx Pro Plus Systems hinweisen. Durch Aktivierung der angezeigten Remote-Funktionalitäten stimmen Sie den Hinweisen zu.

Aktivieren Sie den Fernzugriff, um Ihr WLX Pro Plus System über das Internet zu administrieren. Hierzu werden die Geräte-Konnektivitätsdaten an den dafür notwendigen Peer-to-Peer Dienst übermittelt. Sie können diese Einstellung jederzeit unter "Menü --> Systemeinstellungen / Systemzugang" ändern. Ist die Funktion deaktiviert, kann das System nur innerhalb des lokalen Netzwerks administriert werden.

Remote Access

Aktivieren Sie die Cloud-Funktionalität, um Benachrichtigungen (E-Mail) und automatische Updates (OTA Firmware Update) zu erhalten. Unter Verwendung des ABUS-Cloud Portals können grundlegende Telemetriedaten eingesehen werden. Sie können diese Einstellung jederzeit unter "Menü --> Systemeinstellungen / Systemzugang" ändern. Ist die Funktion deaktiviert, steht die E-Mail Benachrichtigung, OTA-Updates und Geräteinformation im Portal nicht zur Verfügung.

Cloud Access

[Data Protection Information](#) [Terms Of Use](#)

[Save](#)

Alternative connection method via IP address

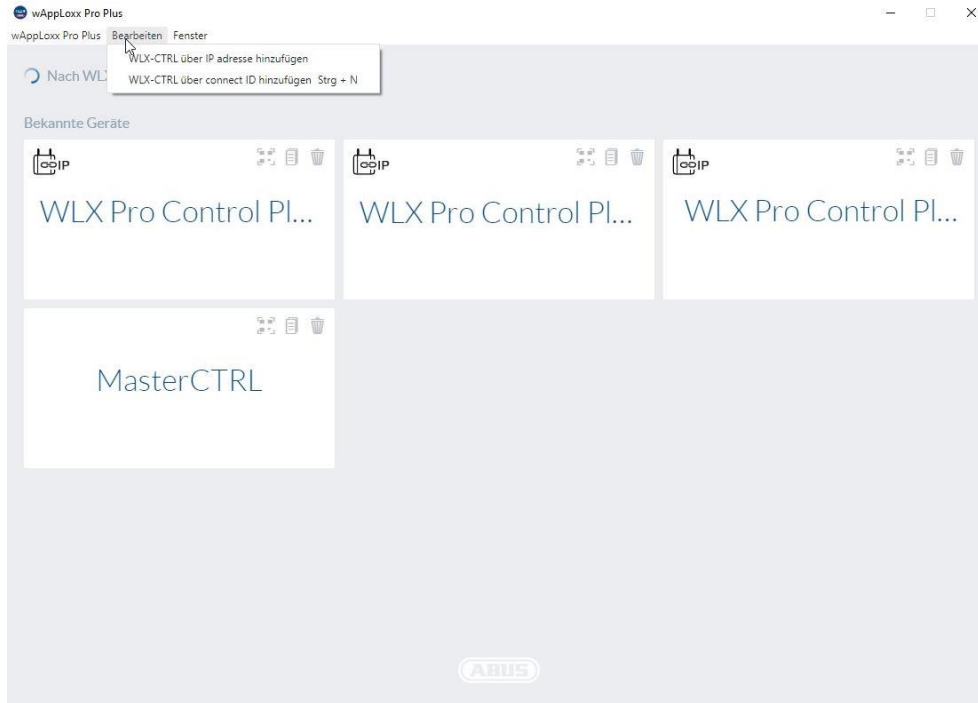

From version 1.3.0 of the wAppLoxx Pro Plus Manager, controls can be added to the Manager via IP address. This may be necessary if an automatic discovery of available controls via mDNS cannot be guaranteed on the network side.

To do this, select "Add WLX-CTRL via IP address" under the "Edit" tab and enter the IP address of the corresponding control manually.

6. System settings

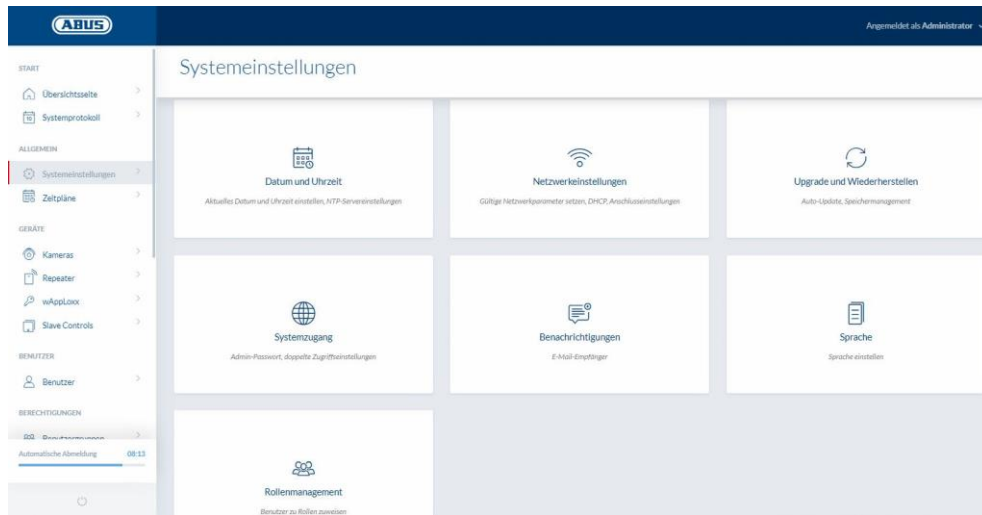

6.1. Date and time



It is essential to configure the date and time to ensure the device functions correctly.



The date and time must always be correct to ensure smooth operation. Check that the date and time are correct during every operation.

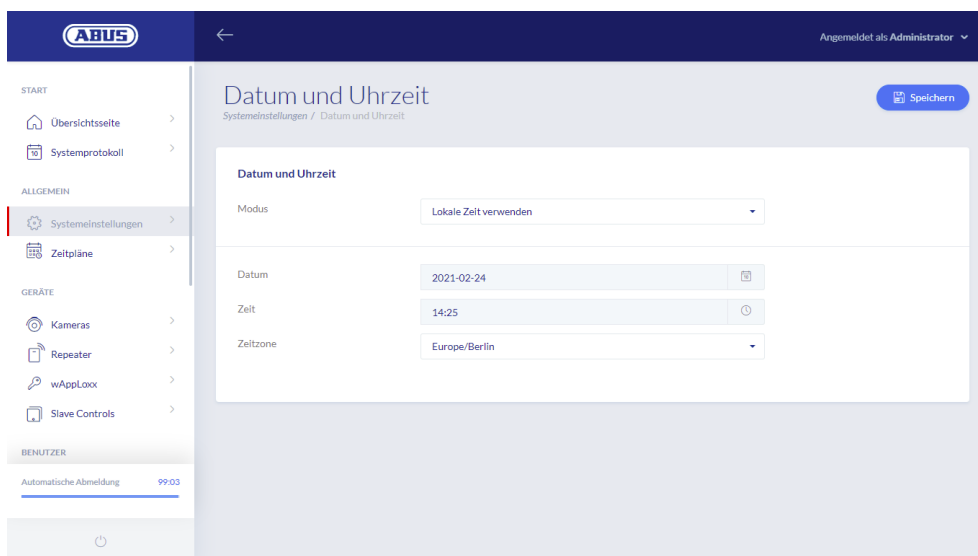

Mode:

1. Use time from local system Select this setting to synchronise the system time with your PC. The system's internal clock has an accuracy of ± 10 minutes per year.

2. Use NTP Server Select this setting to use an NTP server that synchronises the system time with a time server. This setting only works when the system is connected to the network.

NTP Server

Select an NTP server. In Germany, we recommend the NTP server: ptbtime1.ptb.de.

Update interval

Select an interval in which the time is synchronised via the NTP Server.

Time zone

Select the time zone in which the wAppLoxx Pro Control Plus is located.



The wAppLoxx Pro Control Plus must have access to the internet for this to be possible.

3. Manual Select this setting to adjust the system time manually.

Date/Time

Select the current date and time.

Time zone

Select the time zone in which the wAppLoxx Pro Control Plus is located.

6.2. System access

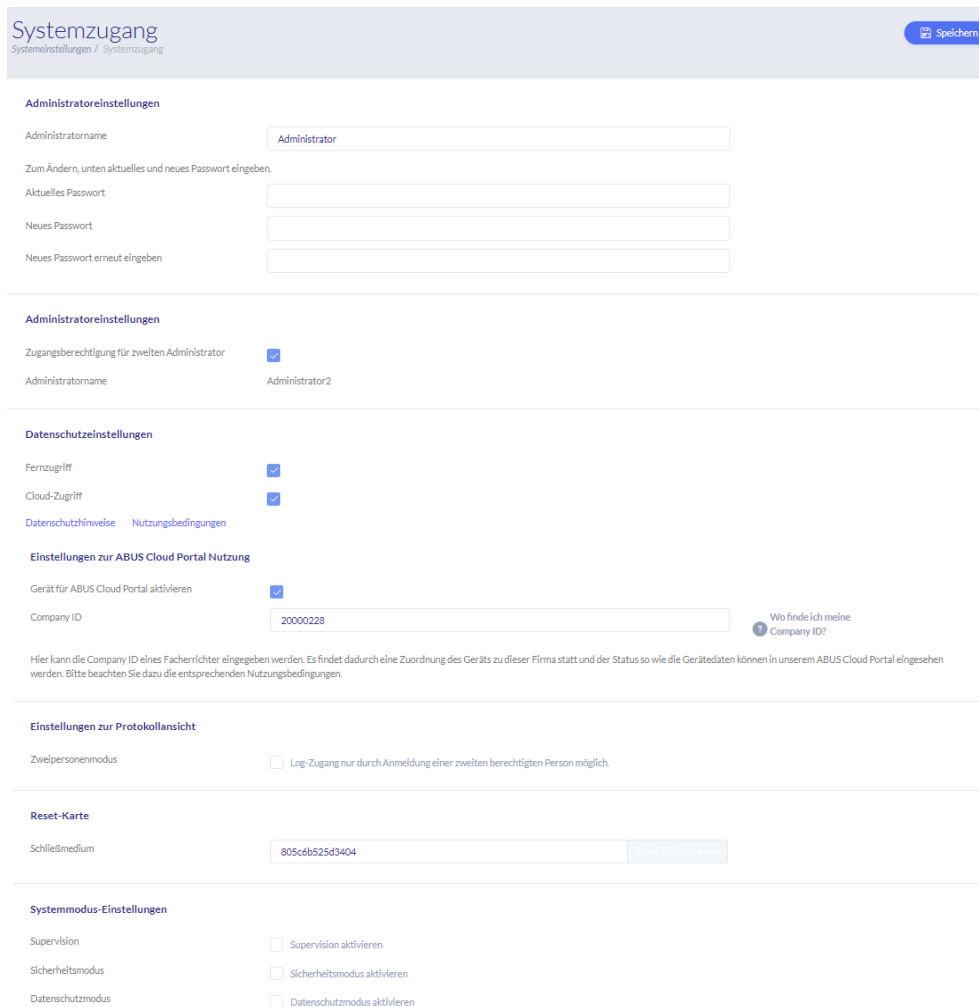

The screenshot shows the 'Systemzugang' (System Access) settings page. It is divided into several sections:

- Administratoreinstellungen**: Fields for 'Administratorname' (Administrator), 'Aktuelles Passwort' (Current Password), 'Neues Passwort' (New Password), and 'Neues Passwort erneut eingeben' (Re-enter New Password).
- Administratoreinstellungen**: A section for 'Zugangsberechtigung für zweiten Administrator' (Access rights for second administrator) with a checked checkbox, and 'Administratormane' (Administrator name) set to 'Administrator2'.
- Datenschutzeinstellungen**: 'Fernzugriff' (Remote access) and 'Cloud-Zugriff' (Cloud access) are both checked. There are links for 'Datenschutzhinweise' and 'Nutzungsbedingungen'.
- Einstellungen zur ABUS Cloud Portal Nutzung**: 'Gerät für ABUS Cloud Portal aktivieren' (Activate device for ABUS Cloud Portal) is checked. 'Company ID' is set to '20000228'. A link 'Wo finde ich meine Company ID?' is present.
- Einstellungen zur Protokollansicht**: 'Zwelpersonenmodus' (Two-person mode) is unchecked, with a note: 'Log-Zugang nur durch Anmeldung einer zweiten berechtigten Person möglich'.
- Reset-Karte**: 'Schlüsselmedium' (Key medium) is set to '805c6b525d3404'. A 'Reset-Karte löschen' button is visible.
- Systemmodus-Einstellungen**: Three checkboxes are present: 'Supervision aktivieren', 'Sicherheitsmodus aktivieren', and 'Datenschutzmodus aktivieren', all of which are currently unchecked.

Administrator Settings

Enter a new username and password for the administrator.



Be sure to take security guidelines into consideration.



Please ensure the administrator access is changed after initial commissioning.

Administrator 2 Settings

If you want to create another user with administrator rights, activate "Second Administrator Access".



Be sure to take security guidelines into consideration when creating a username and password.

Privacy Policy Settings

Remote access: Permission for remote access is required for remote maintenance access to be set up between the wAppLoxx Pro Control Plus and the PC configuration software.

Cloud access: To use the cloud functions of your wAppLoxx Pro Control Plus, you must allow cloud access. This is required for event notifications via e-mail and for automatic updates via the cloud.



Changes to the remote and cloud access settings will only take effect after the control has been restarted.

Settings for ABUS Cloud Portal use

Activate Abus Cloud Portal use and enter your Company ID as a specialist installer to set up remote maintenance access.

Log view settings

Selecting the two men role mode means the event log can only be accessed when a second user is registered in the log menu.



The two men role mode only functions with access via the website. It is not possible to view the logs when accessed via the app with the two men role mode activated.

Reset Card

In order to prevent unauthorised unpairing of the cylinder by third parties, a reset card must be programmed. The ID of this reset card is then written on each cylinder used in the system (analogous to a fallback user) and is thus a unique identification medium.

This ensures that a cylinder can only be reset using the unique reset card programmed by you. Please keep the reset card in a safe place. Should you lose the reset card, the administrator can create a new one.

After integrating all wAppLoxx Pro Plus slave controls and wAppLoxx Pro Repeaters, register your reset card. To do this, you must first create a wAppLoxx cylinder as a reader, then you can register the reset card by clicking "Scan reset card" (see Chapter 7.3).

System mode settings

Supervision: When supervision mode is activated, cylinders will be monitored every 24 hours to determine whether they are still available or not. You can then select an action in the event that a cylinder is not available under the “Events” menu.

Security mode: When secure mode is active, only ABUS Mifare DESfire EV1 locking media will be supported.
If secure mode is disabled, the ACCO16000 product variants and Mifare Classic and Mifare DESFire EV1 tags from ABUS, or another provider, can also be read.
The possible locking media for operating older cylinder variants are listed in chapter 1.5.

Privacy policy mode: When privacy policy mode is activated, all log entries older than 42 days will be automatically deleted.

Device name

Select the device name used to identify your wAppLoxx Pro Control Plus on the network/in the app. The device name can only be changed after adding a reset card.

6.3. Notifications

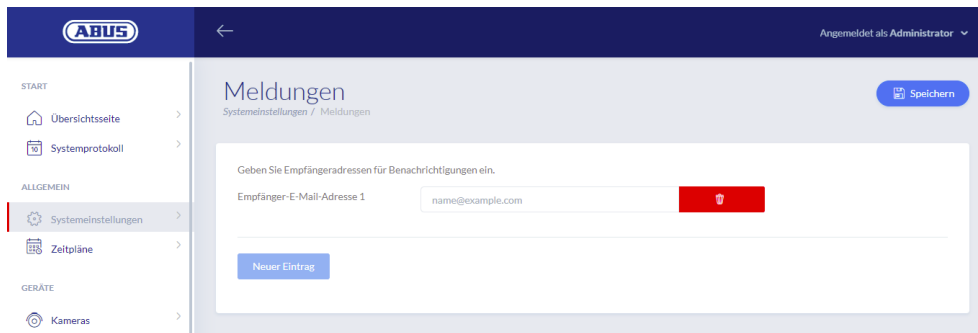

An e-mail account from an e-mail provider (such as GMX) is required to enable e-mail notifications. You can use an existing account or create a new one for your Control.

Enter your e-mail address under Recipient e-mail address 1 and then click "Save". Further e-mail addresses can be added using the "Add item" selection field. You can then select your e-mail address as the event response (see Chapter 10.3).

6.4. Network settings

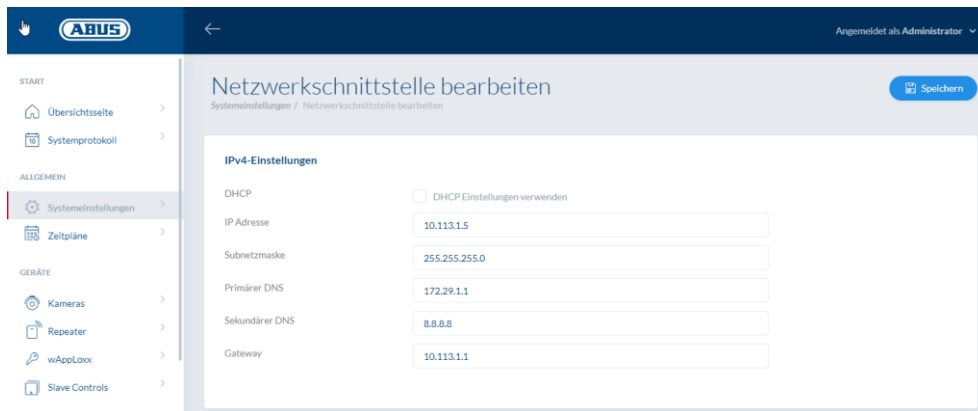

Use DHCP settings

Check this box if the wAppLoxx Pro Control Plus is connected to a router with DHCP function. All connection data is now automatically assigned by the router.

If no DHCP function is available, you can remove the tick and enter the connection data manually. If necessary, consult your network administrator.

6.5. Language

Here you can select the desired language for the user interface of the wAppLoxx Pro Control Plus.

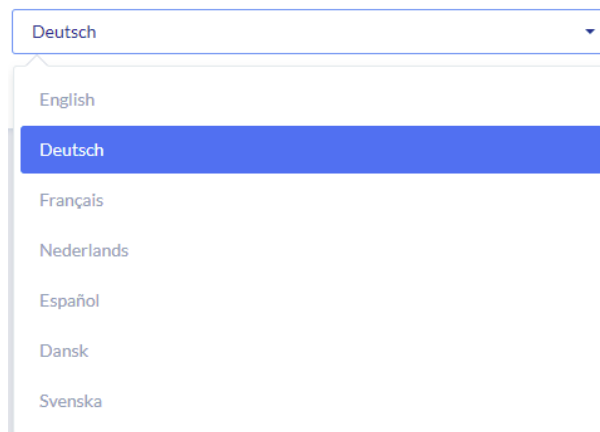

6.6. Upgrade and restore

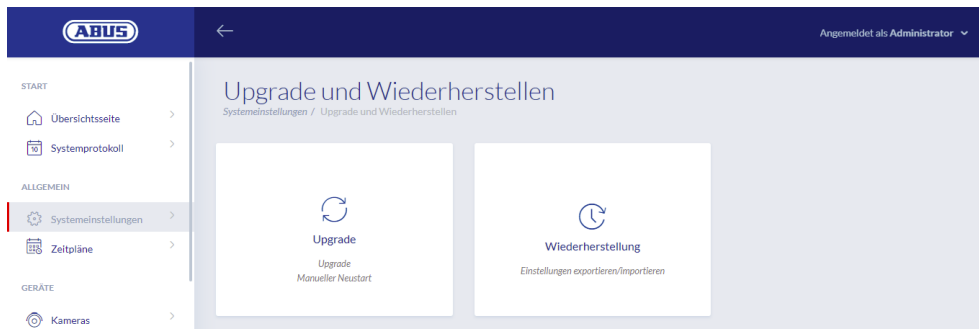

Automatic firmware update

If you have allowed cloud access, you will receive a notification on your dashboard as soon as new firmware updates are available. Click on the notification to automatically download and install the updates.

Manual firmware update

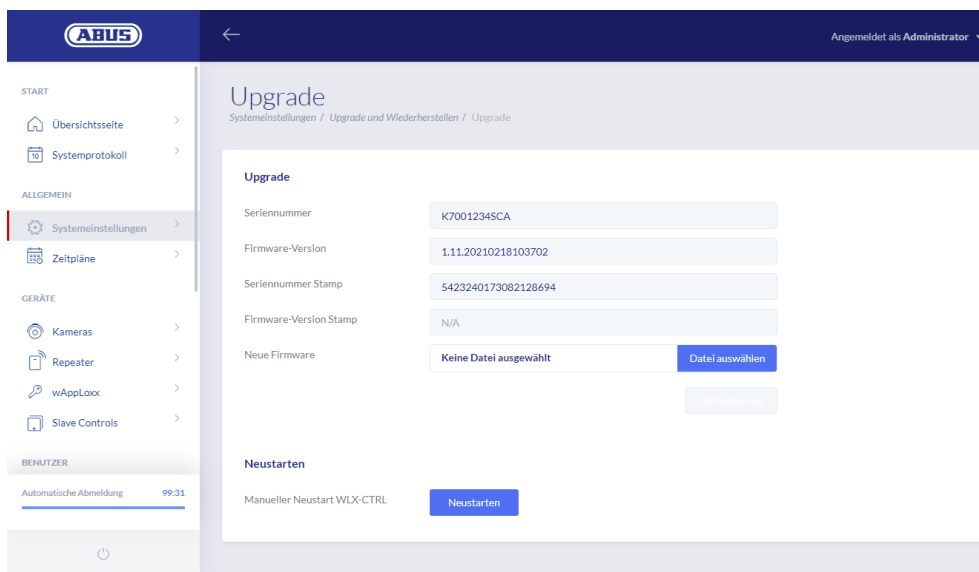

The latest firmware for wAppLoxx Pro Control Plus is available for download from www.abus.com.



We recommend always using the latest firmware. You can find them under the following link in the "Downloads" tab:

<https://mobil.abus.com/product/ACCO16000>

To perform an update, download the file (*.iso) with the new firmware version and select this using the button. Click “Update” at the top right. This performs the update and restarts the wAppLoxx Pro Control Plus automatically.



The wAppLoxx Pro Control Plus must not be disconnected from the power supply during the update process.

To restart the wAppLoxx Pro Control Plus manually, select the “Restart” button.

Restore settings

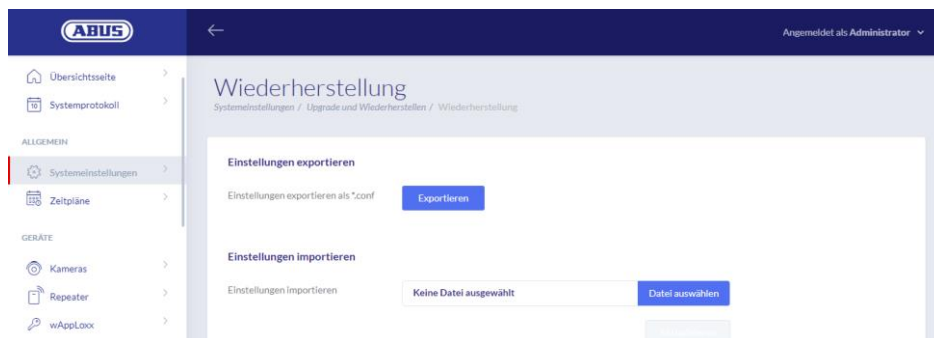

If you would like to save your settings or transfer them to another wAppLoxx Pro Control Plus, you can export them to a configuration file (*.conf). This file contains all settings with the exception of all cylinders, repeaters and slave controls. These must be registered again from scratch. To import a configuration file, select this using the “Select file” button and complete the process by clicking “Import”.

6.7. Role management

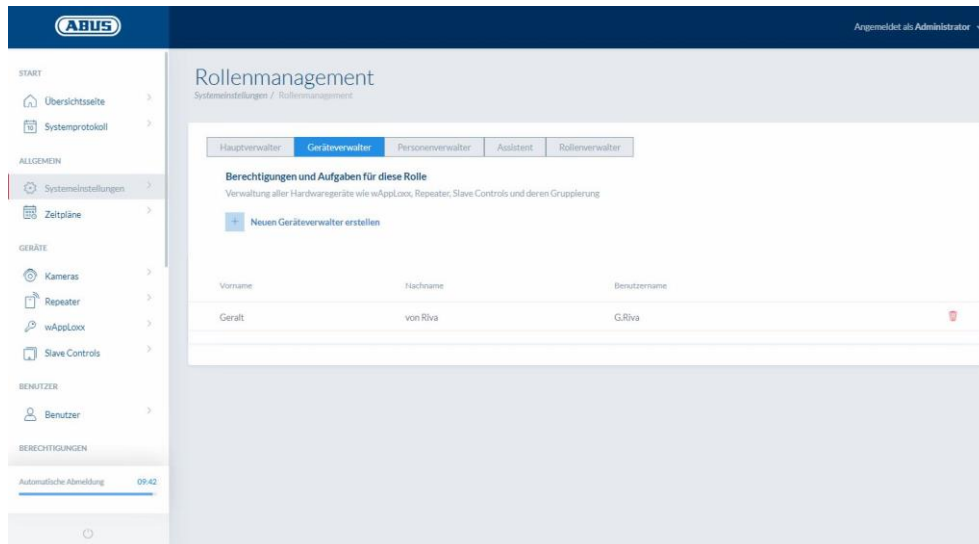

From Control SW version 1.5x in conjunction with WLX PP Manager V. 1.4.0 it is possible to create users with different roles. These users have limited administration rights in the system according to their role. The authorisations of the administrator remain unchanged. Users of the following roles can be created:

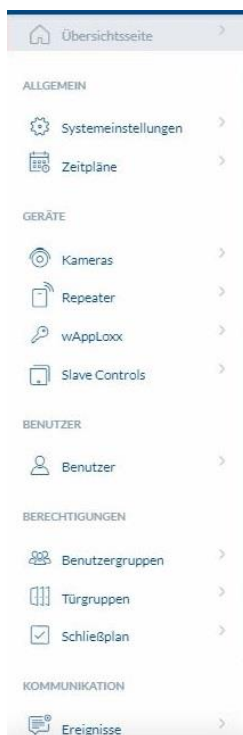

Chief administrator

- The chief administrator has full administration rights for the system, but no access to the system log and therefore is not allowed to create users with log access. Important system messages are displayed to him/her in the dashboard (e.g. battery warnings), or can be sent via email notifications.

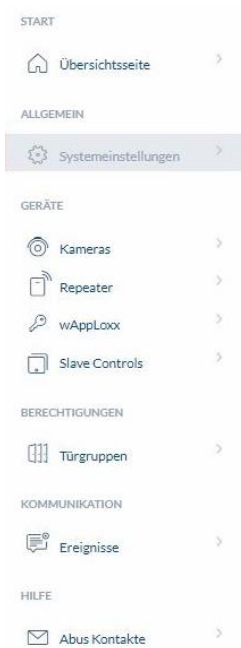

Device administrator

- The device administrator has administration rights reduced to the administration of hardware and may therefore teach-in door components, repeaters and controls, as well as edit all system settings. In addition, the setting for the interface to the alarm system and the setting of the inputs and outputs of the control can be managed.

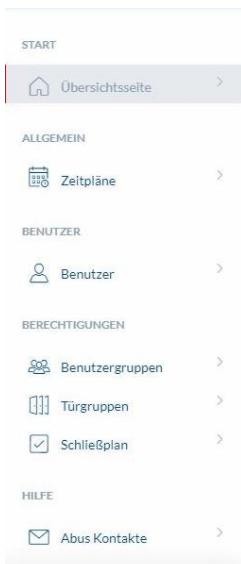

Personal administrator

- The person administrator has reduced administration rights to the administration of user/locking authorisations. Users can be created and locking media can be taught in. In addition, user groups, time schedules and locking authorisations can be assigned. The personal administrator has no administrative rights for door components and other hardware.

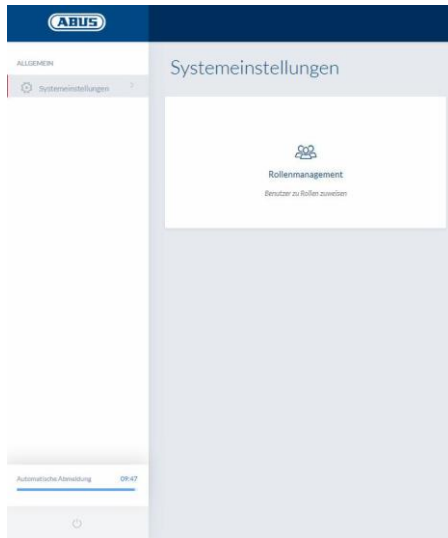

Role administrator

- The role administrator does not have any administrative rights in the system, his task is to create and manage users of the roles described here. Besides the administrator, only the role administrator can create users of the new roles.

Assistant / Read-Only User

- The assistant can see all settings, components and users in the system, but cannot make any changes. The system log, however, cannot be viewed. If the two-person mode (four-eyes principle) is activated, the assistant can enable the view of the system log together with a user with log access.

General explanations

Up to 10 users can be created for each administrator role. The administrator and the role administrator can create users for the various roles. For this purpose, a user name and a password are initially assigned. The newly created user is then prompted to change his password when he logs in for the first time.

It is not possible for two users with the same administrator role or in combination with the administrator or the main administrator to log in at the same time.

6.8. External access to the wAppLoxx Pro Plus system

In addition to the administrator, users can also connect to the wAppLoxx Pro Control Plus via web or app. To do so, a user with web access must have been created as described in Chapter 8.2.

Any number of devices can be used to access the wAppLoxx Pro Control Plus. If a desktop computer or Notebook is to be used to access the WLX PRO CTRL PLUS, we recommend the wAppLoxx Pro Plus Manager for this. It is available for download via the following link:
<https://mobil.abus.com/product/ACCO16000>

The wAppLoxx Pro Control Plus app can also be operated from mobile devices using the wAppLoxx Pro Plus app (see chapter 12). The app is available for download from the AppStore (iOS) or the Google Play store (Android).

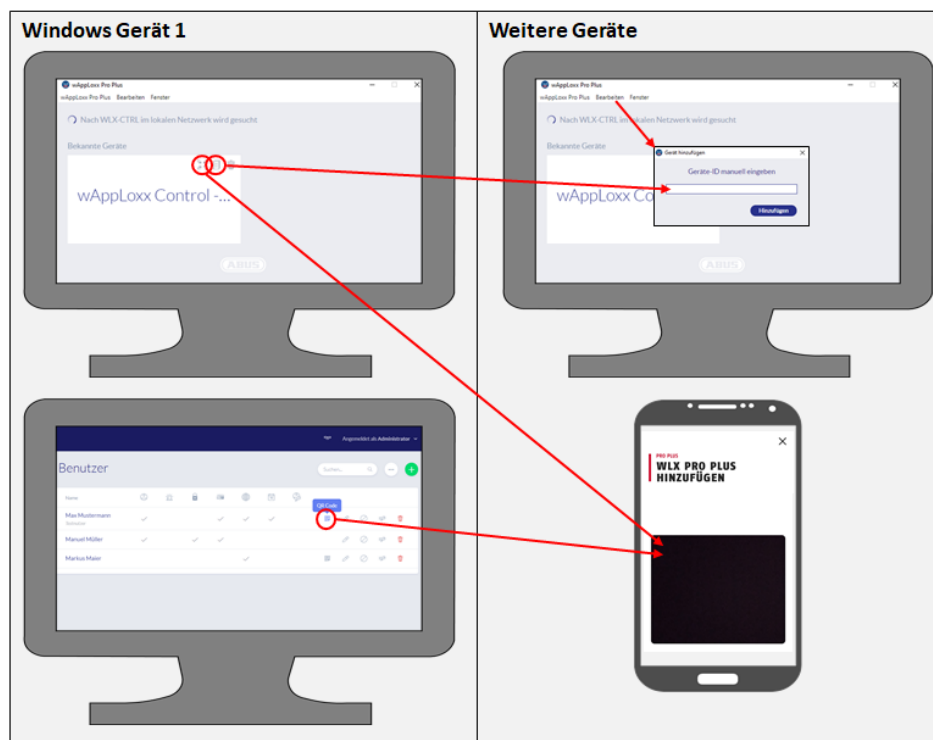

If the wAppLoxx Control is in the same local network, it will automatically appear in the wAppLoxx Pro Plus Manager. To add the Control manually, the ID of the Control can be copied in the Manager and manually pasted in the Manager of another device under "Edit".

If the WLX PRO CTRL PLUS is to be accessed with a smartphone or tablet, the QR code from the Manager, the administrator interface or the user interface can be scanned in the wAppLoxx app (see chapter 12).

If a mobile device has already been used to access the wAppLoxx Pro Control Plus via the app, then a QR code can be generated and scanned by other devices on this device or in the app via “SHARE DEVICE”.



For security reasons, the QR codes are only valid for one week and each QR code can only be used once.

7. Configuration of the components

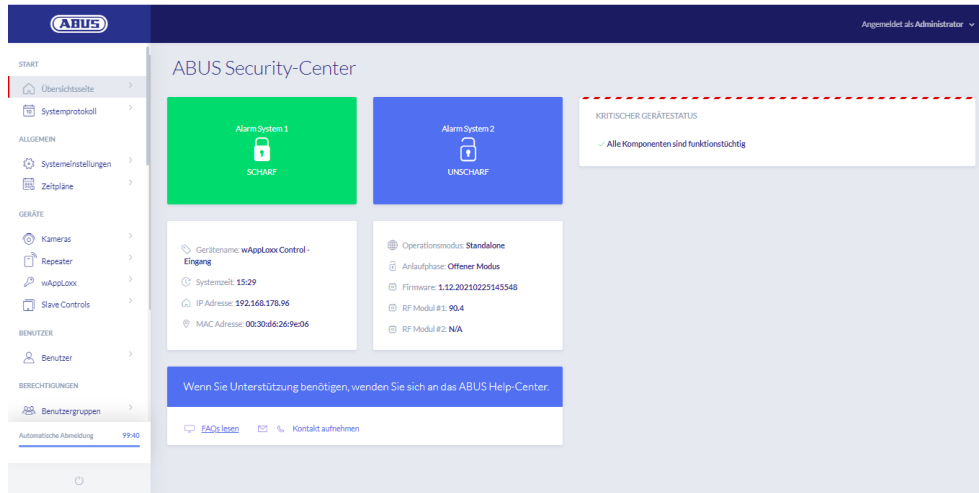

On the overview page of the main menu, you can find an overview of all the important information about your wAppLoxx Pro Control Plus. Current messages are displayed under the item "critical device status" (e.g. battery warnings or a loss of connection).

Make sure you have the latest firmware on your wAppLoxx Control Pro. If cloud access has been allowed, you will receive a message if a new firmware version is available. You can find more information about the firmware update under Section 6.6 "Upgrade and restore".

7.1. wAppLoxx Pro Plus Slave Control

wAppLoxx Pro Control Plus cascading

The cascading function allows you to connect up to five wAppLoxx Pro Control Plus in master-slave mode in a local network. The master-slave function is used to increase the range of wireless coverage.

wAppLoxx cylinders are thereby directly programmed at the master control into the master or slave control or into an associated repeater. Account management is only carried out at the system master control. All data such as user, locking plan, etc. are transferred from the master control to the slave control.

Setting up a master/slave system



The master and slave controls must use the same firmware version and good network communication between the master and slave controls is required for smooth installation.



A fixed IP address must be set in the master control in order to add a slave control. It is not possible to subsequently switch to DHCP or to change the fixed IP address.



The control to be used as a "slave control" must not be configured before it is added. For a control to be added as a slave, only the IP address of the control may be changed. All other settings ensure that a factory reset must be carried out in order to get the control back into a cascadable state.

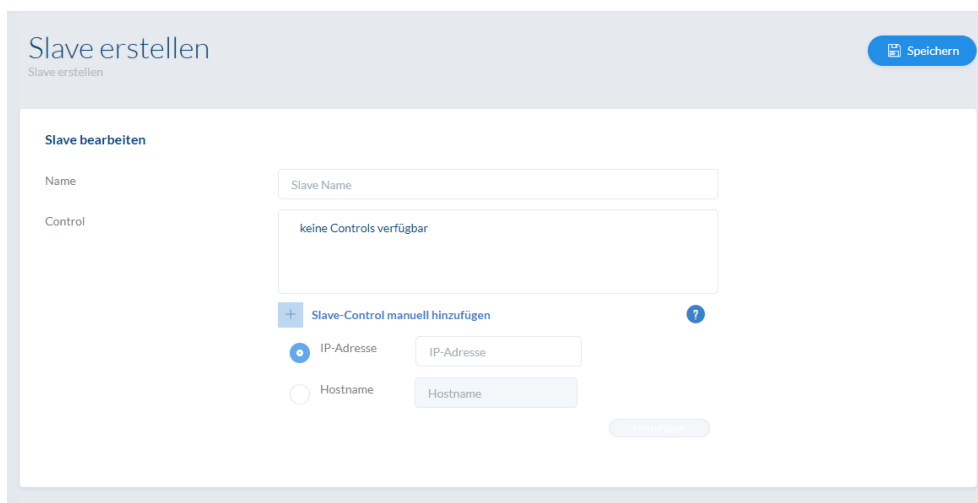

1. Establish the power supply for all slave controls.
2. In the master control, go to the Slave Controls menu item and click on the green plus sign to add slave controls. If DHCP is activated, an error message will appear because cascading is only possible with a fixed IP address.
3. Select the desired slave control and assign a name, then click "Save". The power LED of the slave control then lights up yellow continuously.
4. If the control is not automatically found in the network, the IP address or the host name of the slave control can be provided manually. After entering the data, the control appears in the list.
5. Repeat the procedure to register further slave controls.



If you want to integrate wAppLoxx Pro Repeaters into your system, add them only after integrating the slave controls (see Chap. 7.2).

If you want to expand your system with a slave control, the repeaters and cylinders registered to another control will remain unaffected.



Changes are generally exchanged directly between the master and slave controls. In the event of a poor network connection, this communication can become disrupted or delayed. Regular synchronisation of data therefore also takes place once per minute.



This includes your system's reset card which was stored in the master control and is valid for the slave controls.



In the event of a failure, the master control can continue operating the slave controls independently.

7.2. wAppLoxx Pro Repeater



If a wAppLoxx Pro Repeater is to be registered to a slave control, it must first be integrated into the master control.

Start-up without batteries

1. Install the antenna
2. Clamp and plug in power supply unit
3. All LEDs will light up for 2 sec.
If LED 1 is lit steadily, the repeater is ready to install.

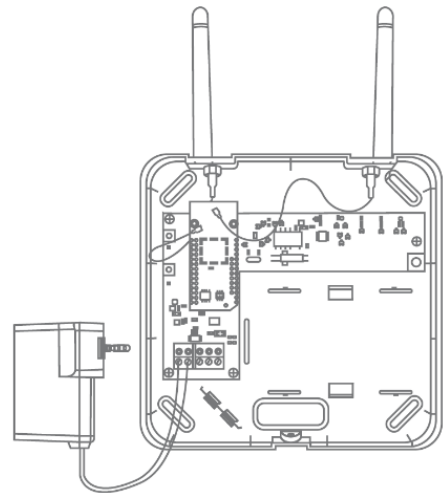

Start-up with batteries

1. Install the antenna
2. Insert battery and connect battery cable to the BAT:
3. Clamp and plug in power supply unit
4. All LEDs light up for 2 seconds. When LED 1 lights up continuously, the repeater is ready to install.
5. The power supply unit can be removed for the walk test -
LED 1 lights up red

You can find further information about the walk test in this chapter under the step Walk Test.

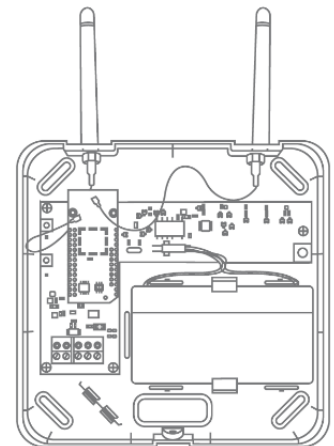

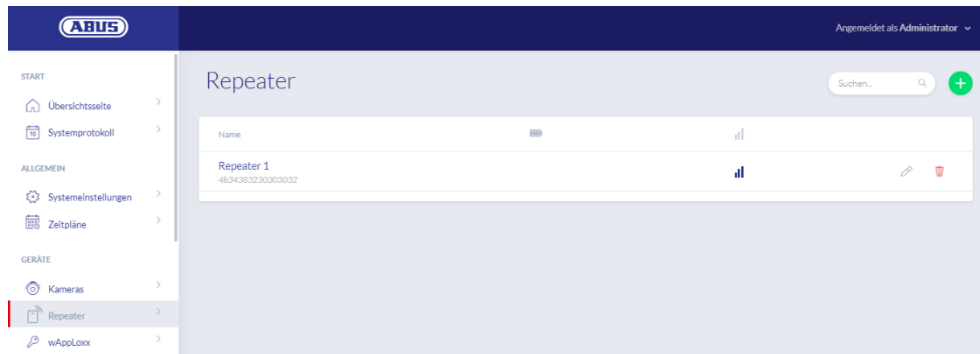

All repeaters are displayed with their signal strength and battery status under the menu item Repeaters. This also includes Edit, Lock and Delete symbols.



Signal strength

Every time communication takes place between the wAppLoxx Pro Repeater and wAppLoxx Pro Control Plus, the most recent signal strength measurement is displayed as a bar chart.



- | | |
|---------|---|
| No bar: | no wireless connection to the wAppLoxx Pro Repeater |
| 1 bar: | weak – operation not recommended |
| 2 bars: | good |
| 3 bars: | Good |

Register repeater

1. Click on the green plus sign in the repeater menu to create a new wAppLoxx Pro Repeater.
2. Assign a name and select the control to which the repeater is to be registered.
3. Click "Register device"

4. Press pairing button “A” for 3 sec. – LED 2 will flash
5. The repeater will now connect to the wAppLoxx Pro Control. This process may take a few seconds.
6. Successful programming is confirmed by LED 2 lighting up blue.

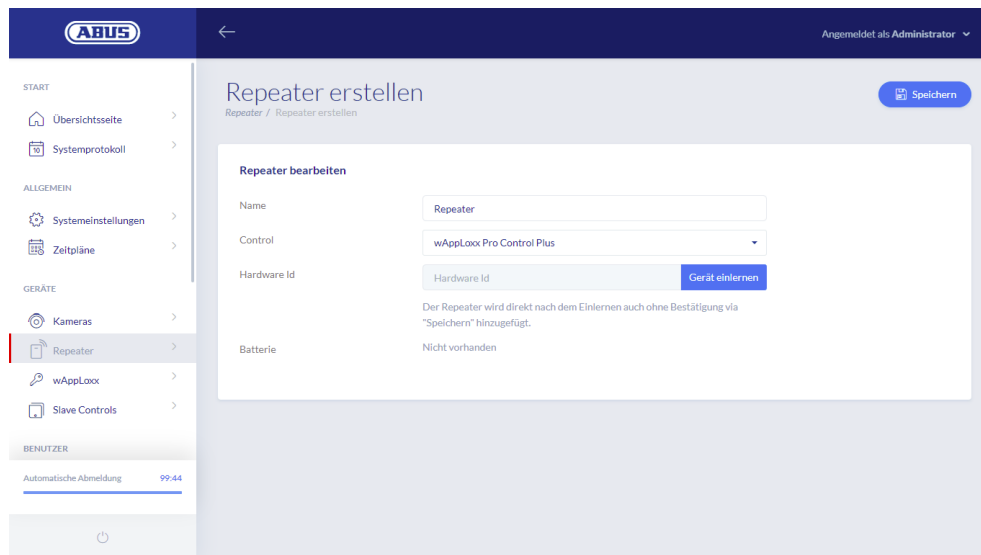

Walk Test

Press the walk test button “B” on the repeater to start a walk test. Once the signal strength is good or better (2 bars), you can then install the wAppLoxx Pro Repeater in the desired position.

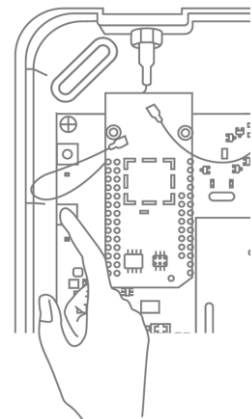
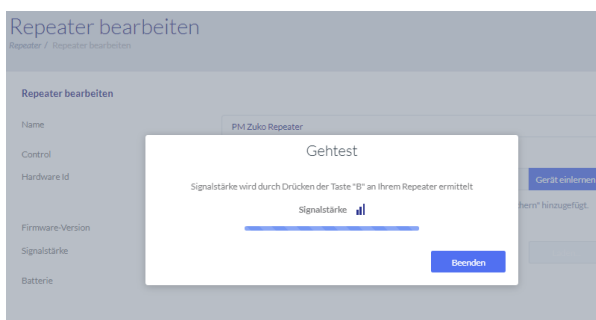

We recommend performing the walk test with the battery.

Unpairing the repeater

Via repeater pairing button "A":

To unpair the wAppLoxx Pro Repeater, hold pairing button "A" until unpairing is confirmed by the LED signal.

The repeater will automatically be removed from the wAppLoxx Pro Control Plus.

Via wAppLoxx Pro Control Plus:

The wAppLoxx Pro Repeater will automatically be removed from the wAppLoxx Pro Control Plus by pressing the "Delete" button. There must be a wireless connection in place to do this. Otherwise the wAppLoxx Pro Repeater must be manually unpaired by pressing pairing button "A".

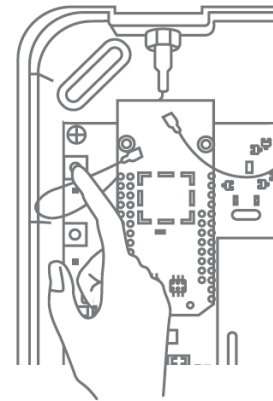

7.3. wAppLoxx Pro Cylinder



If a wAppLoxx Pro Plus Slave Control or a wAppLoxx Pro Repeater should be integrated into the master key system, it must be programmed first, as associated wAppLoxx Pro components must be assigned to a slave control or a repeater during programming.

A subsequent change in the assignment of a cylinder to its repeater or its control can only be reset after unpairing.

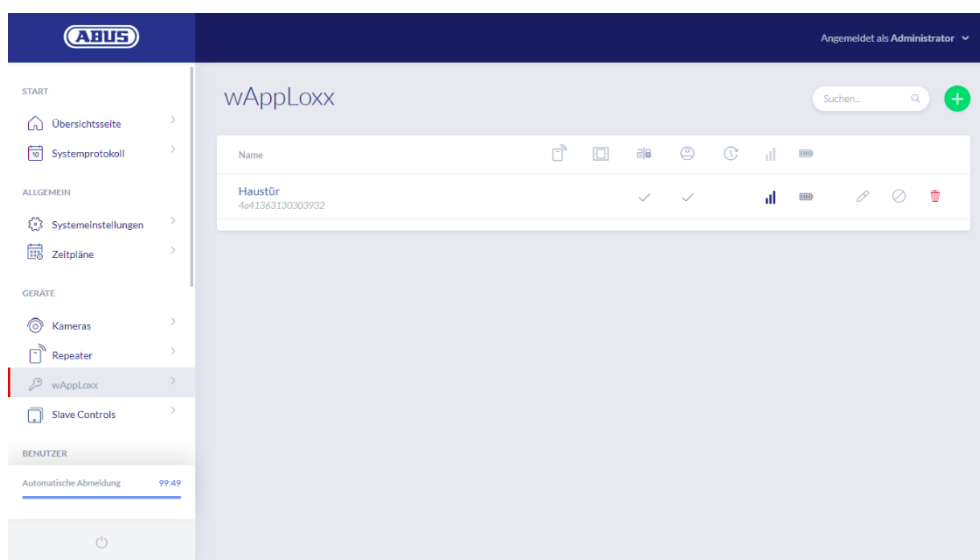

All wAppLoxx Pro door components that have been created are displayed under the menu item wAppLoxx with their signal strength and battery status. This also includes Edit, Lock and Delete symbols.

Battery status



Battery change



Lock+
Unlock



Delete



Edit





The “battery change” symbol appears if the wAppLoxx Pro Cylinder was disconnected from the power supply. Confirm the battery change by clicking “Yes” to reset the counter for the number of cylinder openings (cycles).

If the battery was not replaced with a new one, select “No” to continue counting the openings (cycles).

Making the wrong selection here can mean that the cylinder does not give a battery warning at the right time and that it will no longer be possible to open the door.

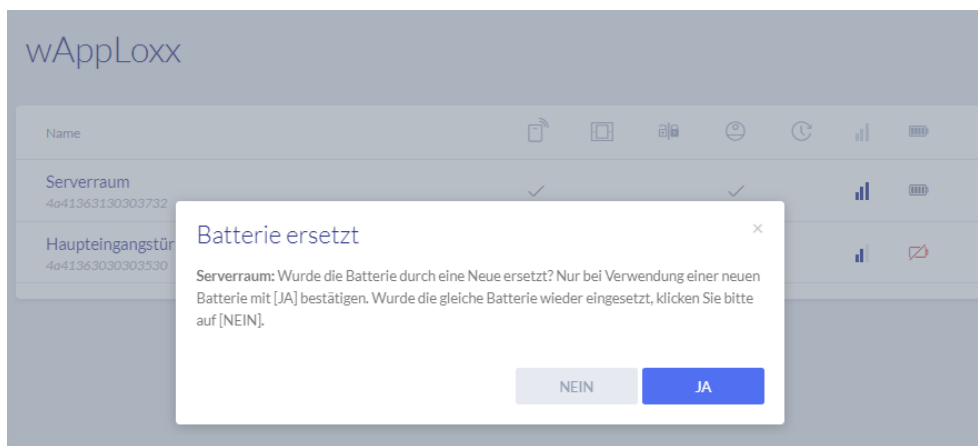

Signal strength

Every time communication takes place between the wAppLoxx Pro Cylinder and wAppLoxx Pro Control Plus, the most recent signal strength measurement is displayed as a bar chart.



- No bar: no wireless connection to the wAppLoxx Pro Cylinder
- 1 bar: weak
- 2 bars: good
- 3 bars: Good

Battery

Every time communication takes place between the wAppLoxx Pro Cylinder and wAppLoxx Pro Control Plus, the most recent battery status measurement is displayed graphically.

- Battery full: Battery status OK
- Battery empty: Battery must be replaced soon

Your wAppLoxx Pro Control Plus includes a system card and a reset card on delivery. These cards have the following functions:

System card

Since the wAppLoxx Pro Cylinder does not have a mechanical reset button, the cylinder is set to programming or unpairing mode by presenting the system card. The system card can be used for any wAppLoxx Pro Cylinder.

Reset card

In order to prevent unauthorised unpairing of the cylinder by third parties, a reset card must be programmed. The ID of this reset card is then written on each cylinder used in the system (analogous to a fallback user) and is thus a unique identification medium.

This ensures that a cylinder can only be reset using the unique reset card programmed by you.

Please keep the reset card in a safe place. Should you lose the reset card, the administrator can create a new one.

Reset cylinder

The cylinder is reset with the reset card (or with a fallback tag) and the system card. First hold the system card in front of the cylinder and then, while the cylinder is still flashing, hold the reset card (or a fallback tag). A cylinder has been reset when it is permanently coupled and lights up green when turned.

Click on the green plus sign in the wAppLoxx menu to create a new wAppLoxx Pro Cylinder.

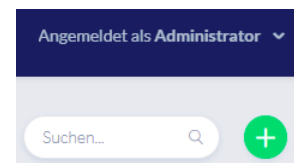

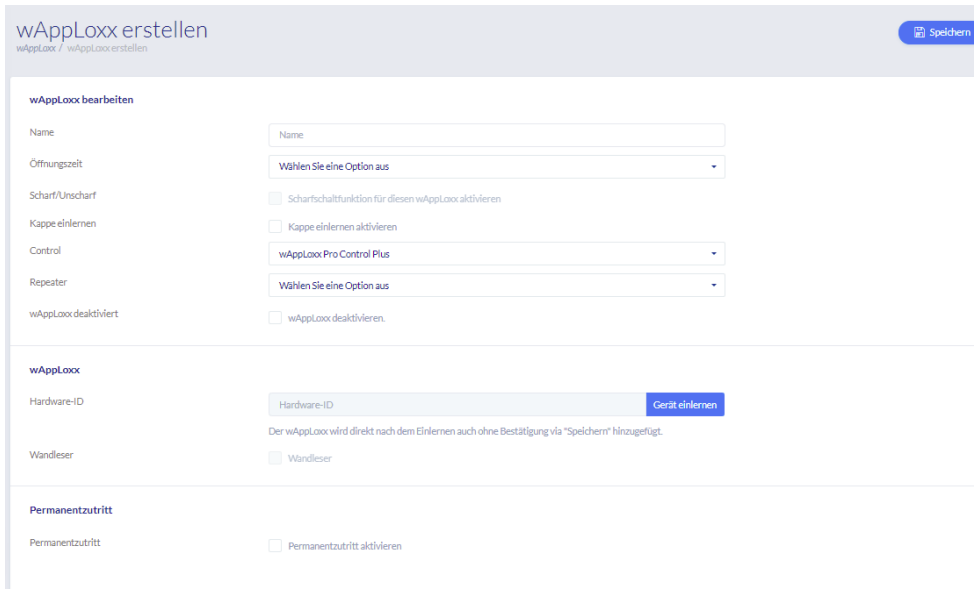

Name

Enter the name of the door/wAppLoxx. We recommend starting with a prefix – such as the floor – as the doors are listed alphanumerically in the door overview.

Opening time

Select a coupling time between 6 and 12 seconds for the wAppLoxx Pro Cylinder.

Arm/disarm

Check this box to assign permissions for arming/disarming the alarm system to the cylinder. This function is only available for Intrusion cylinders and not for Access cylinders.

Reader

To use the wAppLoxx Pro to read in new tags, activate this function in the selection field. Only one wAppLoxx Pro can be defined as a reader for each wAppLoxx Pro Control Plus.

Control

Select the wAppLoxx Pro Control Plus or the previously registered slave control into which the wAppLoxx Pro cylinder is to be programmed.

Repeater

Enter the name of the repeater that was programmed before. If no repeater is provided for your master key system, you can skip this step.



If a wAppLoxx Pro Repeater or a wAppLoxx Pro Plus Slave Control should be integrated into the master key system, it must be programmed first, as associated wAppLoxx Pro components must be assigned to a slave control/repeater during programming.

Programming a wAppLoxx Pro Cylinder

1. Click "Register device"
2. Present the "system card" at the cylinder. Green flashing will indicate the start of the learning process.
3. The cylinder will now connect to the wAppLoxx Control Pro Plus or to the wAppLoxx Pro Repeater. This process may take a few seconds.
4. After successfully programming, the hardware ID of the cylinder will be displayed.

Walk test

To carry out a walk test, activate the Walk Test. You will now be prompted to turn the relevant wAppLoxx Pro cylinder knob. While you are doing so, you will be able to see the cylinder's signal strength in the software. The signal strength of a bridge box will be displayed during the walk test by pressing the cover contact button (see illustration). The walk test is used to assess the cylinder's wireless communication; special equipment is required for more precise radio measurements. The following table shows the results of the walk test.

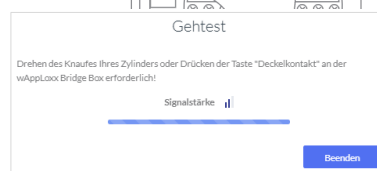
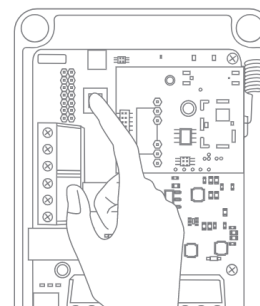

Walk test grades

No bar:	Installation not possible.
1 bar:	Weak reception that can be lost due to minor disturbances or influences. Installation is not recommended.
2 bars:	Good reception, installation can be done with little risk.
3 bars:	Strong reception, installation can be carried out with very little risk of radio failure.

Office mode

Cylinders that have Office mode activated allow the door to be opened without a tag by turning the cylinder knob. To restrict Office mode to a certain time frame, you can assign the relevant wAppLoxx Pro Cylinder to a self-defined schedule.



It should, however, be noted that Office mode cannot be activated for an Intrusion cylinder that is armed. This must first be disarmed by an authorised person.



You can find additional information on using the wAppLoxx Pro Cylinder in the separate “wAppLoxx Pro installation instructions”.



If Office mode is enabled, any locked day profiles for the set schedule will not be taken into consideration.

Programming the reset card

1. You can program the enclosed reset card under the system settings in the “System access” menu item. Click on “Program reset card”.
2. Then, present the enclosed reset card to the previously programmed cylinder.
3. Successful programming of the reset card is indicated when the cylinder flashes green and the ID card is entered in the field.
4. Click on “Save”.
5. The ID of the reset card is now transmitted to the programmed and all subsequently programmed cylinders.

7.4. wAppLoxx Pro Wall Reader or Bridge Box

The following chapter describes how to pair and unpair the Bridge Box with the wAppLoxx Pro Control Plus.

For more detailed information on connecting and starting up your wall reader, please refer to the separate operating instructions. You can access them under the following link:

<https://mobil.abus.com/Gewerbe/Zutrittskontrolle/wAppLoxx-System/Zentrale-Sets/WLX-Pro-Wall-Reader-Set-IP67-Intrusion-weiss>

Pairing the Bridge Box with the wAppLoxx Pro Control Plus

1. Click on wAppLoxx under Devices.
2. Click the green plus sign to add a Bridge Box.

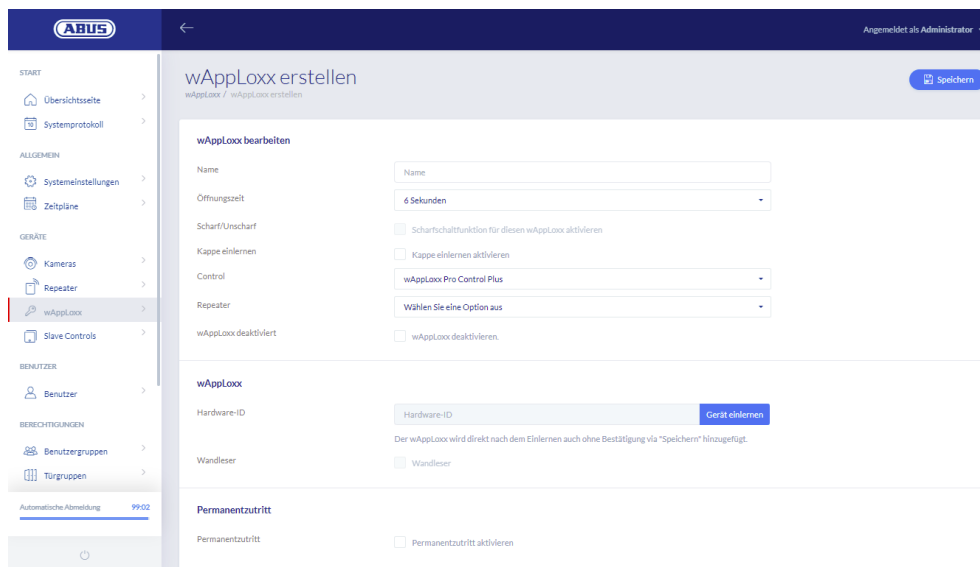

The screenshot shows the 'wAppLoxx erstellen' (Create wAppLoxx) screen in the ABUS mobile app. The interface is in German and features a sidebar menu on the left with categories like 'START', 'ALLGEMEIN', 'GERÄTE', 'BENUTZER', and 'BERECHTIGUNGEN'. The 'wAppLoxx' option under 'GERÄTE' is highlighted. The main content area is titled 'wAppLoxx bearbeiten' and contains several configuration fields: 'Name' (text input), 'Öffnungszeit' (dropdown menu set to '6 Sekunden'), 'Scharf/Uhscharf' (checkbox for 'Scharfschaltfunktion für diesen wAppLoxx aktivieren'), 'Kappe einlernen' (checkbox for 'Kappe einlernen aktivieren'), 'Control' (dropdown menu set to 'wAppLoxx Pro Control Plus'), 'Repeater' (dropdown menu with 'Wählen Sie eine Option aus'), 'wAppLoxx deaktiviert' (checkbox for 'wAppLoxx deaktivieren'), 'Hardware-ID' (text input with a 'Gerät einlernen' button), 'Wandleser' (checkbox for 'Wandleser'), and 'Permanentzutritt' (checkbox for 'Permanentzutritt aktivieren'). A 'Speichern' (Save) button is located in the top right corner.

3. Enter the name of the Wall Reader/door.
4. Select the control or repeater with which the Bridge Box is to be paired.
5. Click on "Register device", a pop-up will appear and the wAppLoxx Pro Control Plus is in pairing mode.
6. Press the green pairing button on the wAppLoxx Pro Bridge Box for at least three seconds. Once the pairing LEDs start to flash blue, release the pairing button.
7. If the pairing process is successful, the ID of the Wall Reader is displayed and the pairing LEDs light up permanently blue.
8. Finally, click on Save.

Unpairing the Bridge Box from the wAppLoxx Pro Control Plus

1. Press the pairing button on the wAppLoxx Pro Bridge Box for at least three seconds. Once the pairing LEDs start to flash blue, release the pairing button.
2. Now the pairing LEDs will start to flash red.
3. Now present the reset card or a fallback medium to the Wall Reader.
4. The Bridge Box is now unpaired from the wAppLoxx Pro Control Plus.
5. If the unpairing process was successful, only the status LED will be lit up green.

8. Setting up a master key system



Select the desired security mode before adding the Reset Card and tag.

This chapter describes the step-by-step approach to programming a Master key system in the wAppLoxx Pro Control Plus with various permissions and time profiles. The configuration process can also be performed in any order and changed at any time. At the first start-up, after programming all wAppLoxx Pro Plus slave controls and wAppLoxx Pro Repeaters (see chapter 7), proceed as follows:

1. Create doors and program Reset Card (see chapter 7.3 & 7.4)
2. Assigning doors to door groups (see chapter 8.1)
3. Create user (see chapter 8.2)
4. Assigning users and schedules to user groups (see Chapter 8.3 - 8.5)
5. Creating the locking plan (see Chapter 8.6)

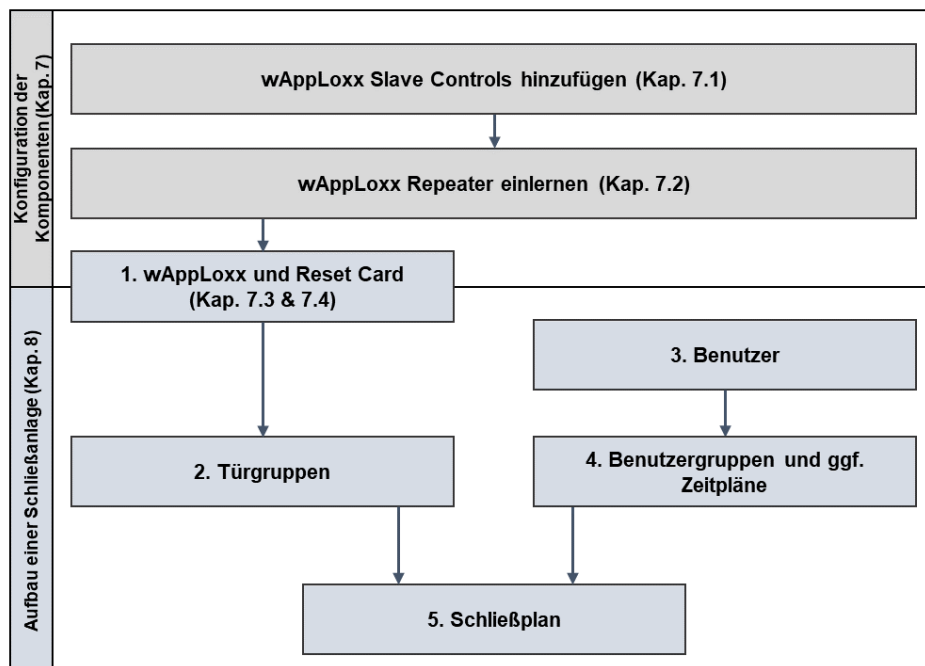

8.1. Creating door groups

To create a new door group, click on the green plus sign in the “Door groups” menu item. You can specify the following items in the “Create door group” menu:

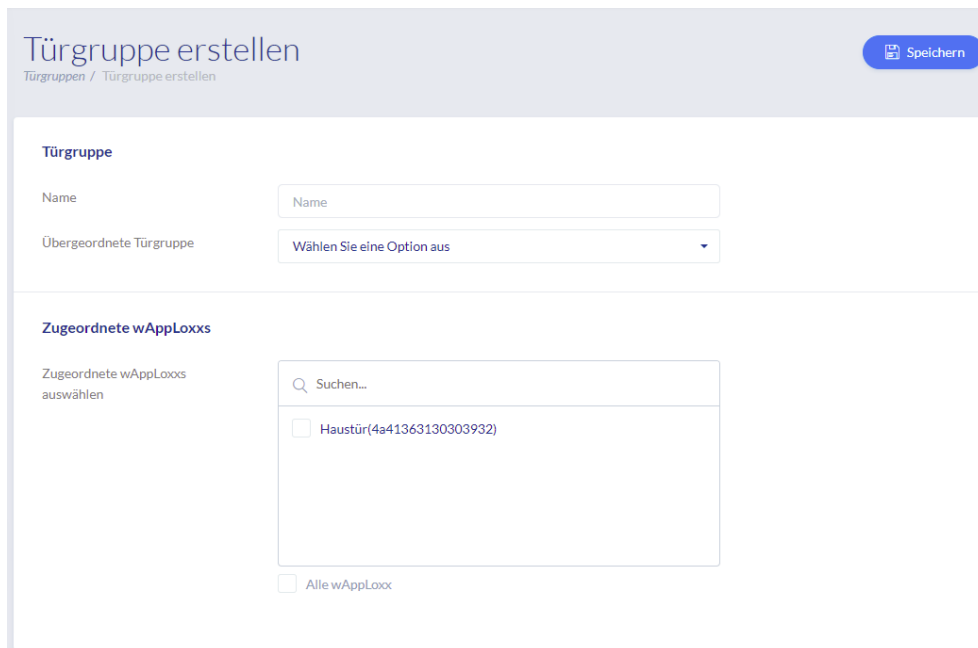

Name

Defines the name of the respective door group (e.g. "External doors" or "Construction offices")

Parent door group

The respective door group can be assigned to a superordinate door group. If you have selected "root", then the door group has no other superordinate group and is the highest within the hierarchy.

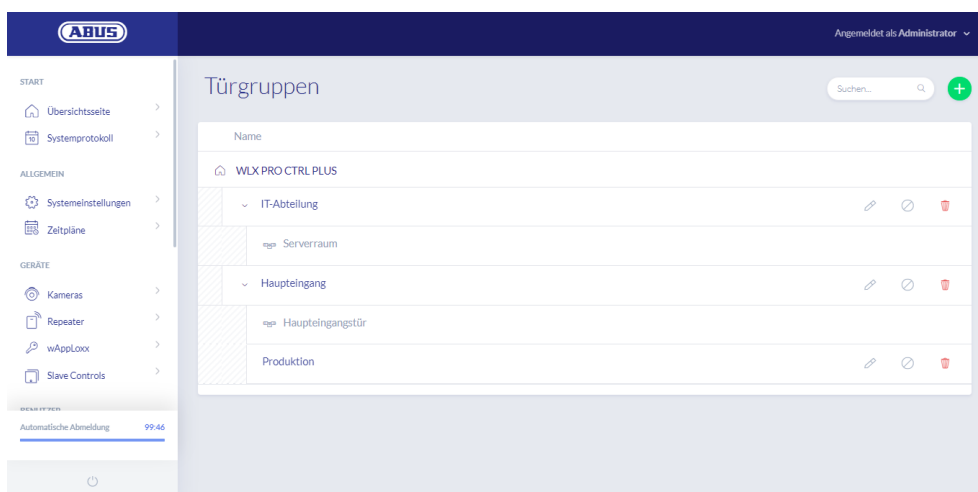

Assigned wAppLoxx

Here, you can click on the selection boxes to assign the respective doors/wAppLoxx Pro

Cylinders to the door group. Certain doors can be found more quickly through the search function. A wAppLoxx can only be assigned to one door group.

Save the settings by clicking on "Save".

In the "Door groups" menu item, you can see the hierarchical structure as well as the assignment of individual wAppLoxx Pro Cylinders to the respective door groups.

8.2. Users and tags

Create user

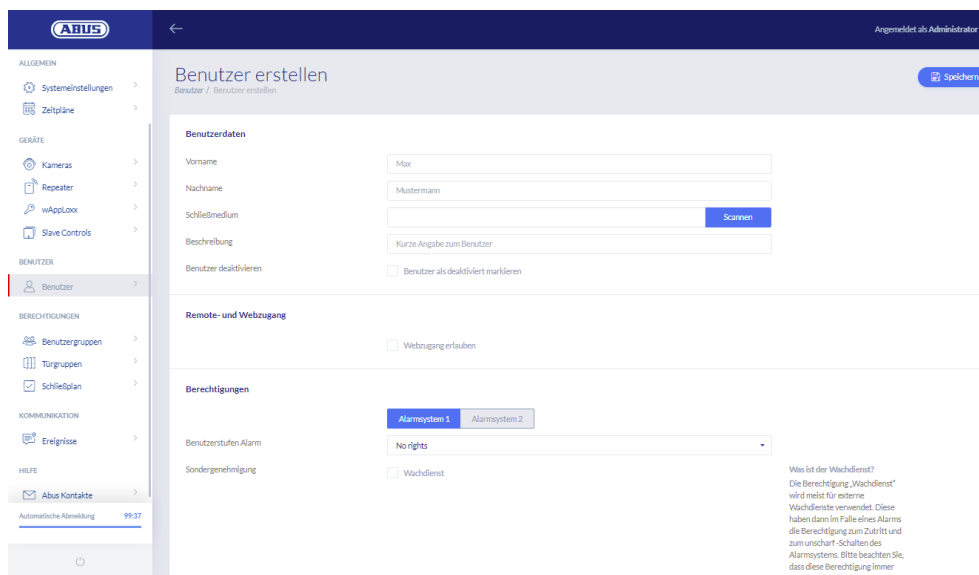

Benutzer erstellen

Benutzerdaten

Vorname: Max

Nachname: Mustermann

Schließmedium: [Scannen]

Beschreibung: Kurze Angabe zum Benutzer

Benutzer deaktivieren: Benutzer als deaktiviert markieren:

Remote- und Webzugang

Webzugang erlauben:

Berechtigungen

Alarmsystem 1 | Alarmsystem 2

Benutzerstufen Alarm: No rights

Sondergenehmigung: Wachdienst

Was ist der Wachdienst?
Die Berechtigung „Wachdienst“ wird meist für externe Wachdienste verwendet. Diese haben dann im Falle eines Alarms die Berechtigung zum Zutritt und zum unscharf-Schalten des Alarmsystems. Bitte beachten Sie, dass diese Berechtigung immer auf allen verwendet werden muss.

Enter the user's surname and given name. If the user is to be allocated a tag, click on "Register" to receive a previously unallocated tag for the wAppLoxx Pro Cylinder defined as a tag reader.

Web access

If the user is to be granted web access, select the "Allow web access" checkbox. Depending on the assigned permissions, web access allows the user to open doors remotely and/or "arm"/"disarm" security areas. Any user can delete their tag here if it has been lost. Users have the option of viewing the door protocols. This is achieved by clicking on "Enable event log". Users must log into their own user interface (see Chapter 11) to execute these functions. Users must enter a user name and password to gain access.

Remote- und Webzugang

Webzugang erlauben

Zugangsstufe: User with log

Benutzername: Mustermann

Passwort:

Passwort bestätigen:



Passwords can no longer be changed by the administrator if they have been changed by the user in the user interface. If users forget their new password, the entire user must be deleted and recreated.

After confirming the entries by clicking “Create” or “Save”, the QR code for the respective user can be displayed so that they can connect to the wAppLoxx Pro system via app (see chapter 12).

Permissions

Berechtigungen

Alarmsystem 1 | Alarmsystem 2

Benutzerstufen Alarm: Arm and disarm rights

Sondergenehmigung: Wachdienst

The Permissions area allows you to assign various rights to the user as required for the selected door groups.

Guard user

If users have access as a guard user, they can only “disarm” when the alarm is triggered and receive access permissions for all doors (door groups do not have to be assigned). These users can “arm” the system again once after establishing the cause of the alarm.



To do this, an interface to the alarm system will need to have been configured (see Chapter 10.1)

Arming/disarming

Users are authorised to “arm” and “disarm” one or both alarm systems on the doors of the selected door groups.

Arming only

Users are only authorised to “arm” one or both systems on the doors of the selected door groups.

Door groups

Select the door groups to which the users are to have access. By selecting the door group, users have access to the doors in the door group with the assigned schedule.



Without a door group, users cannot be granted any access permissions. For this reason, each user should be assigned at least one door group.

Fallback

Fallback authorisation is registered directly in the wAppLoxx Pro Cylinder and enables access when there is no wireless connection to the wAppLoxx Pro Control. This requires the tag to be presented to the wAppLoxx Pro Cylinder three times (wait for the signal each time) if the wireless connection is interrupted. It is possible to program an additional nine fallback tags for each wAppLoxx Pro Cylinder.

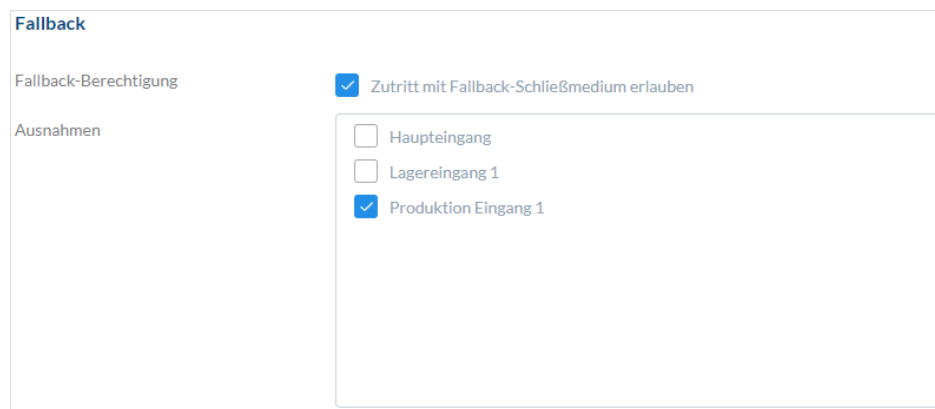

The screenshot shows a configuration window titled "Fallback". It contains two sections: "Fallback-Berechtigung" and "Ausnahmen".

- Fallback-Berechtigung:** A checkbox labeled "Zutritt mit Fallback-Schließmedium erlauben" is checked.
- Ausnahmen:** A list of three entries with checkboxes:
 - Haupteingang
 - Lagereingang 1
 - Produktion Eingang 1



If do you not wish to have a fallback function for one or several cylinders, these must be declared as exceptions. When you select the fallback authorisation, all programmed cylinders are automatically selected as fallback cylinders.



We recommend creating at least one fallback tag for each locking plan.



If a user without a tag is selected for fallback access, this user will still occupy one of the 9 possible slots for fallback tags. A tag can be subsequently assigned to the user.

 Fallback tags can be used analogously to the Reset Card to reset assigned cylinders.

Access Valid Date

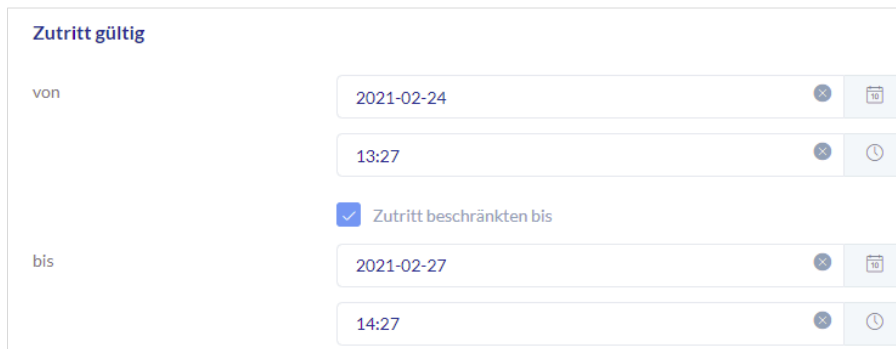

Zutritt gültig

von 2021-02-24 13:27

Zutritt beschränken bis

bis 2021-02-27 14:27

This section allows you to define an individual validity period for users. The defined validity period applies to all permissions in the system, for access to both the relevant wAppLoxx Pro Cylinder and the web.

Identify User

To identify a tag, click on “Identify” and present the tag to the wAppLoxx Pro Cylinder that is used to read tags. This now displays the user to whom the tag is assigned.

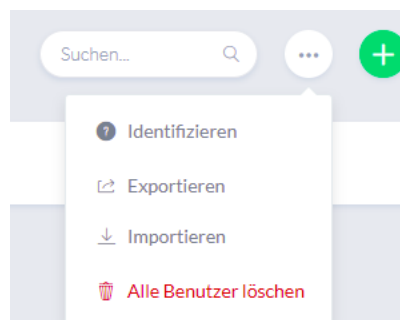

Key issue protocol

You can export a key issue log to document the issue of tags. In the user overview, click on the key to the left of the Delete icon. You can note down individual agreements and export an output protocol as a PDF file by clicking "Save and print".

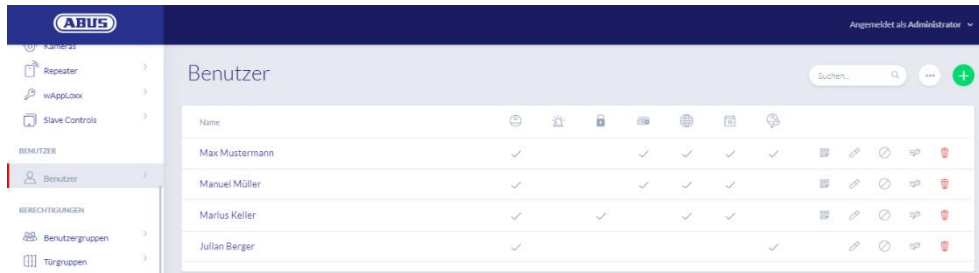

Exporting the user list

To export the user list, click on the "Export" button. The file is exported in CSV format.

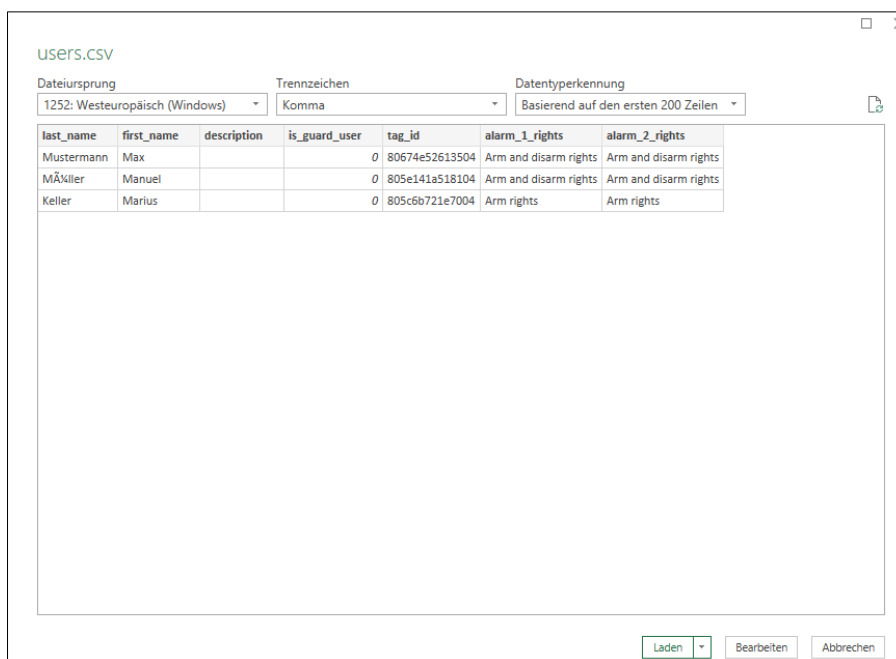

1. Open an empty workbook in MS Excel.
2. In the "Data" tab, click on "From Text/CSV".
3. Select the exported CSV file and then click "Load".



To guarantee the protection of personal data, user data for web access is not included in exports. It will need to be reassigned after importing the user list.

Import



To reimport exported user lists, click on the “Import” button. It is essential to ensure that only the exported, unformatted, original file can be used to import the users, e.g. in the event of a recovery of the wAppLoxx Pro Control Plus system.



For a successful user import, the data and column names must be created as a .csv file as shown in the example.



To guarantee the protection of personal data, user data for web access is not included in exports. It will need to be reassigned after importing the user list.

Restore settings

We recommend regularly backing up the system. You can do so via the “Export” function in the “Restore” menu. In the same menu, you can re-upload the saved data to your wAppLoxx Pro Control Plus at any time.

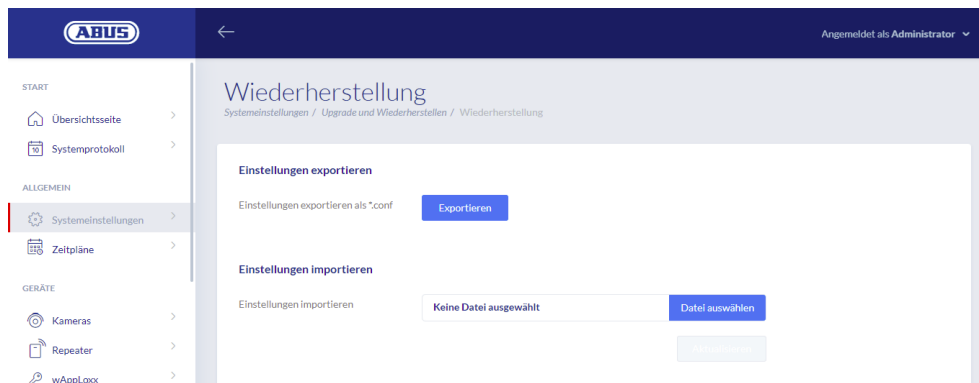

8.3. User Groups

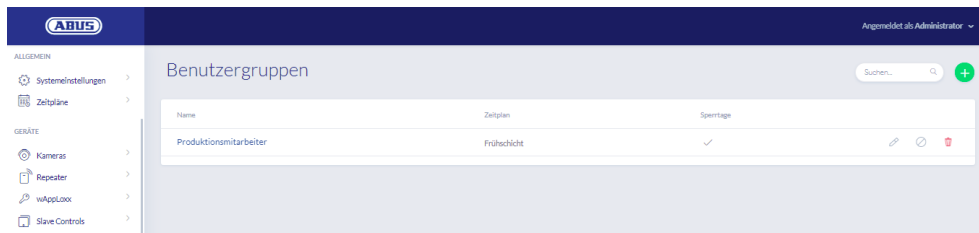

Individual users are grouped into user groups. To create a new user group, select “User groups” in the main menu and click on the green plus sign.

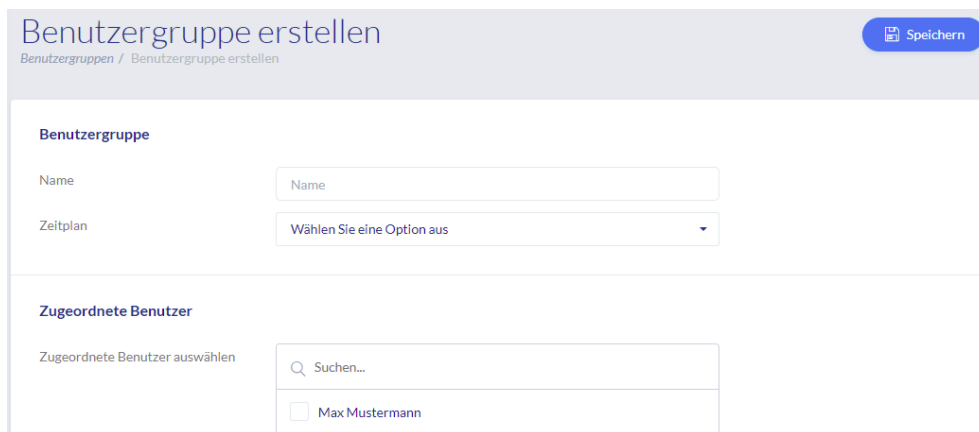

Name

Enter a name for the user group. (e.g. Management team.)

Schedule

Here you have the option to select a schedule for the user group.

Assigned Users

Here you can select the users to be assigned to this user group.

8.4. Schedules

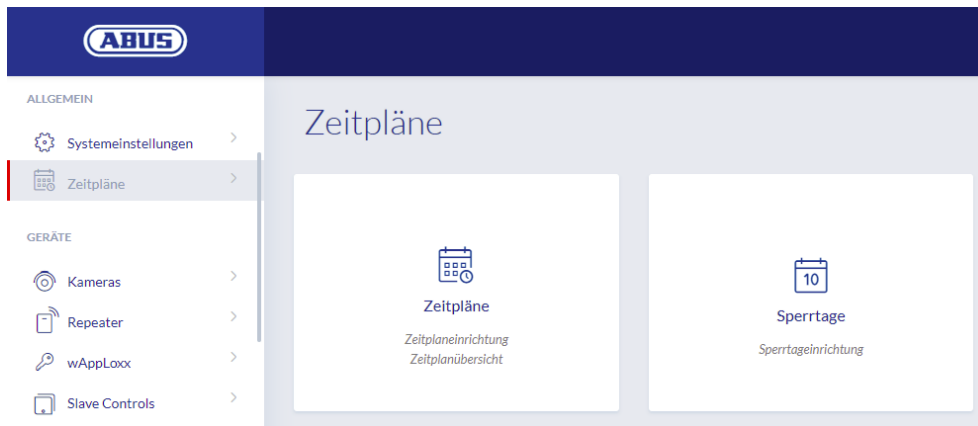

Schedules can be used to assign time-restricted access rights to certain door groups for various doors. Holiday schedules can be set up to establish different access times regardless of the day of the week (for holidays, for example).

Create schedules

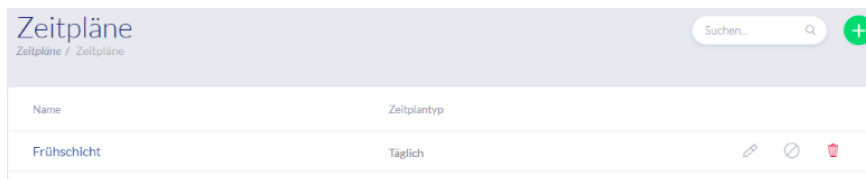

To create a schedule, select "Schedules" in the main menu.

The list contains all saved schedules that can either be edited directly or deleted. To create a new schedule, click on "Create".

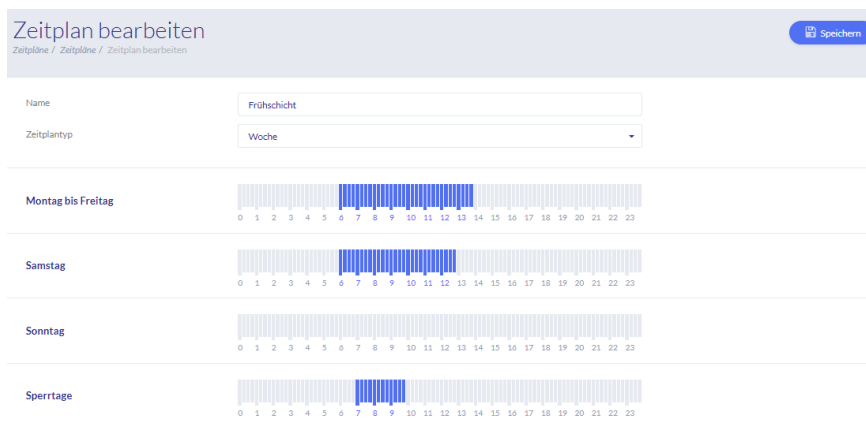

Name

Enter the name of the schedule you are creating.

Schedule Type

Here you can select from the various types of schedules.

To select access times, select the appropriate bars using the mouse (PC) or your finger (tablet/smartphone). One bar represents 15 minutes.

To apply the selection, click "Apply".



Example

The bar above "6" corresponds to the period from 06:00 to 06:15.



Example

The early shift has access from Monday to Friday between 6:00 am and 2:00 pm. On Saturdays, access is restricted to between 06:00 and 13:00. On the associated holidays, access is available between 07:00 and 10:00.

8.5. Holiday schedules

The "Holiday" menu is where you can assign various holiday schedules to the respective general schedules.

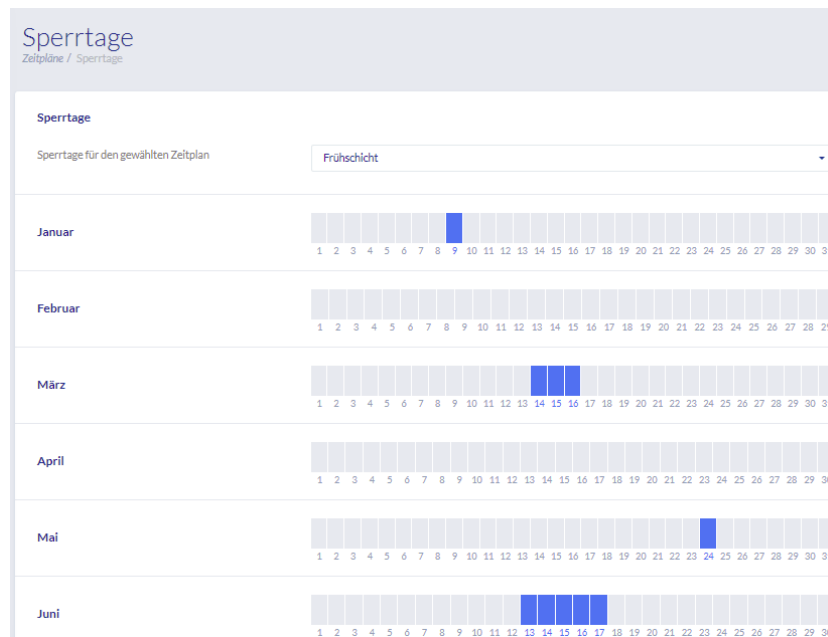

The holiday access times that have been set in the schedules are applicable on the selected holiday days.

8.6. Key lock plan

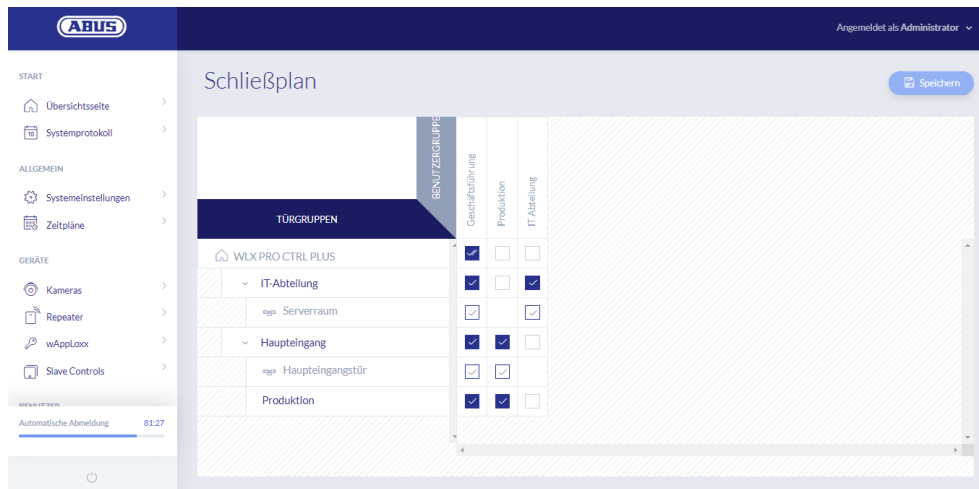

Authorisations are assigned in the wAppLoxx Pro Plus System using a locking plan matrix. The assignments and access rights are issued simply by clicking on the relevant checkbox. The following selection options appear when you click on one of the checkboxes:

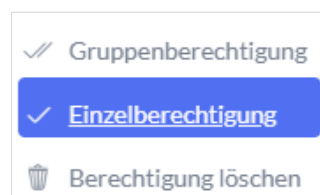

Grant general permission: Access authorisation is granted for the selected door group and its subordinate groups.

Grant single permission: Access authorisation is granted for the selected door group.

Delete permission: Access authorisation is removed from the selected door group and all subordinate groups.

Example (see above)

Double tick (group permission) by the “Management team” user group at the company’s top hierarchy level. This means that the management team has access authorisation for all doors in the company and has access authorisation for all sub-groups. A single tick by the “IT department” user group and “IT department” door group. This means that the users of the door group only have access authorisation for the “Server room” door.

9. Cameras

It is possible for video surveillance to be integrated into a wAppLoxx system.
Up to 10 ABUS IP cameras can be integrated into a wAppLoxx Pro Control Plus.

Integrating an IP camera into the wAppLoxx system

Click on “Cameras” in the administration menu to see all IP cameras already installed. If you would like to add a new IP camera, click on the green plus sign.

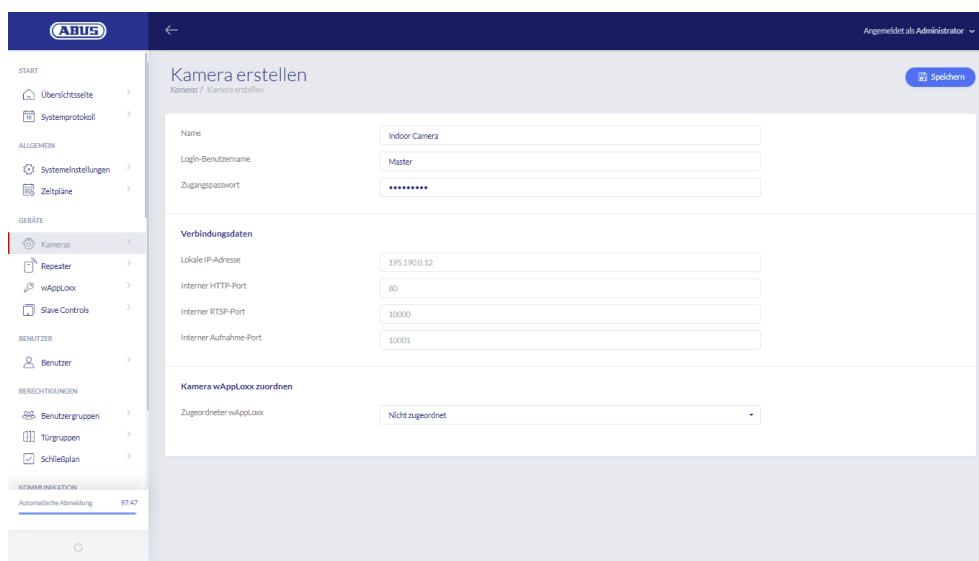

The screenshot shows the 'Kamera erstellen' (Create Camera) page in the ABUS administration interface. The page is titled 'Kamera erstellen' and 'Kamera 7 Kamera erstellen'. It features a sidebar menu on the left with options like 'START', 'ALLGEMEIN', 'GERÄTE', 'BENUTZER', 'BERECHTIGUNGEN', and 'KONTAKTANZEIGEN'. The main content area contains a form with the following fields:

- Name: Indoor Camera
- Login-Benutzername: Master
- Zugangspasswort: [masked]
- Verbindungsdaten:
 - Lokale IP-Adresse: 195.190.0.12
 - Interner HTTP-Port: 80
 - Interner RTSP-Port: 10000
 - Interner Aufnahme-Port: 10001
- Kamera wAppLoxx zuordnen:
 - Zugeordneter wAppLoxx: Nicht zugeordnet

Name

Assign a name under which your IP camera will appear in the overview of all cameras.

Login data

Enter the user name and password of your IP camera.

Connection data

Enter the IP address and ports of your ABUS IP camera. You can access this information in the ABUS IP Installer.

Assign wAppLoxx camera

You can then assign the camera to the desired wAppLoxx cylinder.



For security reasons, we recommend using the https connection mode on your camera.

10. Events

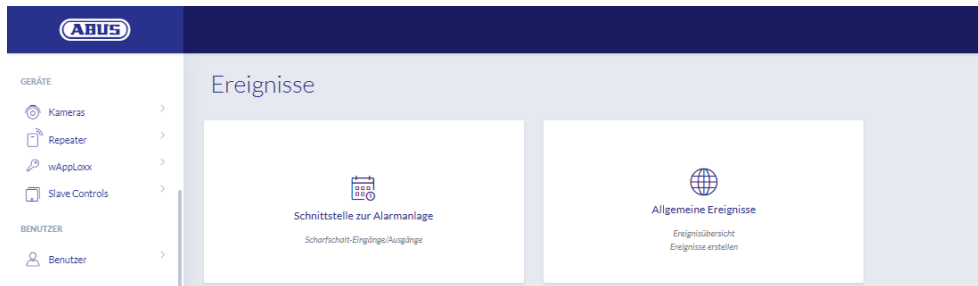

10.1. Intrusion

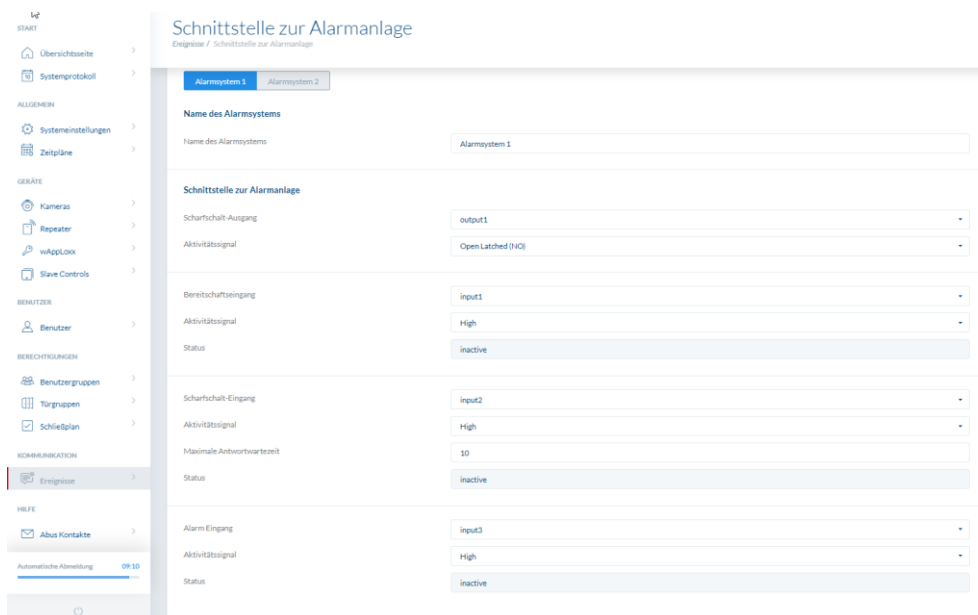

To define an interface for an alarm system, select “Events” in the main menu, then click “Intrusion”. Here you can also assign the name of the alarm system.

Arming output

You can use the arming output to arm/disarm a connected alarm system. Relay 1 is the default “arm”/“disarm” option.

Activity signal

Select between the various relay types required by the alarm panel you have connected.

- Normally open (Open Latched NO) contact: Relay closed when “armed”
- Normally closed (Closed Latched NC) contact: Relay open when “armed”
- Normally open (Open Timed NO) impulse: Relay closes for one second when “armed”

- Normally closed (Closed Timed NC) impulse: Relay opens for one second when “armed”

Ready for Arm input

The Ready for Arm option requires a signal from the burglar alarm system on the wAppLoxx Pro Control. If the alarm panel is not ready and the “Ready for arm” input is not active, the wAppLoxx Pro Control Plus prevents the system from “arming” and signals this via the wAppLoxx Pro Cylinder. Input 1 is used by default (see Chapter 3).

Activity signal

You can use the “Activity signal” option to change the input processing method.

- High: If 12 V are applied at the input, the alarm panel is ready for “arming”.
- High: If 0 V are applied at the input, the alarm panel is not ready for “arming”.
- Low: If 12 V are applied at the input, the alarm panel is not ready for “arming”.
- Low: If 0 V are applied at the input, the alarm panel is ready for “arming”.

Status

It is displayed whether this input is active.

Arm input

You can use the Arm input to “arm” and “disarm” the WAppLoxx Pro Control Plus from a connected alarm panel. Each time the connected alarm panel switches between its “armed” and “disarmed” status, the wAppLoxx Pro Control Plus is also switched between “armed” and “disarmed” accordingly. This ensures that the connected alarm panel and the wAppLoxx Pro Control Plus have the same status. Input 2 is used by default (see Chapter 3).

Activity signal

You can use the “Type” option to change the input processing method.

- High: With 12 V at the input, the wAppLoxx Pro Control Plus is "armed".
- High: With 0 V at the input, the wAppLoxx Pro Control Plus is "disarmed".
- Low: With 12 V at the input, the wAppLoxx Pro Control Plus is "disarmed".
- Low: With 0 V at the input, the wAppLoxx Pro Control Plus is "armed".

Maximum response waiting time

Select a delay time of 10 or 25 seconds. The delay time is defined by the time the alarm system on the wAppLoxx Pro Control Plus has to wait for feedback.

Status

It is displayed whether this input is active.

Alarm input

An alarm is signalled via the alarm input for the wAppLoxx Pro Control Plus. Input 3 is used by default (see Chapter 3).

Activity signal

You can use the “Activity signal” option to change the input processing method.

- High: If 12 V are applied at the input, the alarm status is active.
- High: If 0 V are applied at the input, the alarm status is not active.
- Low: If 0 V are applied at the input, the alarm status is active.
- Low: If 12 V are applied at the input, the alarm status is not active.

Status

The current status of the input is displayed.

Connection to the alarm panel

There are four options for connecting the wAppLoxx Pro Control Plus to an alarm panel:

1. Alarm system fully wired

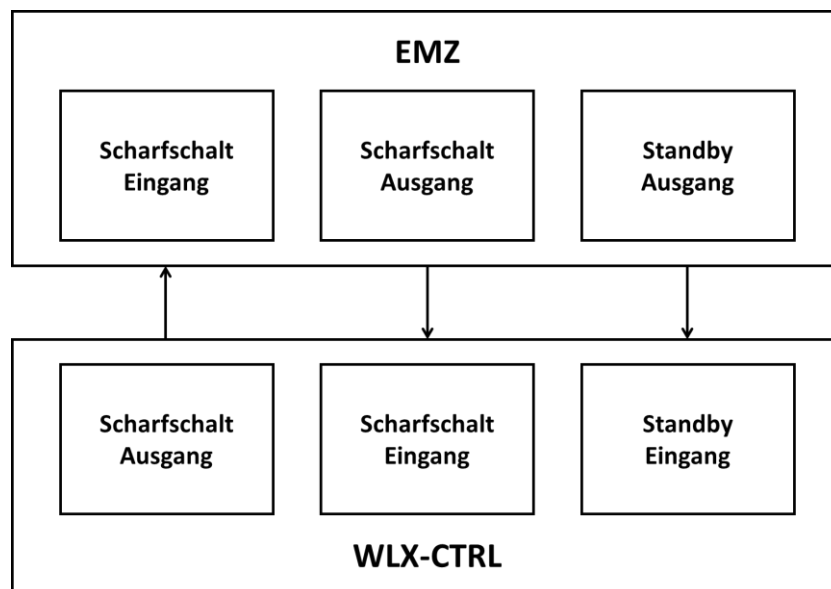

The Arm Input, Arm Output and Ready for Arm options are connected to the alarm panel. This makes it possible to “arm” and “disarm” the system using the wAppLoxx Pro Control Plus. Furthermore, the Arm command is only sent when forced action is required via the Ready for Arm input. The Arm Input has the highest priority and also operates the wAppLoxx Pro Control Plus at the same time.

2. Alarm system without Ready for Arm option (block magnet)

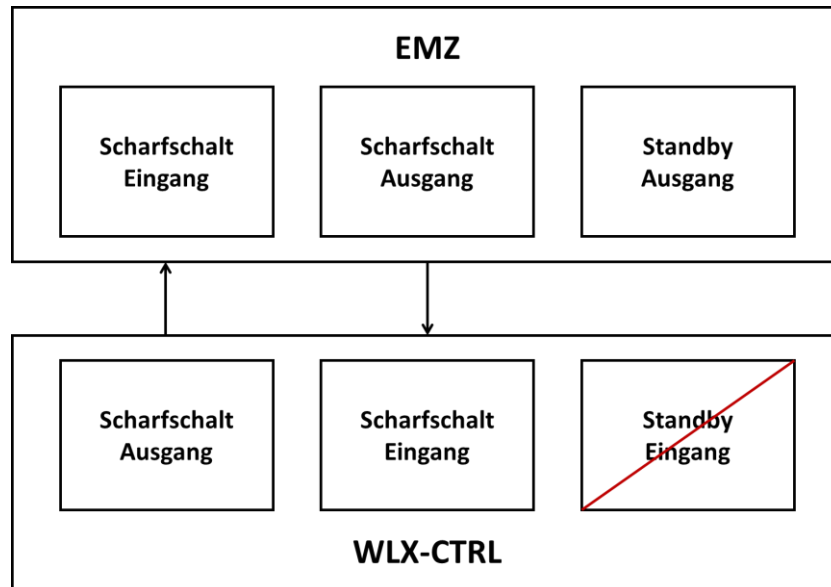

3. Dominant alarm system (locking function via alarm panel)

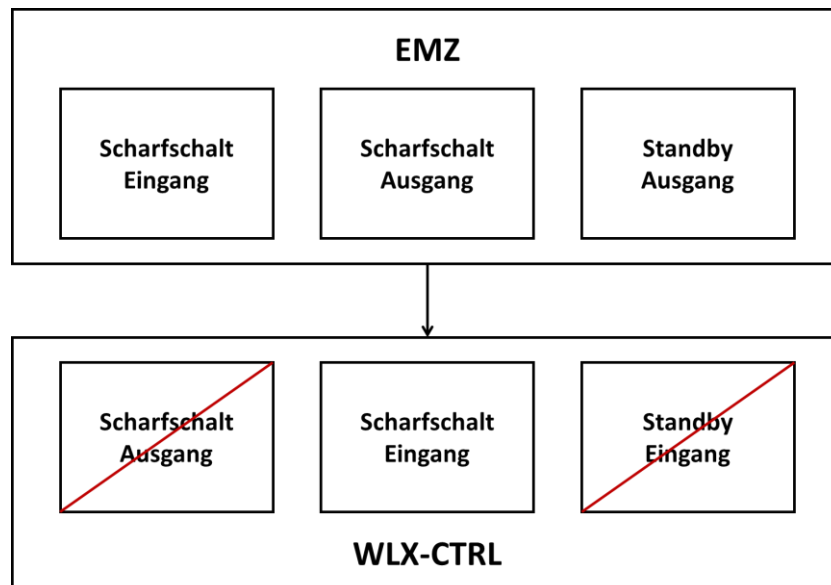

Only the Arm Input is connected to the Arm Output of the alarm panel. This involves using the alarm panel to lock the wAppLoxx Pro Control Plus in its “armed” position until the alarm panel unlocks it again. It is not possible to use the wAppLoxx Pro Control Plus to “disarm” the system here. You can only actuate the connected wAppLoxx Pro Cylinders when the alarm system is unarmed.

4. No alarm panel (locking function via wAppLoxx Pro Control Plus)

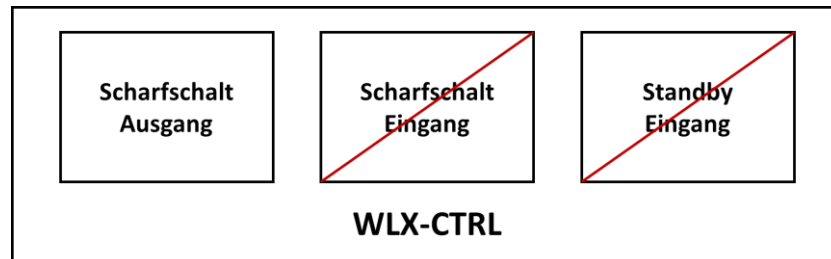

Only the Arm Output of the wAppLoxx Pro Control Plus is configured, although it is not connected. This makes it possible to lock the cylinders with an Arm command until a valid Arm/Disarm medium is presented.

10.2. Example – Secvest

The following chapter describes the connection and configuration of the Secvest with the wAppLoxx Pro Control Plus. With an alarm area, the wAppLoxx Pro Control Plus can be connected directly to the Secvest. If two alarm areas are required, the Secvest Hybrid Module is connected.

10.2.1. One alarm area

On the wAppLoxx Pro Control Plus, Input 1 is used for arming preparation and Input 2 for arming acknowledgement. Thus, output 1 of the wAppLoxx Pro Control Plus controls the zone input 1 on the Secvest for arming.

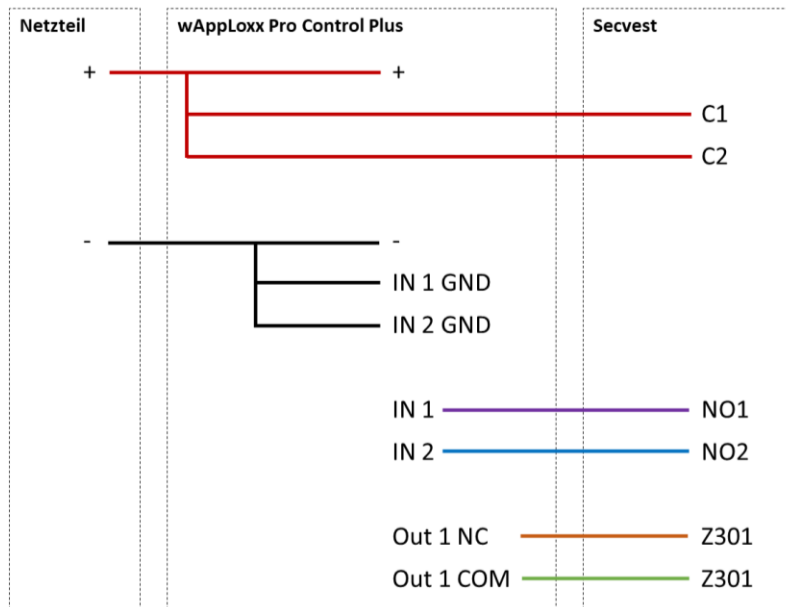
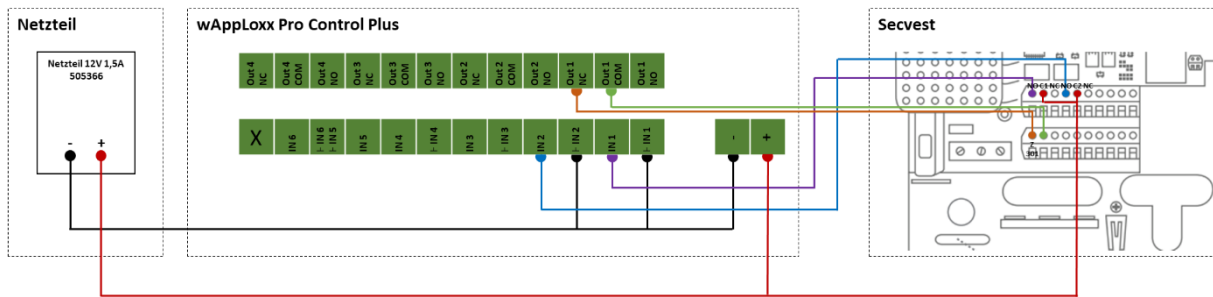

Configuration of the wAppLoxx Pro Control Plus to the Secvest alarm panel interface

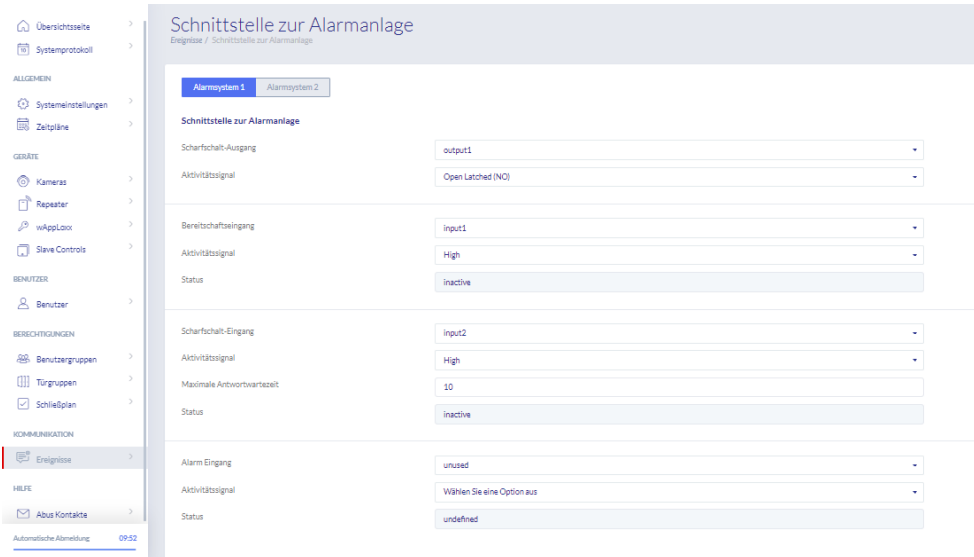

The screenshot displays the 'Schnittstelle zur Alarmanlage' (Alarm Panel Interface) configuration page. The left sidebar contains a navigation menu with categories: ÜBERSICHTSEITE, SYSTEMPROTOKOLL, ALLGEMEIN, GERÄTE, BENUTZER, BERECHTIGUNGEN, KOMMUNIKATION, and HILFE. The main content area is titled 'Schnittstelle zur Alarmanlage' and includes a breadcrumb 'Eingänge / Schnittstelle zur Alarmanlage'. Two tabs are visible: 'Alarmsystem 1' (selected) and 'Alarmsystem 2'. The configuration is organized into three sections, each with a 'Scharfschalt-Eingang' (Armed Entry) and 'Aktivitätssignal' (Activity Signal) field. The 'Status' field for each section is currently set to 'inactive'. The 'Maximale Antwortverzögerung' (Maximum Response Delay) is set to '10'. The 'Alarm Eingang' (Alarm Entry) is set to 'unused', and the 'Aktivitätssignal' is set to 'Wählen Sie eine Option aus' (Select an option).

Section	Scharfschalt-Eingang	Aktivitätssignal	Status	Maximale Antwortverzögerung
Alarmsystem 1	output1	Open Latched (NO)	inactive	
Alarmsystem 1	input1	High	inactive	
Alarmsystem 1	input2	High	inactive	10
Alarmsystem 1	unused	Wählen Sie eine Option aus	undefined	



Configuration of wired zone 301 as key switch duration on the Secvest

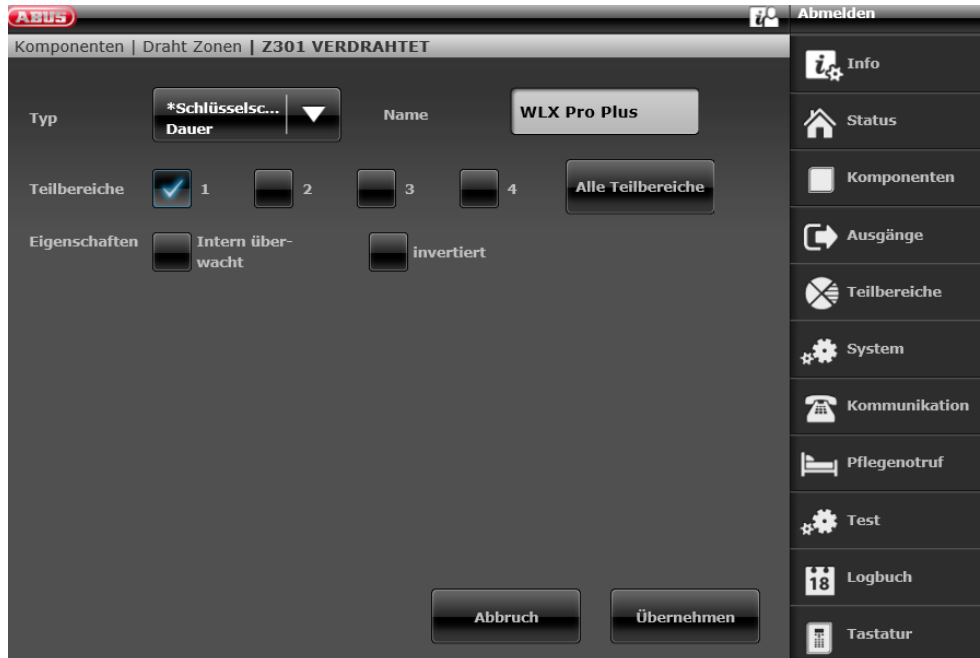

Configuration of the wired output 301 (relay 01) for the ready signal on the Secvest



Configuration of the wired output 302 (relay 02) for the activation on the Secvest



Configuration of the output mode for each partition on the Secvest (not pre-configured)

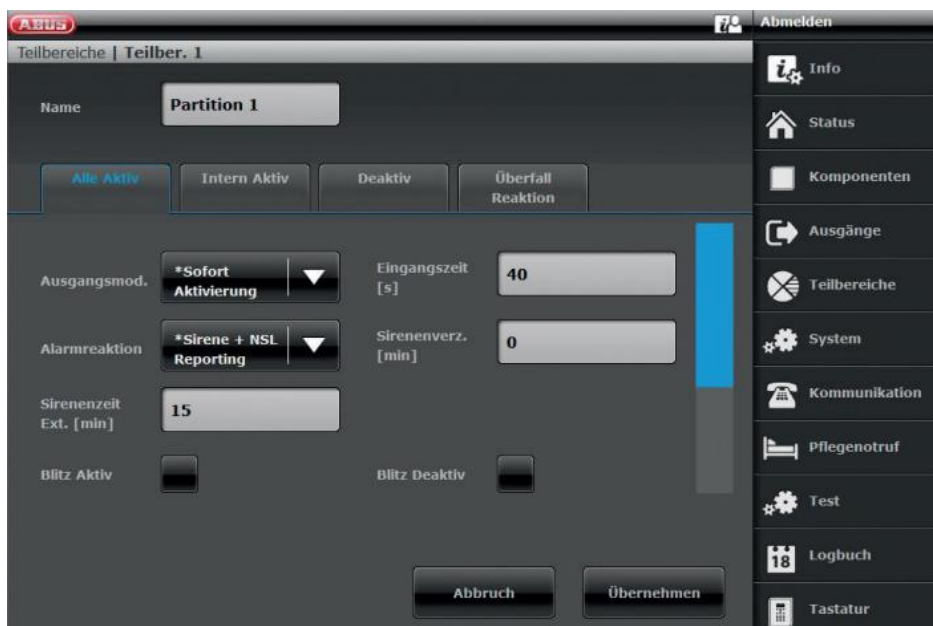

10.2.2. Two alarm areas

In addition to wiring with an alarm area, the wAppLoxx Pro Control Plus uses input 4 for arming preparation and input 5 for arming acknowledgement. In addition, output 2 of the wAppLoxx Pro Control Plus controls zone input 2 on the Secvest for arming.

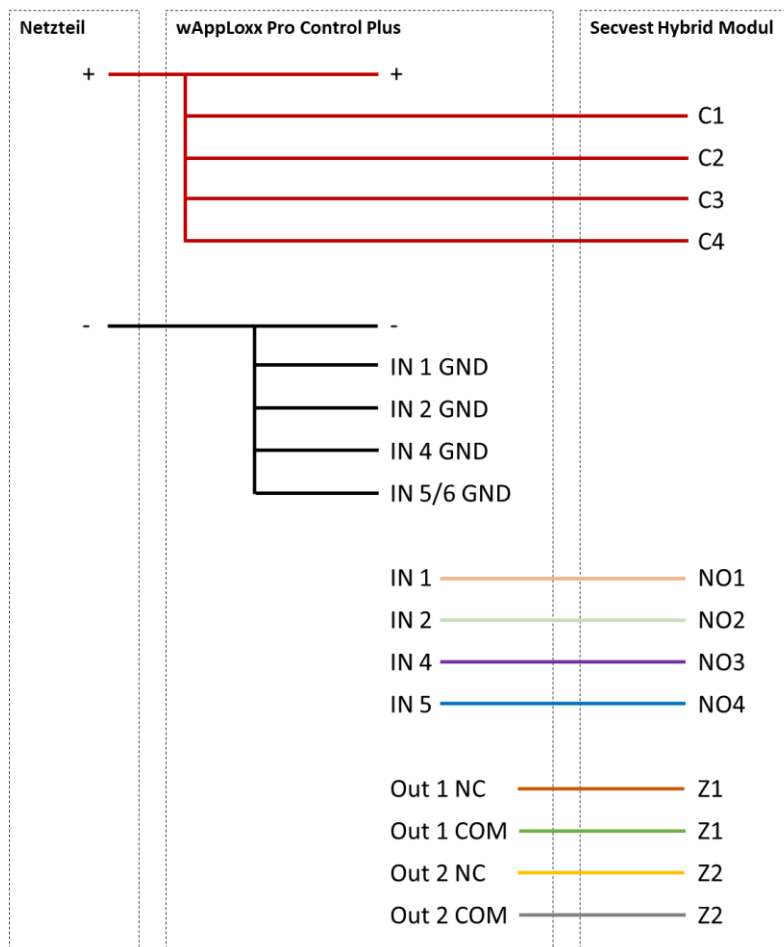
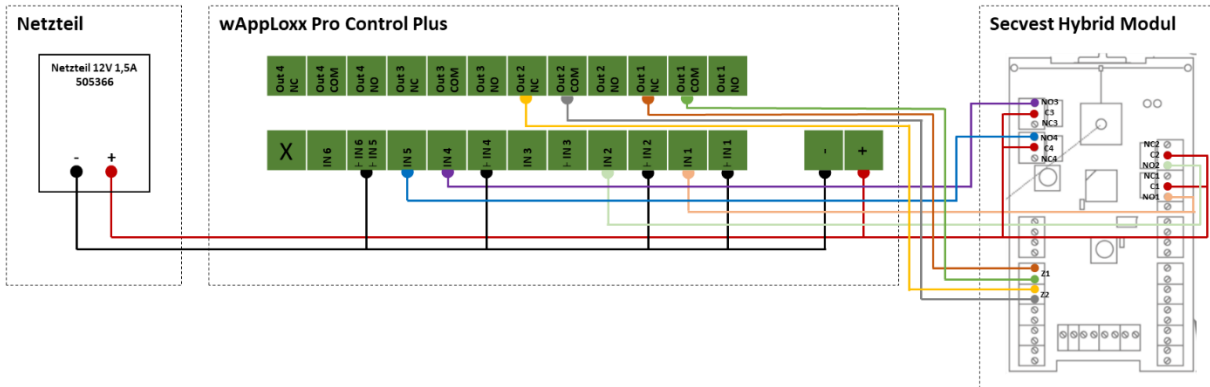

Configuration of the wAppLoxx Pro Control Plus to the Secvest alarm panel interface

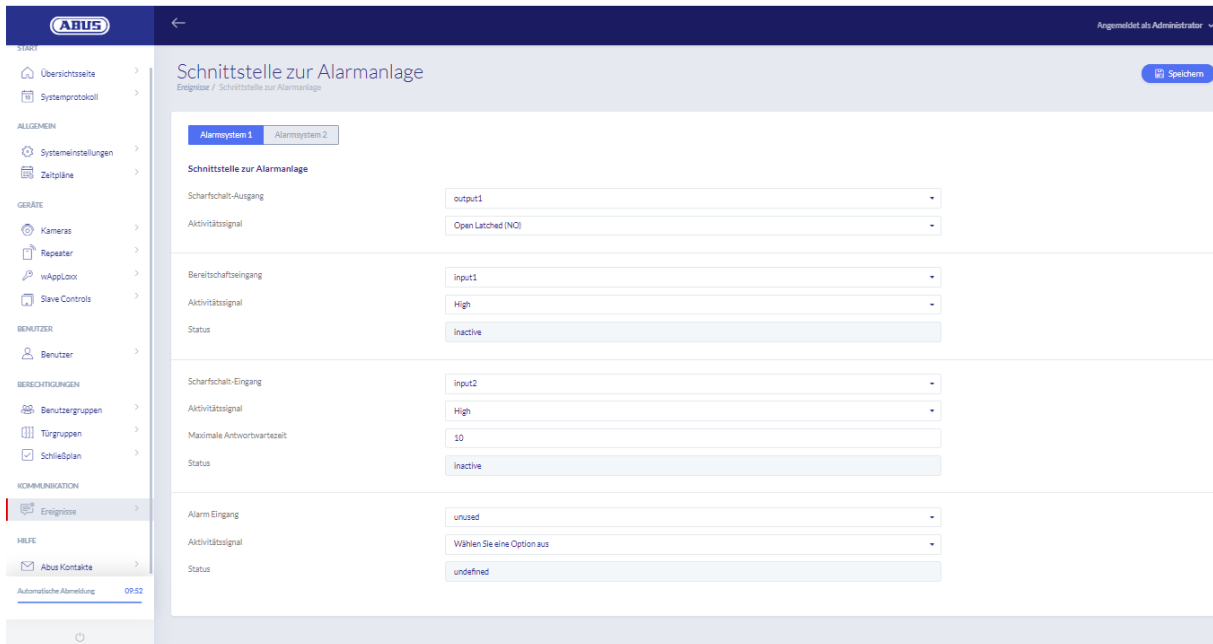

The screenshot shows the 'Schnittstelle zur Alarmanlage' configuration page for 'Alarm System 1'. The left sidebar contains navigation options like 'Übersichtsseite', 'Systemprotokoll', 'Systemeinstellungen', 'Zeitchläne', 'Geräte', 'Kameras', 'Repeater', 'wAppLoxx', 'Slave Controls', 'Benutzer', 'Benutzergruppen', 'Türgruppen', 'Schließplan', 'Ereignisse', and 'Abus Kontakte'. The main content area is titled 'Schnittstelle zur Alarmanlage' and includes a 'Speichern' button. The configuration is organized into sections: 'Alarm System 1', 'Schnittstelle zur Alarmanlage', 'Scharfschalt-Ausgang', 'Aktivitätssignal', 'Bereitschaftseingang', 'Aktivitätssignal', 'Status', 'Scharfschalt-Eingang', 'Aktivitätssignal', 'Maximale Antwortzeit', 'Status', 'Alarm Eingang', 'Aktivitätssignal', and 'Status'. The values for these fields are: Scharfschalt-Ausgang: output1; Aktivitätssignal: Open Latched (NO); Bereitschaftseingang: input1; Aktivitätssignal: High; Status: inactive; Scharfschalt-Eingang: input2; Aktivitätssignal: High; Maximale Antwortzeit: 10; Status: inactive; Alarm Eingang: unused; Aktivitätssignal: Wählen Sie eine Option aus; Status: undefiniert.

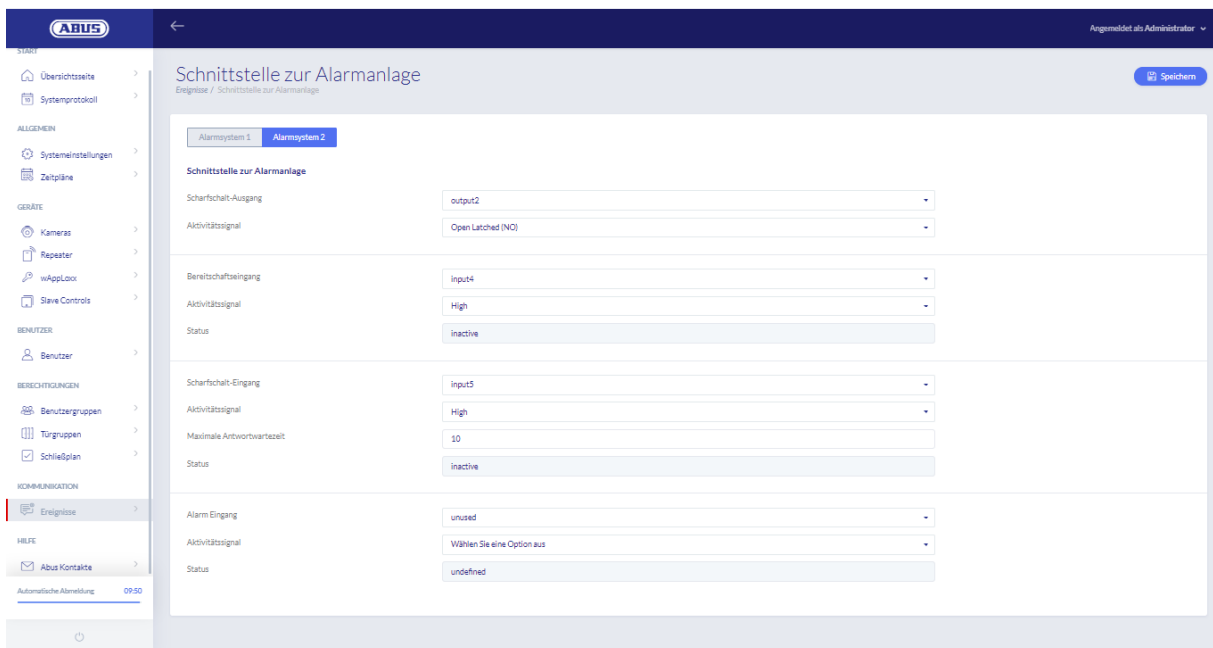

The screenshot shows the 'Schnittstelle zur Alarmanlage' configuration page for 'Alarm System 2'. The left sidebar is identical to the first screenshot. The main content area is titled 'Schnittstelle zur Alarmanlage' and includes a 'Speichern' button. The configuration is organized into sections: 'Alarm System 2', 'Schnittstelle zur Alarmanlage', 'Scharfschalt-Ausgang', 'Aktivitätssignal', 'Bereitschaftseingang', 'Aktivitätssignal', 'Status', 'Scharfschalt-Eingang', 'Aktivitätssignal', 'Maximale Antwortzeit', 'Status', 'Alarm Eingang', 'Aktivitätssignal', and 'Status'. The values for these fields are: Scharfschalt-Ausgang: output2; Aktivitätssignal: Open Latched (NO); Bereitschaftseingang: input4; Aktivitätssignal: High; Status: inactive; Scharfschalt-Eingang: input5; Aktivitätssignal: High; Maximale Antwortzeit: 10; Status: inactive; Alarm Eingang: unused; Aktivitätssignal: Wählen Sie eine Option aus; Status: undefiniert.

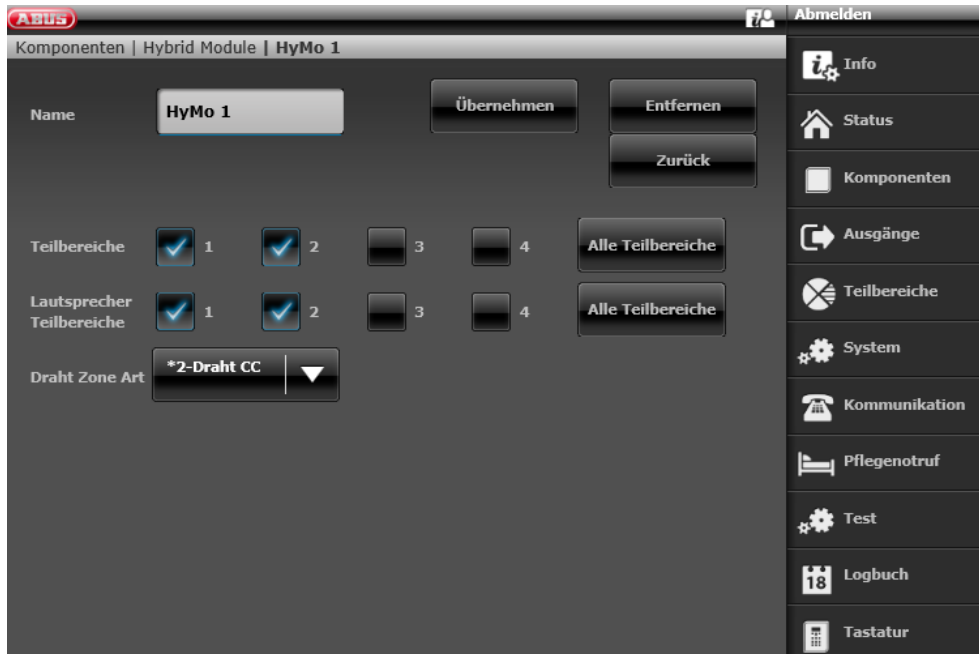

Configuration of HyMo Zone 401 as key switch duration on the Secvest

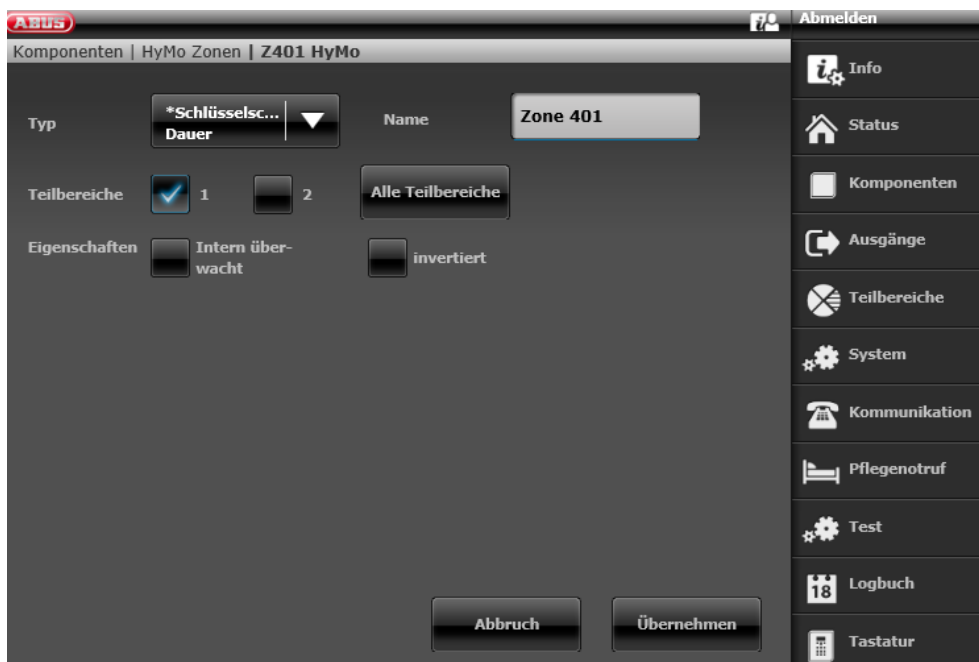

Configuration of HyMo Zone 402 as key switch duration on the Secvest

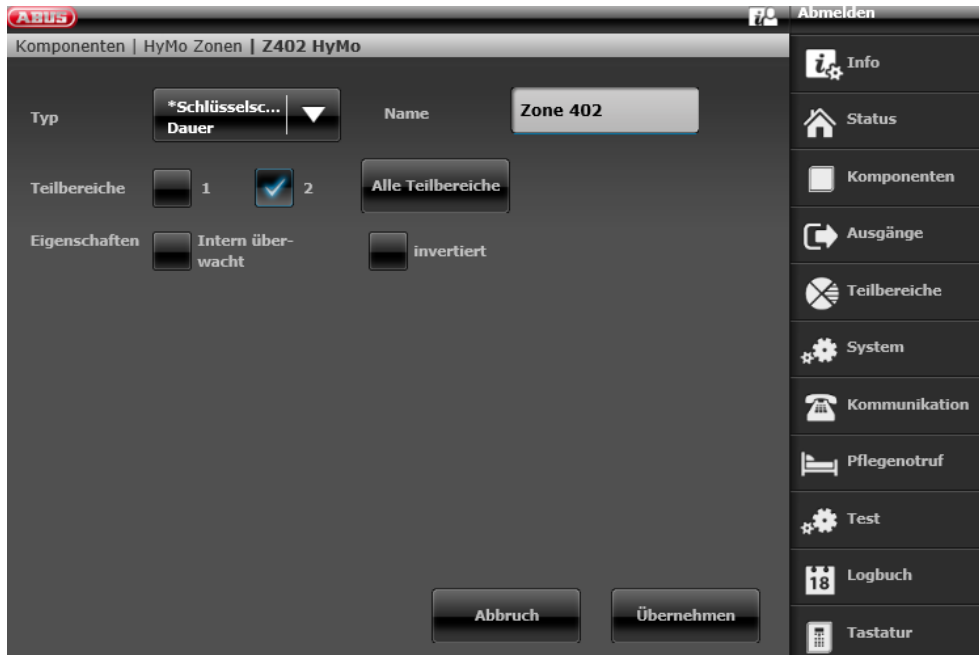

Configuration of HyMo output 401 (relay 01) for the ready signal on the Secvest



Configuration of HyMo output 402 (relay 02) for activation on the Secvest

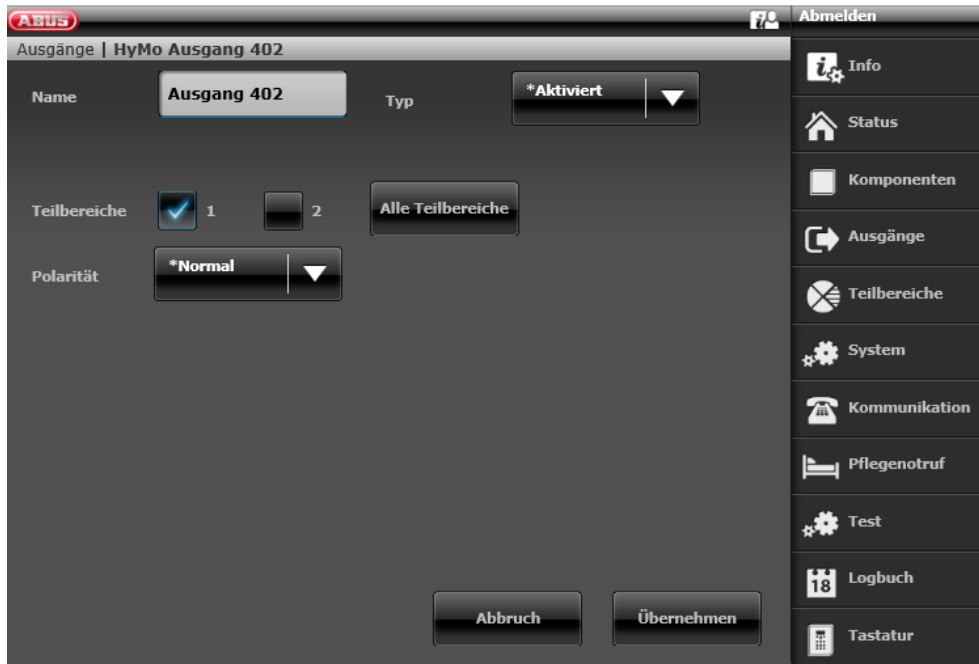

Configuration of HyMo output 403 (relay 03) for the ready signal on the Secvest

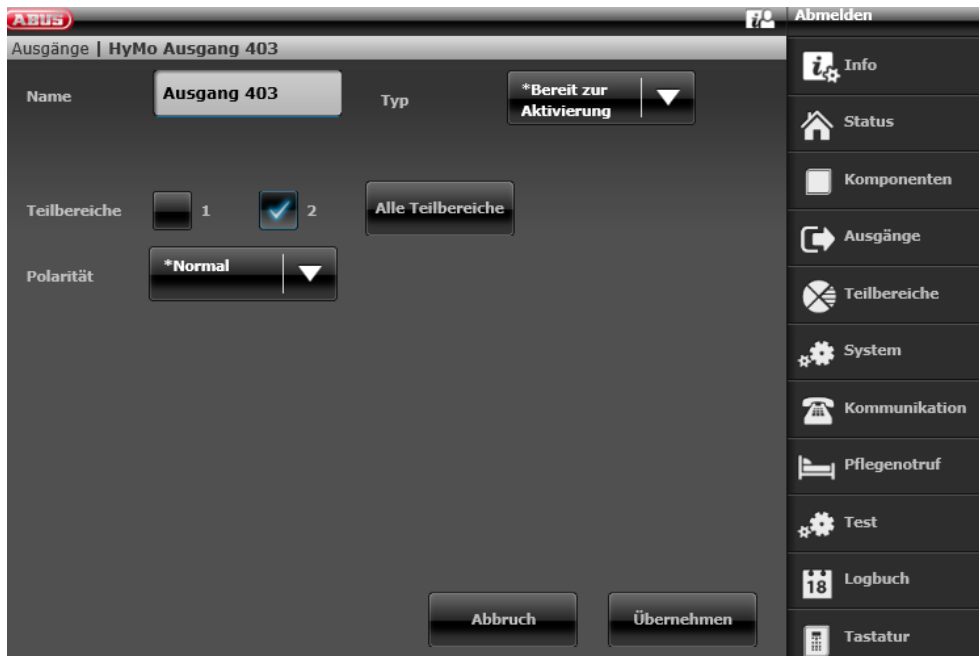

Configuration of HyMo output 404 (relay 04) for activation on the Secvest

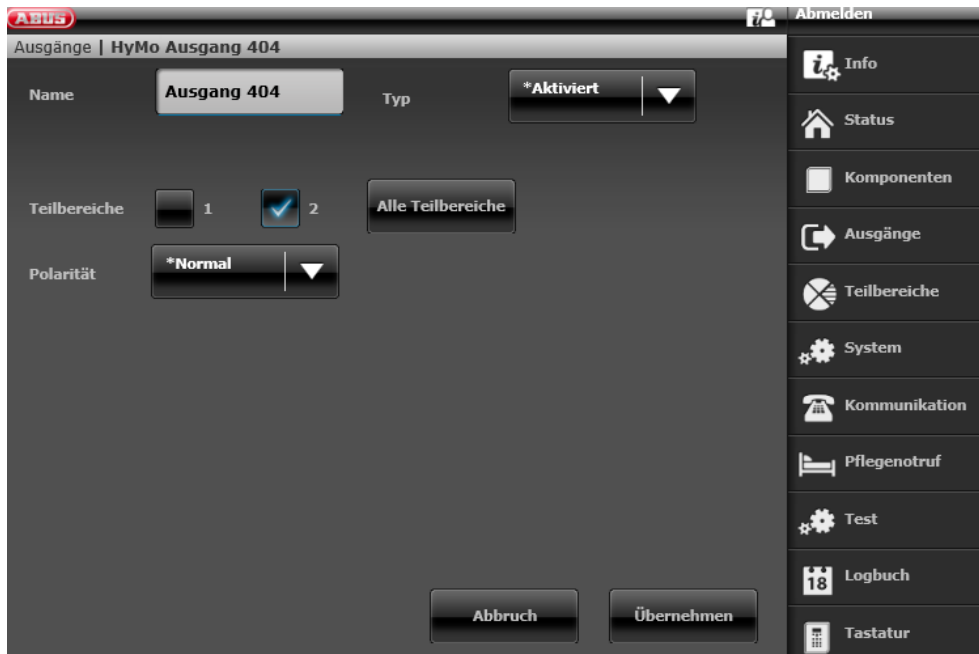

Configuration of the output mode for partition 1 on the Secvest (not pre-configured)

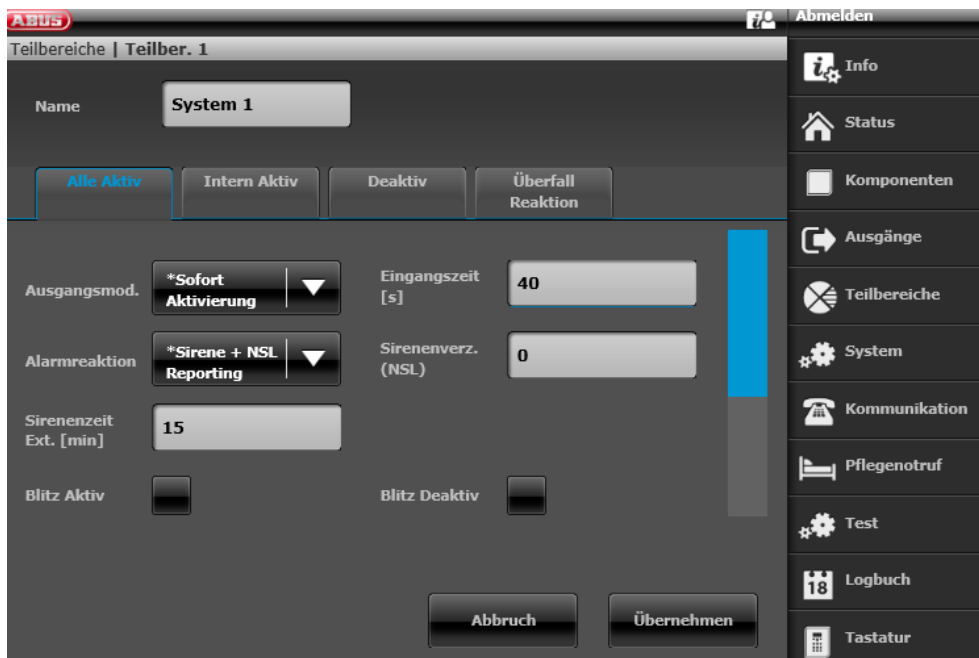

Configuration of the output mode for partition 2 on the Secvest (not pre-configured)

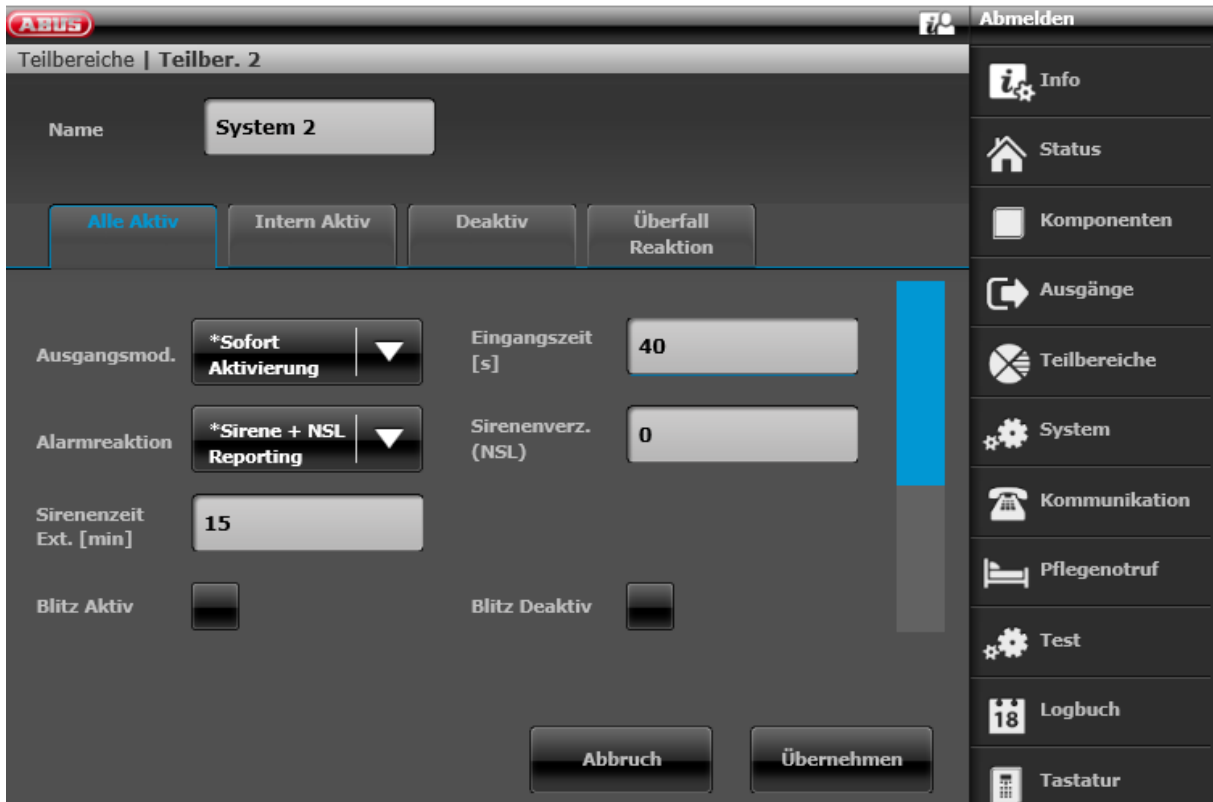

The screenshot displays the configuration interface for 'System 2' in the ABUS Security Center. The interface is dark-themed with a sidebar on the right containing navigation options: Abmelden, Info, Status, Komponenten, Ausgänge, Teilbereiche, System, Kommunikation, Pflegenotruf, Test, Logbuch, and Tastatur. The main configuration area includes:

- Name:** System 2
- Mode Selection:** Four buttons: Alle Aktiv (highlighted in blue), Intern Aktiv, Deaktiv, and Überfall Reaktion.
- Ausgangsmod.:** A dropdown menu set to '*Sofort Aktivierung'.
- Alarmreaktion:** A dropdown menu set to '*Sirene + NSL Reporting'.
- Eingangszeit [s]:** A text input field containing '40'.
- Sirenenverz. (NSL):** A text input field containing '0'.
- Sirenenzeit Ext. [min]:** A text input field containing '15'.
- Blitz Aktiv:** A checkbox that is currently unchecked.
- Blitz Deaktiv:** A checkbox that is currently unchecked.
- Buttons:** 'Abbruch' and 'Übernehmen' buttons at the bottom.

10.3. Example FaceXess

The FaceXess terminal can be used in conjunction with the wAppLoxx Pro Control Plus. This allows wAppLoxx Pro Cylinders to be unlocked in response to persons recognised at the FaceXess terminal.

To do this, the relay output of the Secure Module is wired to one of the inputs of the Control. The desired cylinder is then configured to be released in response to the impulse. The release time can be selected from several options (e.g. 5 s, 15 s or 30 s).

The FaceXess terminal can also be connected directly to the Control, but this is only recommended for indoor use.

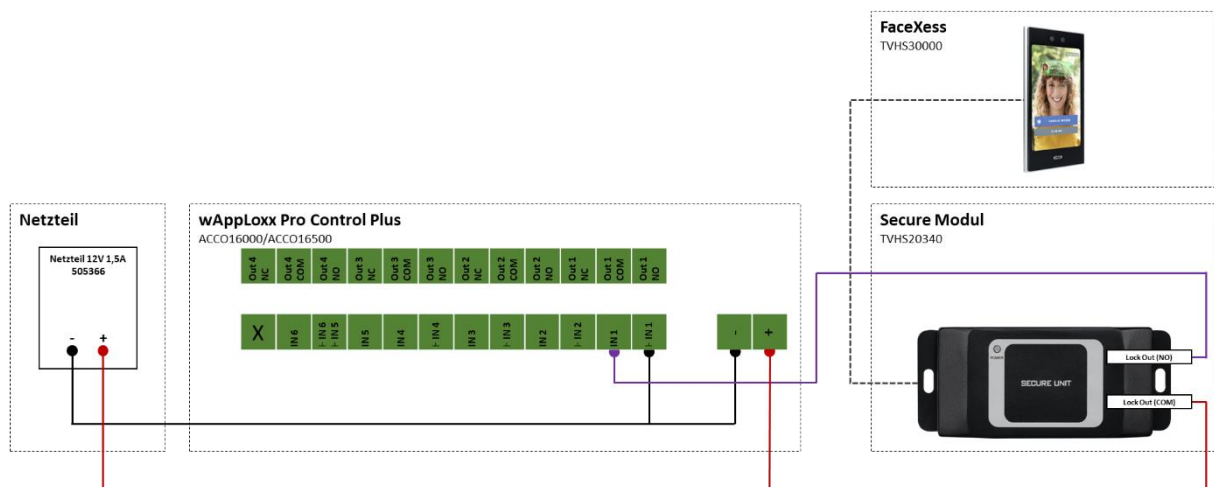

Allgemeines Ereignis bearbeiten Speichern

Ereignisse / Allgemeine Ereignisse / Allgemeines Ereignis bearbeiten

Ereignis

Name:

Ereignisquelle

Quelle:

Verbindungsstück:

Aktivitätssignal:

Status:

Ereignisreaktionen +

Reaktionstyp	<input type="text" value="wAppLoxx freigeben"/>	<input type="text" value=""/>
wAppLoxx	<input type="text" value="Haupteingang(JA610071)"/>	<input type="text" value=""/>
Dauer in Sekunden	<input type="text" value="5 Sekunden"/>	<input type="text" value=""/>

Combination with an alarm system is also possible. It is recommended to use a wAppLoxx Pro Intrusion Cylinder. Assign the cylinder to the alarm area to ensure inevitability. When the alarm system is armed, access via the FaceXess Terminal is blocked by releasing the cylinder. This prevents false alarms.

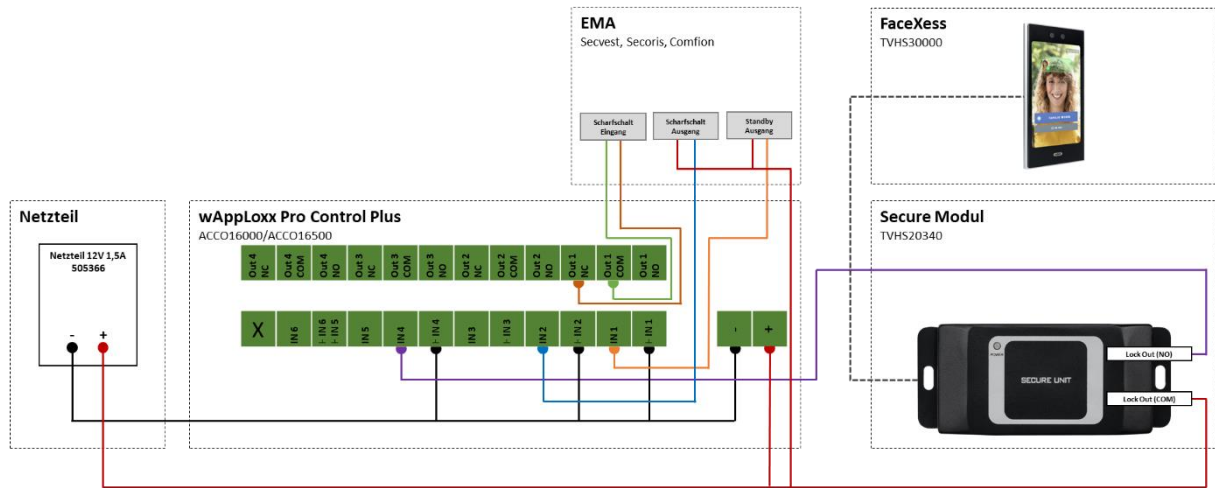

Event for releasing the cylinder when a person is recognised

Algemeines Ereignis bearbeiten

Ereignis bearbeiten

Name: FaceXess - wAppLoxx freigegeben

Ereignisquelle

Quelle: External Input

Verbindungsstück: Input4

Aktivitätssignal: Impulse

Status: Low

Ereignisreaktionen

Reaktionstyp: wAppLoxx freigegeben

wAppLoxx: Haupteingang (IA610071)

Dauer in Sekunden: 5 Sekunden

Speichern

Assignment of intrusion cylinder to alarm area

ABUS

Logged in as Administrator

ALLGEMEIN

- Systemeinstellungen
- Zeitpläne

GERÄTE

- Kameras
- Repeater
- wAppLoxx
- Slave Controls

BEWÜTZER

wAppLoxx bearbeiten

Name: Haupteingang

Öffnungszeit: 5 Sekunden

Scharf/Unscharf: Scharf/Scharf Funktion für diesen wAppLoxx aktivieren

Zuordnung: Produktion

Leser: Diesen wAppLoxx zum Einlernen von Schließmedien verwenden

Speichern

10.4. General events

To create an event, select “General events” in the main menu, then click on “Create Event”.

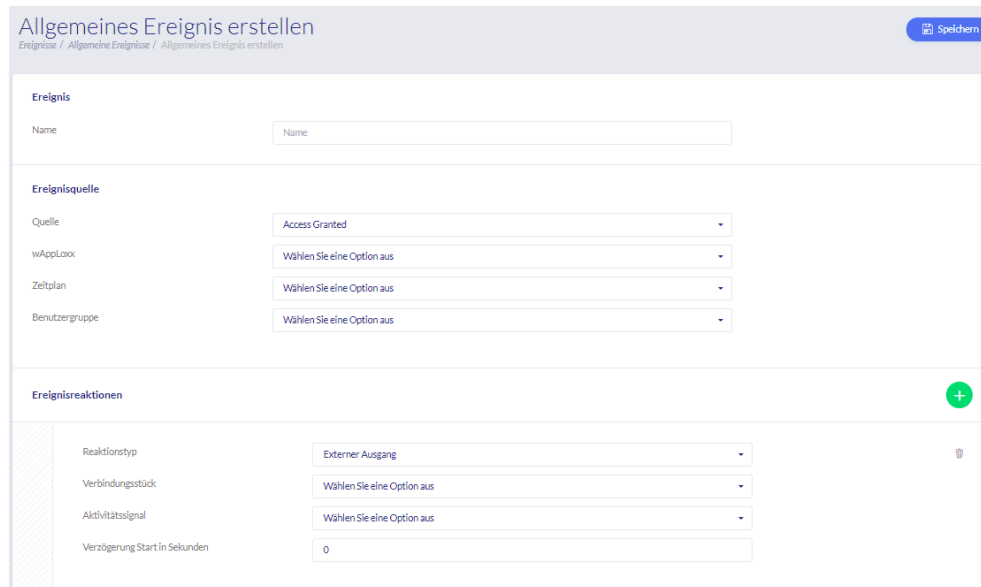

An event always comprises an action and a reaction. Enter a name for the event and select an event source that should be followed by a reaction. You can select up to 4 different reactions per event source.

Event sources

Access granted	Action starts as soon as access is granted.
Access denied	Action starts as soon as access is denied. Access blocked and access outside the permitted time frame.
Arm	Action starts as soon as the alarm system has been successfully “armed”.
Disarm	Action starts as soon as the alarm system has been successfully “disarmed”.
Tag unknown	Action starts as soon as an unknown tag is presented at a selected door. Only the tags that function with the set mode are recorded.
Tamper	Action starts as soon as the tamper contact has been interrupted.
Repeater tamper	Action starts as soon as the cover tamper contact for the repeater is triggered.

Power supply repeater disconnected	Action starts as soon as the repeater has been disconnected from the power supply.
Repeater back on power supply	Action starts as soon as the repeater is reconnected to the power supply.
Battery warning	Action starts as soon as the selected wAppLoxx Pro Cylinder displays a battery warning.
Battery Count Warning	Action starts as soon as the selected wAppLoxx Pro Cylinder has reached the maximum number of switching cycles. This is a battery warning which is sent when the maximum guaranteed number of openings per wAppLoxx Pro Cylinder is reached.
External Input	Action starts as soon as the input is active.
Alarm input	Action starts as soon as the alarm input is active and an alarm has been triggered.
Signal loss	Action starts as soon as a cylinder does not respond during supervision (every 24 hours).
Internet disconnected	Action starts as soon as there is no longer an internet connection to the Control.
Hotkey	Select which hot key you want to use for which door group.

Event reactions

Email notification	Select the email recipient you would like to inform about a defined event.
External output	If, after an action, a relay is to be triggered as a reaction, select the relay (for relay connections, see Chapter 3). You can then select the activity signal and the delay in seconds.
wAppLoxx	Select a cylinder to be coupled as an event response.
Camera	Here you can select the desired reaction (either video recording or snapshot) when arming a camera.

Please note that the following two settings must be deactivated in the camera for the recording of event-controlled snapshots/recordings:

- Sequential single image recording
- Event-controlled single image recording

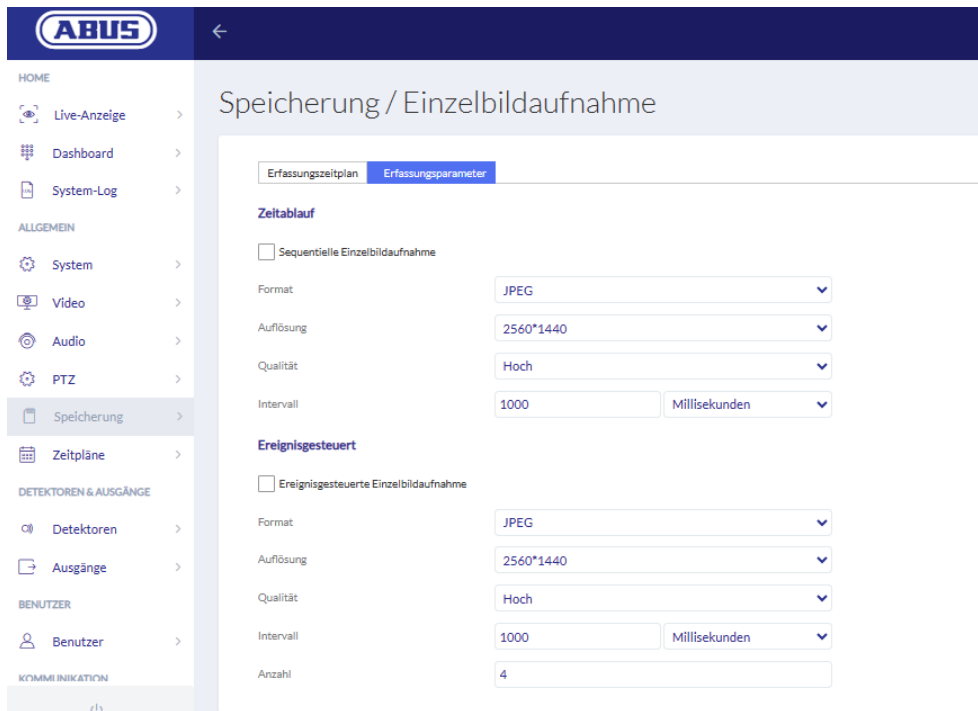

Settings of the ABUS Camera

An event for "external input" must always be programmed with a reaction with "enable wAppLoxx", "external output" or "camera" so that an e-mail notification is sent.

11. User Login

To access the user level, please enter the user data. User data is created in the administrator user menu (see Chapter 8.2).

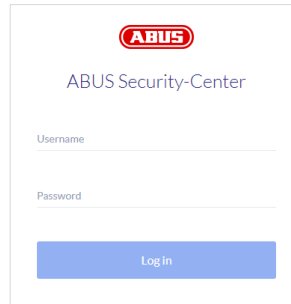

The login form features the ABUS logo at the top, followed by the text "ABUS Security-Center". Below this are two input fields: "Username" and "Password". A blue "Log In" button is positioned at the bottom of the form.

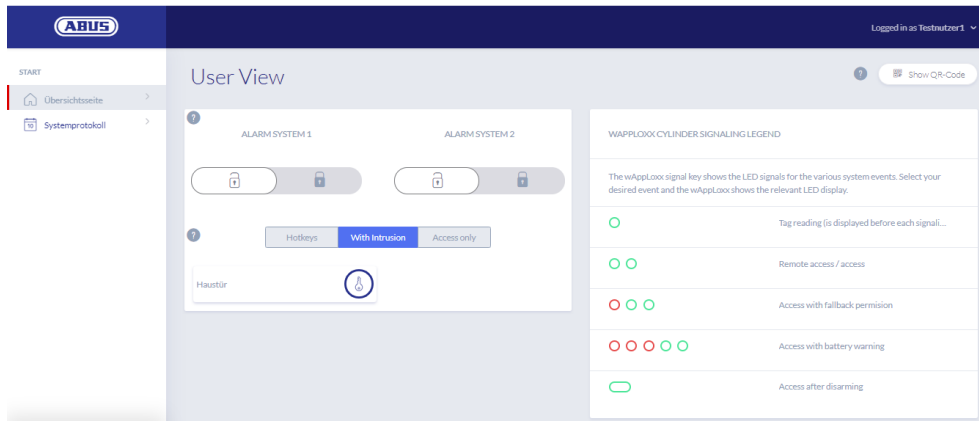

Users are required to change their password after starting up for the first time. Later, it is possible to change the password in the menu item System settings by selecting the user name ("Logged in as ...").

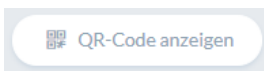

Show the QR code to connect to the wAppLoxx Pro Plus app

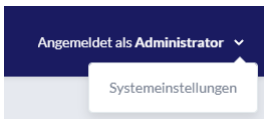

Change the user password
Unpair or delete the tag

11.1. Remote functions

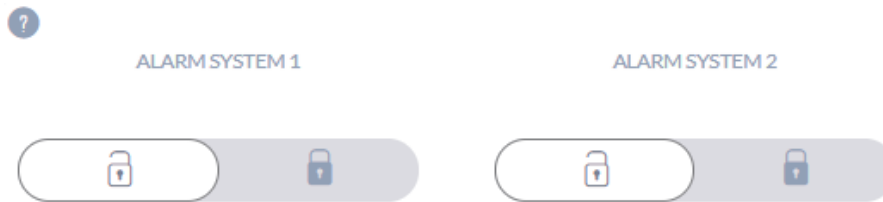

Click this button to arm or disarm a connected alarm system. You can configure two alarm systems. This takes all settings from Chapter 10.1 into consideration.

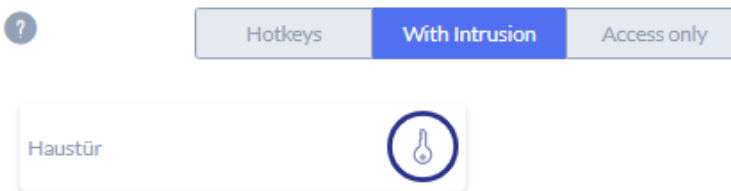

This button activates the remote control function of the wAppLoxx Pro Cylinder for 30 seconds. Pressing it again stops the function immediately. After activating the remote opening function, the outer knob on the wAppLoxx Pro Cylinder must be turned to carry out an opening. Only doors for which the user has access permission are shown. Intrusion cylinders are greyed out when alarm system is armed and the remote control function can only be used after the alarm system is deactivated.



For Access cylinders, the remote control function can also be used when the alarm system is armed.

11.2. Protocol/Event Log

To protect sensitive personal data, the wAppLoxx Pro Control Plus can be configured so that the event log is only displayed after a second authorised user logs in. The two men role mode can be established in the system settings under System access.

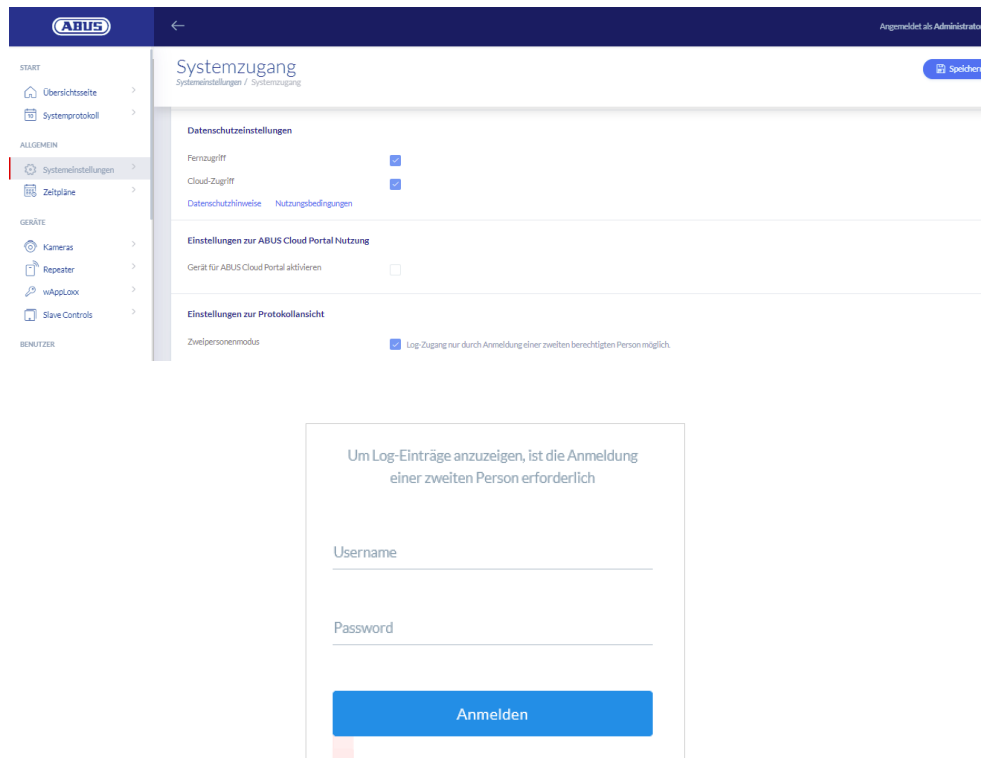

Possible event entries

- Access granted
- User logged in
- Access denied
- Two men role mode
- Remote Access
- Login failed
- Unknown tag
- System start-up
- Armed
- System restart
- Disarmed
- Reset to factory default
- Battery warning
- External input
- Supervision failure
- Tamper
- Repeater registered
- Internet connected
- Repeater deleted
- Internet disconnected
- Repeater cover tamper
- wAppLoxx created
- Repeater Power Loss
- wAppLoxx deleted
- Repeater Power Back
- Disable secure mode
- Administrator logged in
- Secure Mode Activated
- Slave control added
- Slave control deleted

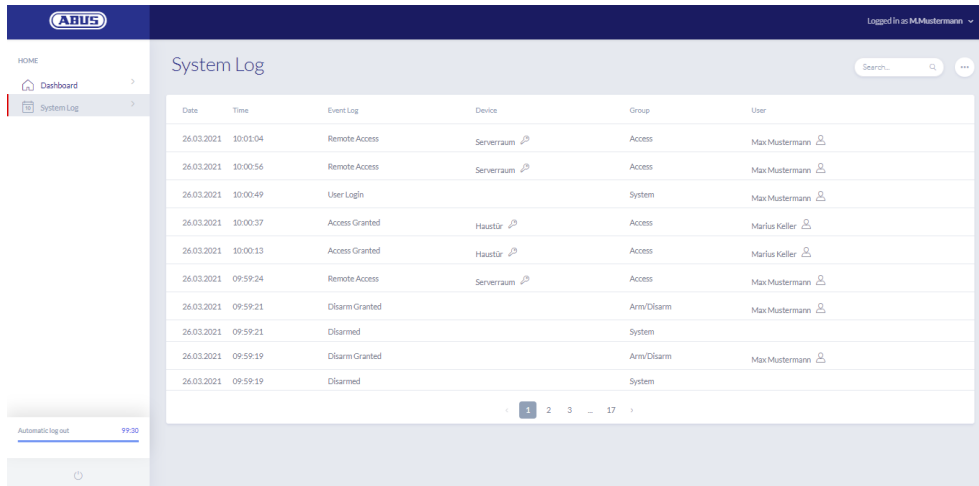

The screenshot shows the ABUS System Log interface. The header includes the ABUS logo, the text "Logged in as MM-Mustermann", and a search bar. The main content is a table with columns for Date, Time, Event Log, Device, Group, and User. The table contains 10 rows of log entries. A navigation bar at the bottom of the table shows page numbers 1, 2, 3, and 17.

Date	Time	Event Log	Device	Group	User
26.03.2021	10:01:04	Remote Access	Serverraum	Access	Max Mustermann
26.03.2021	10:00:56	Remote Access	Serverraum	Access	Max Mustermann
26.03.2021	10:00:49	User Login		System	Max Mustermann
26.03.2021	10:00:37	Access Granted	Hautür	Access	Marlus Keller
26.03.2021	10:00:13	Access Granted	Hautür	Access	Marlus Keller
26.03.2021	09:59:24	Remote Access	Serverraum	Access	Max Mustermann
26.03.2021	09:59:21	Disarm Granted		Arm/Disarm	Max Mustermann
26.03.2021	09:59:21	Disarmed		System	
26.03.2021	09:59:19	Disarm Granted		Arm/Disarm	Max Mustermann
26.03.2021	09:59:19	Disarmed		System	

12. wAppLoxx Pro Plus App

To control the wAppLoxx Pro Plus system, a mobile app can be used that can be downloaded from the App Store (iOS) or the Play Store (Android). To set up the wAppLoxx Pro Plus App, the user must first have web access, created by the administrator (see chapter 8.2).

12.1. Configuration of the wAppLoxx Pro Plus App

During initial start-up, the wAppLoxx Pro Control Plus is automatically configured to encrypt the connection from all mobile devices that are added later. Proceed as follows:

1. Installing the wAppLoxx Pro Plus App

Scan the QR code with your smartphone and open the link displayed. Alternatively, you can also find the ABUS wAppLoxx Pro Plus app in your App Store (iOS) or Play Store (Android). Install the app on your smartphone.

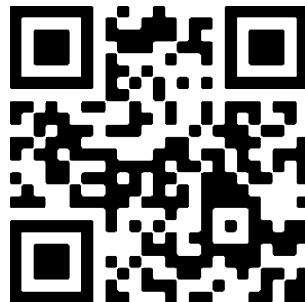

2. Adding the wAppLoxx Pro Control Plus

After installing the wAppLoxx Pro Plus app, the control must be added in the app once. Click the button "Add wAppLoxx Pro Plus". There are then three ways to add the control in the app.

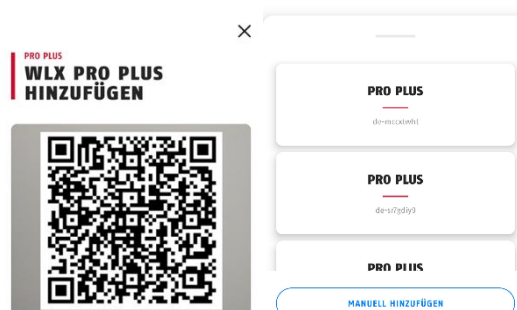

2a. Add with the QR code



For security reasons, the QR codes are only valid for one week and each QR code can only be used once.

You can access the QR code in four different ways:

- in the wAppLoxx Pro Plus Manager

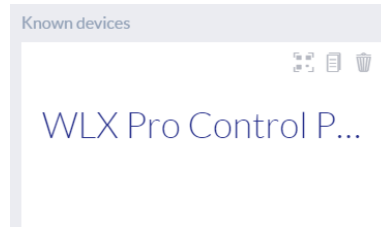

In the wAppLoxx Pro Plus Manager, the icon for generating a QR code is displayed above the wAppLoxx Pro Control Plus. Click on the icon and scan the QR code in the app with your smartphone.

Then enter the user name and password set by the administrator. This adds the wAppLoxx Pro Control Plus to your app.

- as administrator in the user overview

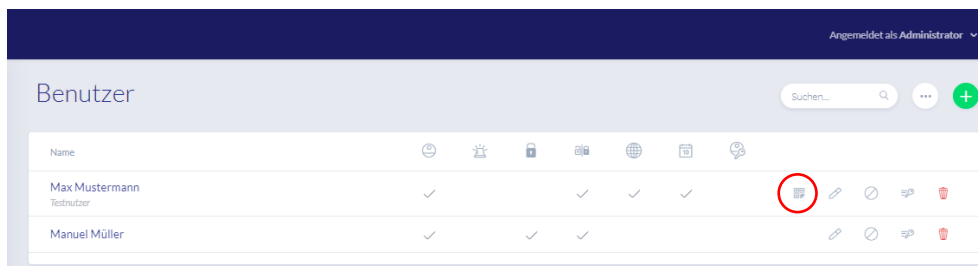

All users who are allowed to access the control via the app must first be approved for web access by the administrator. A QR code icon is then displayed in the user overview. Click on the icon and scan the QR code with your smartphone. The QR code is personalised to you, so you do not need a user name and password to log in for the first time. After scanning, the wAppLoxx Pro Control Plus is added to your app.

- as a user on your user interface

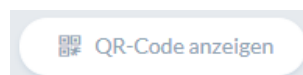

Log in with your user data as described in chapter 11. User data is created in the administrator user menu (see Chapter 8.1). Click on the Show QR Code icon and scan the QR code with your smartphone. The QR code is personalised to you, so you do not need a user name and password to log in. After scanning the QR code, the wAppLoxx Pro Control Plus is added to your app. Then log out of the user interface so that you can log in to the app.

- in the wAppLoxx Pro Plus app of another user

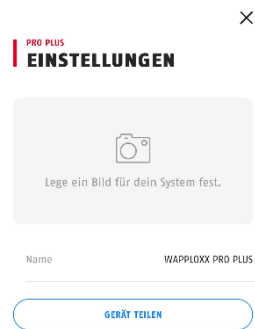

Users who have already added the wAppLoxx Pro Control Plus to their app can share it with other users. This can be done in the control's settings. By clicking on the "Share Device" button, the user can generate a QR code. Scan the QR code with your smartphone. Then enter the user name and password set by the administrator. Then the wAppLoxx Pro Control Plus is added to your app.

2b. Adding in the local network

If you are logged into the same network as the wAppLoxx Pro Control Plus with your smartphone, all controls available in this network will be displayed below the camera window.

Select your control and enter your user name and password to add the control.

2c. Add via the Device ID

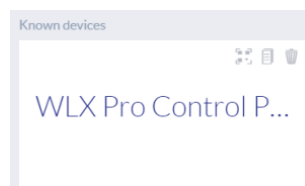

In the wAppLoxx Pro Plus Manager, click on the middle icon of the three icons above the control you found. A message will appear that the device ID has been copied. In your app, click Add manually and add the Device ID from the Manager.

Then enter the user name and password set by the administrator. Then the wAppLoxx Pro Control Plus is added to your app.



Please assign a new password after the first login (see chapter 12.2).

After adding, the wAppLoxx Pro Control Plus will be displayed on the overview page together with your user name.

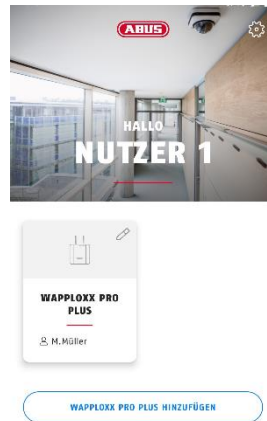

3. wAppLoxx Pro Plus App Settings

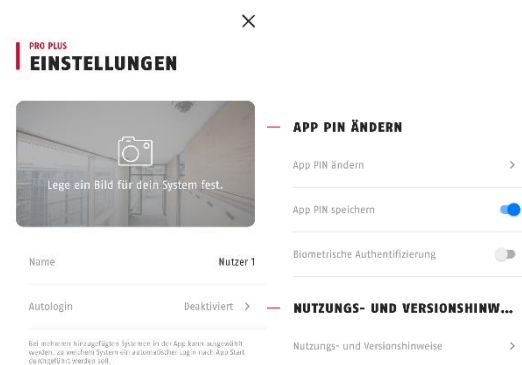

Image selection

You can insert a picture of the location of your wAppLoxx Pro system.

Name

Enter your individual user name here.

Auto-login

You can select whether you want to log into your wAppLoxx Pro Control Plus automatically after starting the app. If you are operating several controls, you can specify the control into which you should be automatically logged in.

Change App PIN

To change the app PIN, you must enter your previous PIN, then you can set your new app PIN. You have the option of saving the app PIN or setting fingerprint authentication.

12.2. Functions of the wAppLoxx Pro Plus App

wAppLoxx Pro Control Plus Settings

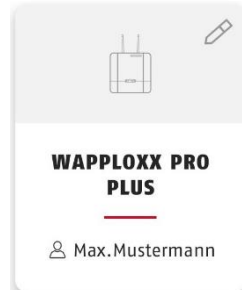

After adding, your control will appear on the overview page of the wAppLoxx Pro Plus app. Use the stylus at the top right of the tile to access the wAppLoxx Pro Control Plus settings.

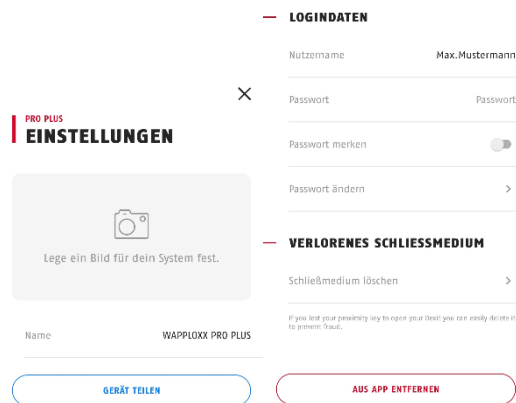

Figure

You can set an image of the installation location of your wAppLoxx Pro Control Plus.

Share device

You can generate a QR code yourself in your wAppLoxx Pro Plus app. Other users can scan this with their smartphone in the wAppLoxx Pro Plus app to add the control in your app for the first time (see chapter 12.1).



The user with whom the access is shared must also have been approved for web access by the administrator.

User name and password

Your user name has been set by the administrator. Your password will be represented by dots if you have selected the Remember Password option.

Change password

Enter your old password and then set your new password. Please change your password after the first login.

Delete tag

If you have lost your tag, you can delete it in the app. A password confirmation is required to delete a tag.

The administrator can reprogram and reassign the tag to a user.

Remove from App

Use this button to delete the wAppLoxx Pro Control Plus from your app.

Remote door opening

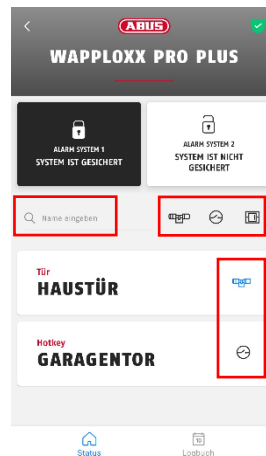

Navigation aids

Search function: All cylinders, hotkeys and wall readers are displayed on the overview page. You can search for a specific door component in the "Enter name" field.

Filter function: To the right of the search function, the three icons for cylinders, hotkeys and wall readers are displayed. By clicking on these icons, you can show or hide all components of these categories.

Pin favourites: By clicking on the icon to the right of a door component, you can pin it as a favourite. This highlights the component in blue and always displays it at the top of the list of door components.

Click on the lettering of the door to open it remotely. If a camera has been configured for this door by the administrator, a current snapshot will be displayed. Confirm the opening by clicking on "Release".

The remote opening function of the wAppLoxx Pro cylinder will then be activated for 30 seconds. Pressing it again stops the function immediately. After activating the remote opening function, the outer knob on the wAppLoxx Pro Cylinder must be turned to carry out an opening.

Trigger hotkeys



If a hotkey has been configured, you will see it in the overview of all door components. Click on the lettering (e.g. Garage door) to trigger the hotkey. A confirmation that the hotkey has been triggered will appear.

Viewing and exporting logbook entries

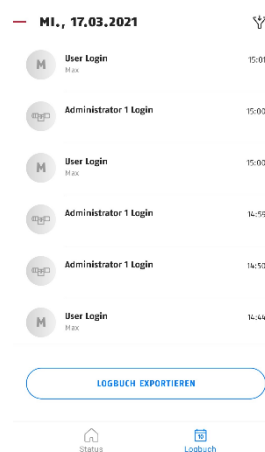

View logbook entries

If you have been created by the administrator as a user with log access, you can switch from the status view to the log view in the lower area of the app.



If you do not have access rights, the tile Logbook will not be displayed.



When two men role mode is activated, the Logbook tile is displayed, but you cannot view any logbook entries in the app.

Export logbook entries

By clicking on the button "Export logbook" you can export the logbook entries as a PDF file. The logbook type (accesses, arming/disarming, recordings, system messages) and the

number of entries to be exported can be selected. After confirmation, you will receive a PDF file with the selected entries.

Arming/disarming the alarm system



If alarm systems have been configured, they will be displayed in the app. The alarm systems can have the status Secured (black background) or Unsecured (white background). The alarm system can be armed or disarmed by clicking on the tile. If you do not have authorisation to arm or disarm the alarm system, the message "Missing permissions" will appear.

Camera functions

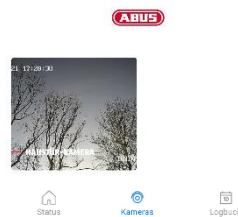

After cameras have been set up by the administrator (see chapter 9), they can be accessed in the wAppLoxx Pro Plus app. After setting up, the "Camera" tile will appear between the overview and logbook tiles. On the overview page you can see all installed cameras.



By clicking on one of the installed cameras, you can open the live stream. In the live stream, you can zoom in or out with your fingers.

You can access the following functions by clicking the icons at the bottom of the screen:



Switch between low and high resolution of the live stream.



Create a snapshot of the currently open camera.



View snapshots created in the past, in the app and via events.



Explanations of other camera functions.

13. Terms of use for wAppLoxx Pro Plus

Scope of the Terms of Use

These terms of use apply to the use of the application of the ABUS Security Center GmbH & Co. KG (hereinafter "ABUS Security Center"),
Linker Kreuthweg 5
86444 Affing

The use of the application is exclusively based on these terms of use.

ABUS Security Center is free to provide services in connection with this use by third parties.

13.1 Scope of application

By installing and subsequently using the application offered by the ABUS Security Center, the user accepts the following terms of use as amended from time to time. The terms and conditions also apply to future updates or new versions of the software of the application.

13.2 Subject of agreement

ABUS Security Center grants the user a non-transferable right to use the software. The right of use is subject to the conditions regulated herein.

The wAppLoxx Pro Plus Manager is used to configure a wAppLoxx Pro Plus access control system. The corresponding data is transmitted directly to the control unit via a secure connection so that it can control access and other connections accordingly. ABUS Security Center provides the wAppLoxx Pro Plus Manager free of charge.

Using the wAppLoxx Pro Plus mobile app, users who have received the appropriate authorisation can remotely release components and view camera images. This establishes a secure connection between the app and the control unit. ABUS Security Center provides the app as a subscription model (monthly/yearly) or as a one-time purchase.

13.3 Technical usage requirements and application updates

The fulfilment of the technical usage and system requirements is the sole responsibility of the user. In order to use the software, the user requires an end device that meets the applicable system and compatibility requirements for the corresponding software version.

The application can be downloaded from abus.com and updated as new versions become available. Updates are used to correct any program errors. The functionality and scope of services are generally not impaired or changed by such updates.

13.4 Duties of care of the users

Access data must be kept secret by the user. In particular, the user must ensure that no unauthorised third party obtains knowledge of their password. The user is also obliged to use the application exclusively within the framework of these terms of use.

The user undertakes to inform ABUS Security Center immediately if and insofar as they become aware or suspect that unauthorised third parties have knowledge of the login data assigned to them or created by them. The user shall also immediately change the login data assigned to them and the login data created by them or have it reset by ABUS Security Center after showing proof of their identity if they suspect that unauthorised third parties may have knowledge of this login data.

The user will not install any software on their end device or modify the application in such a way that is suitable for intercepting, modifying, recording or unauthorised storage of data from ABUS Security Center or other users in the course of using the application or on a system connected to it.

13.5 Warranty and liability

For the free use of the application, ABUS Security Center does not assume any guarantee for the proper functioning and permanent availability of the application.

Any liability for damages on the part of ABUS Security Center with the provision of the free application, irrespective of the legal grounds, shall be limited, to the extent permitted by law, to cases of intent or gross negligence.

In the case of chargeable use and chargeable app functionalities that are offered or advertised as a product feature of hardware products sold by ABUS Security Center, the statutory warranty conditions apply with the proviso that the app is sufficiently tested and has the specified functions.

13.6 Data protection

The current data protection regulations apply.

ABUS Security Center complies with the applicable data protection regulations when collecting, using and processing personal data.

The user consents to ABUS Security Center's collection, processing and use of personal data in compliance with the relevant laws in order to make the use of the application possible and accessible to the user.

The operator is the entity responsible for ensuring the legally compliant use of the product in accordance with the GDPR.

ABUS Security Center strives to continuously improve the use and functions of the application. Optimisations in this regard are made through updates, which are downloaded and installed. The user agrees to receive news and notices about these optimisations.

13.7 Final provisions

The law of the Federal Republic of Germany shall apply.

The place of jurisdiction shall be the registered office of ABUS Security Center.

ABUS Security Center reserves the right to amend these Terms of Use if necessary for factual reasons.

In this case, ABUS Security Center will inform the user of the change in good time and request the user's consent. Further use of the application may be made dependent on consent.

Should individual provisions of these Terms of Use be or become invalid, this shall not affect the validity of the remaining provisions.

The invalid or void provision shall be replaced by a valid/effective provision that comes as close as possible to the economic purpose of the invalid or void provision.

14. Open Source Licence information

The product contains software components that are licenced by the rights holders as free software or open source software (hereinafter referred to as "OSS"). The corresponding licences are enclosed with the product in printed form and/or can be accessed via a graphical user interface and/or transfer to a USB stick. You can acquire usage rights to the extent regulated there directly from the rights holders.

The open source licences take precedence over all other licence conditions and contractual agreements with ABUS in respect of the corresponding OSS software components contained in the product.

In general, licensing information on ABUS products can be found at www.abus.com in the download area of the product description.

Retrieving the open source licence information from your wAppLoxx Pro Control Plus

1. Remove the power supply from your wAppLoxx Pro Control Plus and insert a USB stick into the USB interface.
2. Then restore the power supply.
3. After the wAppLoxx Pro Control Plus has started (LED 1 lights up green continuously), you can remove the USB stick; the open source licence information has been saved on it.

15. Disposal instructions



Devices displaying this symbol may not be disposed of with domestic waste. At the end of its lifespan, dispose of the product according to the applicable legal requirements. Please contact your dealer or dispose of the products at the local collection point for electronic waste.

If you have any technical questions, please contact your specialist dealer.

ABUS Security Center GmbH & Co. KG
Linker Kreuthweg 5
86444 Affing • Germany